

INSTRUCTION MANUAL

RA 50

MAT POWER MODULE RACK ADAPTER

KEPCO INC.
An ISO 9001 Company.

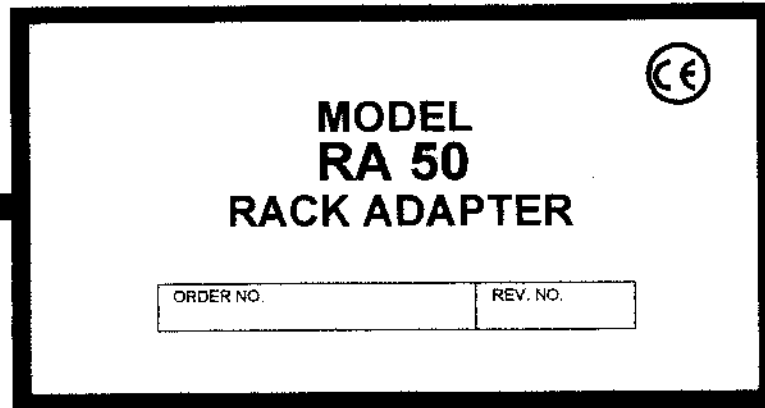

IMPORTANT NOTES:

- 1) This manual is valid for the following Model and associated serial numbers:

MODEL	SERIAL NO.	REV. NO.
-------	------------	----------
- 2) A Change Page may be included at the end of the manual. All applicable changes and revision number changes are documented with reference to the equipment serial numbers. Before using this Instruction Manual, check your equipment serial number to identify your model. If in doubt, contact your nearest Kepco Representative, or the Kepco Documentation Office in New York, (718) 461-7000, requesting the correct revision for your particular model and serial number.
- 3) The contents of this manual are protected by copyright. Reproduction of any part can be made only with the specific written permission of Kepco, Inc.

Data subject to change without notice.

©2000, KEPSCO, INC.
P/N 243-0776



KEPCO, INC. • 131-38 SANFORD AVENUE • FLUSHING, NY. 11352 U.S.A. • TEL (718) 461-7000 • FAX (718) 767-1102
email: hq@kepcopower.com • World Wide Web: <http://www.kepcopower.com>

Declaration of Conformity

Application of Council directives: **73/23/EEC (LVD)**
93/68/EEC (CE mark)

Standard to which Conformity is declared:

EN61010-1:2001 (Safety requirements for electrical equipment for measurement, control and laboratory use - Part 1)

Manufacturer's Name and Address: **KEPCO INC.**
131-38 SANFORD AVENUE
FLUSHING, N.Y. 11352 USA

Importer's Name and Address:

REPRESENTATIVE COPY

Type of Equipment: **Rack Adapter**

Model No.: *[PRODUCT MODEL NUMBER]*

Year of Manufacture:

I, the undersigned, declare that the product specified above, when used in conjunction with the conditions of conformance set forth in the product instruction manual, complies with the requirements of the Low Voltage Directive 73/23/EEC, which forms the basis for application of the CE Mark to this product.

Place: **KEPCO, Inc.**
131-38 Sanford Ave.
Flushing, N.Y.11352 USA

Saul Kupferberg
(Full Name)

Date: _____

VP OF SALES
(position)

Conditions of Conformance Rack Adapter products (EN61010-1)

When this product is used in applications governed by the requirements of the EEC, the following restrictions and conditions apply:

1. For European applications, requiring compliance to the Low Voltage Directive, 73/23/EEC, this Rack Adapter is considered a component, designed for "built in" applications. Because it is incomplete in construction, the end product enclosure must provide for compliance to any remaining electrical safety requirements and act as a fire enclosure. (EN61010-1:2001, Cl. 6, Cl. 7, Cl.8, and Cl. 9)
2. This Rack Adapter is designed for stationary installation, with mains power applied via a detachable power supply cord or via direct wiring to the source power terminal block.
3. This Rack Adapter, when properly installed, is considered a Class 1 (earthed) product. It is intended for use as part of equipment meant for test, measurement and laboratory use, and is designed to operate from single phase, three wire power systems. This equipment must be installed within a suitably wired equipment rack, utilizing a three wire (grounded) mains connection. See wiring section of this manual for complete electrical wiring instructions. (EN61010-1:2001, Cl.6.10.1)
4. This power supply has secondary output circuits that are considered hazardous, and which exceed 240 VA at a potential of 2V or more.
5. The output wiring terminals of this power supply has not been evaluated for field wiring and, therefore, must be properly configured by the end product manufacturer prior to use.
6. For complete circuit protection of the end product, as well as the building wiring, it is required that a primary circuit protection device be fitted to the branch circuit wiring. (EN61010-1:2001 Cl. 9.5)
7. When installed with other components and/or power supplies, hazardous voltages may be present within during normal operation. All operator adjustments are made via externally accessible switches, controls and signal lines as specified within the individual power supply operating instructions. There are no user or operator serviceable parts within this product enclosure. Refer all servicing to qualified and trained Kepco service technicians.

SAFETY INSTRUCTIONS

1. Installation, Operation and Service Precautions

This product is designed for use in accordance with EN 61010-1 and UL 3101 for Installation Category 2, Pollution Degree 2. Hazardous voltages are present within this product during normal operation. The product should never be operated with the cover removed unless equivalent protection of the operator from accidental contact with hazardous internal voltages is provided:



There are no operator serviceable parts or adjustments within the product enclosure. Refer all servicing to trained service technician.



Source power must be removed from the product prior to performing any servicing.



This product is factory-wired for the nominal a-c mains voltage indicated on the rating nameplate located adjacent to the source power connection on the product's rear panel. To reconfigure the product input for other nominal mains voltages as listed herein, the product must be modified by a trained service technician.

2. Grounding

This product is a Class 1 device which utilizes protective earthing to ensure operator safety.



The PROTECTIVE EARTHING CONDUCTOR TERMINAL must be properly connected prior to application of source power to the product (see instructions on installation herein) in order to ensure safety from electric shock.



PROTECTIVE EARTHING CONDUCTOR TERMINAL - This symbol indicates the point on the product to which the protective earthing conductor must be attached.



EARTH (GROUND) TERMINAL - This symbol is used to indicate a point which is connected to the PROTECTIVE EARTHING TERMINAL. The component installer/ assembler must ensure that this point is connected to the PROTECTIVE EARTHING TERMINAL.

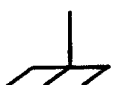

CHASSIS TERMINAL - This symbol indicates frame (chassis) connection, which is supplied as a point of convenience for performance purposes (see instructions on grounding herein). This is not to be confused with the protective earthing point, and may not be used in place of it.

3. Electric Shock Hazards

This product outputs hazardous voltage and energy levels as a function of normal operation. Operators must be trained in its use and exercise caution as well as common sense during use to prevent accidental shock.



This symbol appears adjacent to any external terminals at which hazardous voltage levels as high as 500V d-c may exist in the course of normal or single fault conditions.



This symbol appears adjacent to any external terminals at which hazardous voltage levels in excess of 500V d-c may exist in the course of normal or single fault conditions.

TABLE OF CONTENTS

PARAGRAPH	PAGE
I GENERAL DESCRIPTION	1
II ELECTRICAL CONNECTIONS.....	1
III AC INPUT POWER CONNECTOR	1
IV CONTROL BUS	1
V INSTALLATION	2
VI ACCESSORIES PROVIDED	2
VII ACCESSORIES AVAILABLE	2

LIST OF ILLUSTRATIONS

FIGURE	PAGE
1 MECHANICAL OUTLINE DRAWING FOR THE RA 50 RACK ADAPTER	3
2A REAR CONNECTORS ON THE BACK PANEL OF RACK ADAPTER RA 50 (LOOKING INSIDE THE RACK ADAPTER).....	4
2B REAR CONNECTORS ON THE BACK OF THE RACK ADAPTER RA 50 (VIEWING THE TOP OF THE RACK ADAPTER)	4
3 ELECTRICAL WIRING DIAGRAM FOR THE RA 50 RACK ADAPTER	5
4 FRONT VIEW OF A 1/3 RACK SIZE MAT POWER MODULE	6
5 REAR VIEW OF A 1/3 RACK SIZE MAT POWER MODULE SHOWING THE DC OUTPUT CONNECTOR AND CONTROL BUS-AC INPUT CONNECTOR	7

I GENERAL DESCRIPTION

The Kepco Model RA 50 RACK ADAPTER is designed for the installation of Kepco MAT Power Modules into a standard 19-inch rack. The Rack Adapter occupies 5¼ inches of vertical space in the standard 19-inch equipment rack and is 25-inches deep.

The Rack Adapter may be mounted stationary or may be equipped with optional equipment slides. It was developed to provide mounting space for Kepco's 360W - Rack Power Modules. It houses up to three 1/3 Rack Modules. The Rack Adapter may be equipped with front Filler Panels. The RFP 50-1 Filler Panel can be used to close one channel in the RA 50 or RA 51 Rack Adapter. Filler Panel RFP 50-2 can be used to close two channels in the RA 50 or RA 51 Rack Adapters. To transport the MAT Power Modules in the Rack Adapter RA 50, each Power Module must be secured with six screws. A packet of 18 Flat Head Phillips Screws (Kepco P/N 101-0421) is provided for this purpose.

Mechanical dimensions, material and finish of the Kepco Model RA 50 Rack Adapter is provided in FIG. 1 (Mechanical Outline Drawing).

II ELECTRICAL CONNECTIONS

The electrical connections made by the RA 50 include (see FIG. 3 for Electrical Wiring Diagram):

- 1) AC power distribution to the three 1/3 Rack MAT Power Modules
- 2) Safety ground distribution to the three 1/3 Rack MAT Power Modules
- 3) Control Bus distribution to the three 1/3 Rack MAT Power Modules

The MAT Power Module connects to the RA 50 Rack Adapter via a six prong connector. Two prongs are for the AC input power, two are for the Control Bus, one is for Safety Ground, and the last one is not used.

III AC INPUT POWER

The AC input power connector (male receptacle) accepts a three prong AC input female plug (supplied). Two prongs are for the AC input power; the third prong is for Safety Ground and is connected to the chassis of the unit. The wire used to connect the RA 50 to the AC input power must be capable of carrying the total required AC input current of all the Power Modules in the RA 50 Rack Adapter.

IV CONTROL BUS

The Control Bus Connectors connect the MAT Power Module to the Control Bus.

The Control Bus is a high speed (375 KHz) bidirectional communications link between the TMA 488-27 Power Module Controller and all the MAT Power Modules. The TMA 488-27 Power Module Controller is the interface between the Host Computer and all the MAT Power Modules on the Control Bus. The control of all the MAT Power Modules (sending and receiving data) from the Host Computer is realized via the TMA 488-27.

Rack Adapters RA 50 and RA 51 have Control Bus Connectors J1 and J2 on the back of the Rack Adapter (see Figure 2B). These connectors are electrically connected in parallel (via Rack Adapter Connectors J4, J5, and J6) with the Control Bus Connectors on the rear panel of the MAT Power Module (1/3 Rack size or 2/3 Rack size).

The MAT Full Rack size Power Module also has two connectors on the Rear Panel of the unit for Control Bus Input and Output. The TMA 488-27 Power Module Controller and up to 27 MAT Power Modules (housed either in Rack Adapter RA 50 or RA 51 or the Full Rack size MAT Power Module) can be connected in a Daisy Chain configuration via the above mentioned Control Bus Input and Output connectors.

One 2-meter long shielded twisted pair cable with two mating connectors, one at each end (Kepco P/N 118-0699) is supplied with each Rack Adapter (RA 50 or RA 51) and with each Full Rack size MAT Power Module for this purpose.

The last (in the Daisy chain) Power Module or Rack Adapter RA 50 or RA 51 Control Bus Outlet must be terminated with a terminating Connector Assembly (Kepco P/N 195-0075) that is supplied with the TMA 488-27.

For further information contact your Kepco Representative or Kepco at 131-38 Sanford Avenue, Flushing, New York 11352 USA.

V INSTALLATION

CAUTION

RACK ADAPTER SHOULD BE MOUNTED AND FASTENED SECURELY TO RACK BEFORE INSTALLING POWER SUPPLIES TO AVOID DISTORTION OF THE RACK ADAPTER. (INSTALL POPULATED RACK ADAPTER ONLY IF BOTTOM OF RACK ADAPTER IS FULLY SUPPORTED.) FAILURE TO OBSERVE THIS CAUTION MAY RESULT IN MISALIGNMENT OF THE POWER SUPPLIES WITH THE RACK ADAPTER.

VI ACCESSORIES PROVIDED

One 2-meter long shielded twisted pair cable with two mating connectors (Kepco P/N 118-0699)
One AC Input Power Mating Connector (Kepco P/N 142-0357)
18 Flat head Phillips Screws (Kepco P/N 101-0421)

VII ACCESSORIES AVAILABLE

Filler Panel RFP 50-1 (one channel)
Filler Panel RFP 50-2 (two channel)

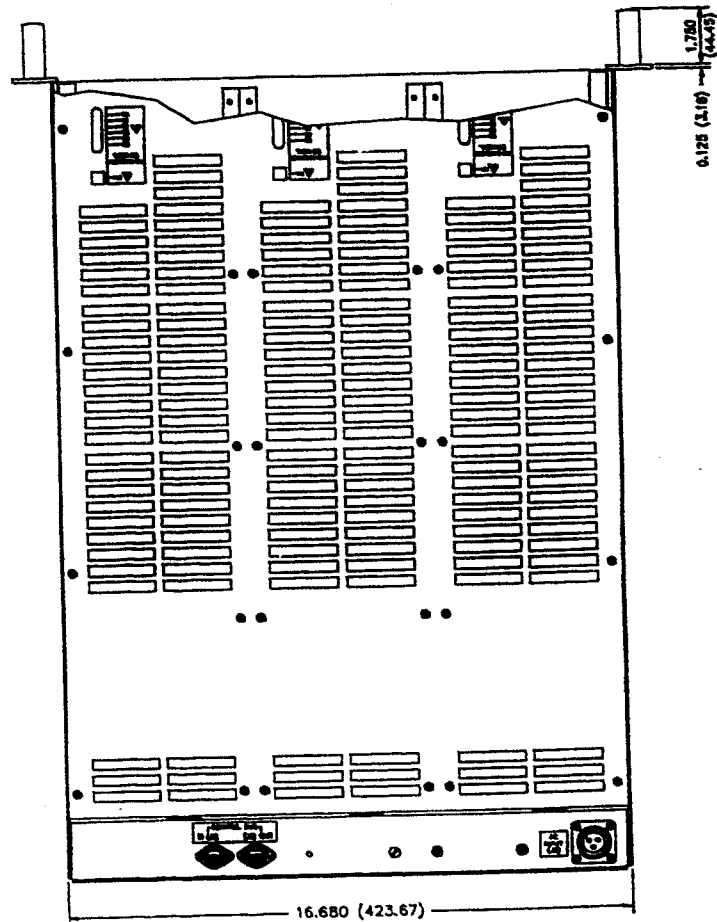
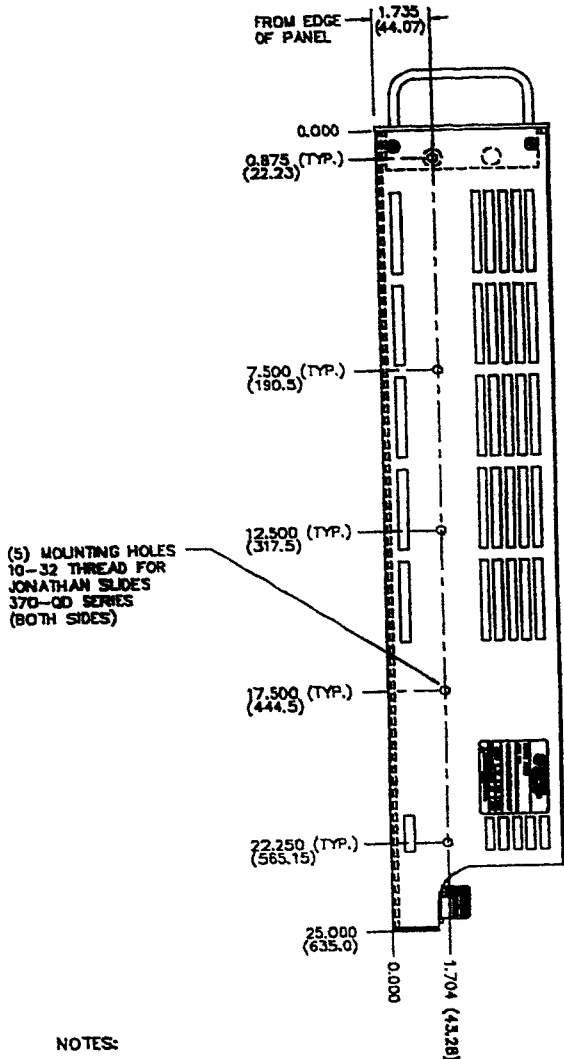
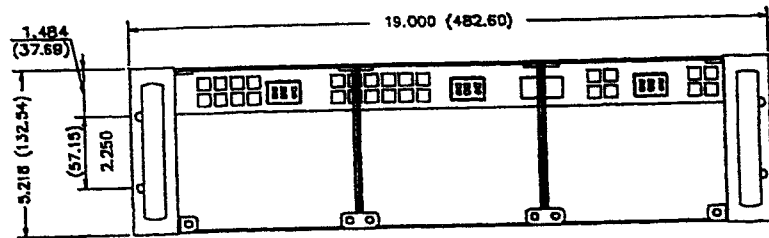

NOTES:

1. MATERIAL:
 - A) RACK ADAPTER, CHANNEL & PARTITION: 0.090 THK. ALUM. 5052-H32.
 - B) COVER: 0.064 THK. ALUM. 5052-H32.
 - C) GUIDE BAR: 0.093 THK. ALUM. 6061-T6.
 - D) ANGLE BKT: 0.125 THK. ALUM. ANGLE 6063-T5.
2. FINISH:
 - A) RACK ADAPTER, COVER, CHANNEL, GUIDE BAR, & PARTITION YELLOW IRIDITE
 - B) ANGLE BKT: KEPKO GREY, HARTIN PAINT #15-22493.
3. IF INSTALLATION WITHOUT SLIDES IS DESIRED, THE UNIT MUST BE SUPPORTED BY A RIGID PLATFORM.
4. DIMENSIONS IN PARENTHESES ARE IN MILLIMETERS.
5. TOLERANCES:
 - A) BETWEEN MOUNTING HOLES: $\pm 1/64 (\pm 0.4)$.
 - B) ALL OTHER DIMENSIONS: $\pm 1/32 (\pm 0.8)$ EXCEPT AS NOTED.

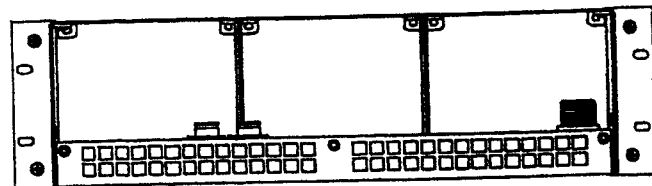
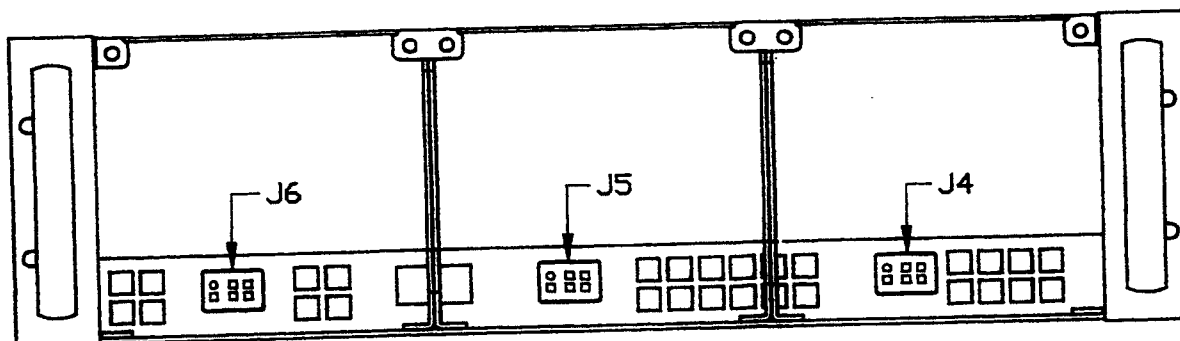
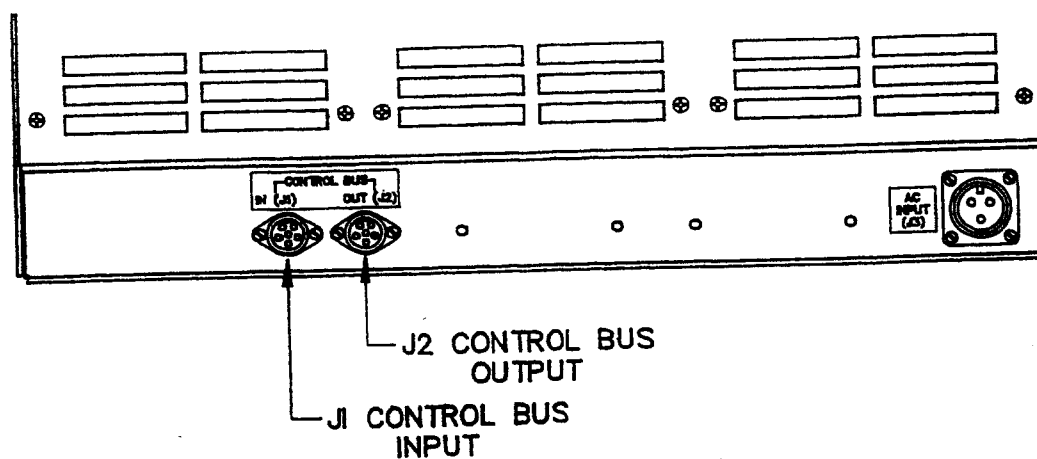

FIGURE 1 MECHANICAL OUTLINE DRAWING FOR THE RA 50 RACK ADAPTER



**FIGURE 2A REAR CONNECTORS ON THE BACK PANEL OF RACK ADAPTER RA 50
(LOOKING INSIDE THE RACK ADAPTER)**



**FIGURE 2B REAR CONNECTORS ON THE BACK OF THE RACK ADAPTER RA 50
(VIEWING THE TOP OF THE RACK ADAPTER)**

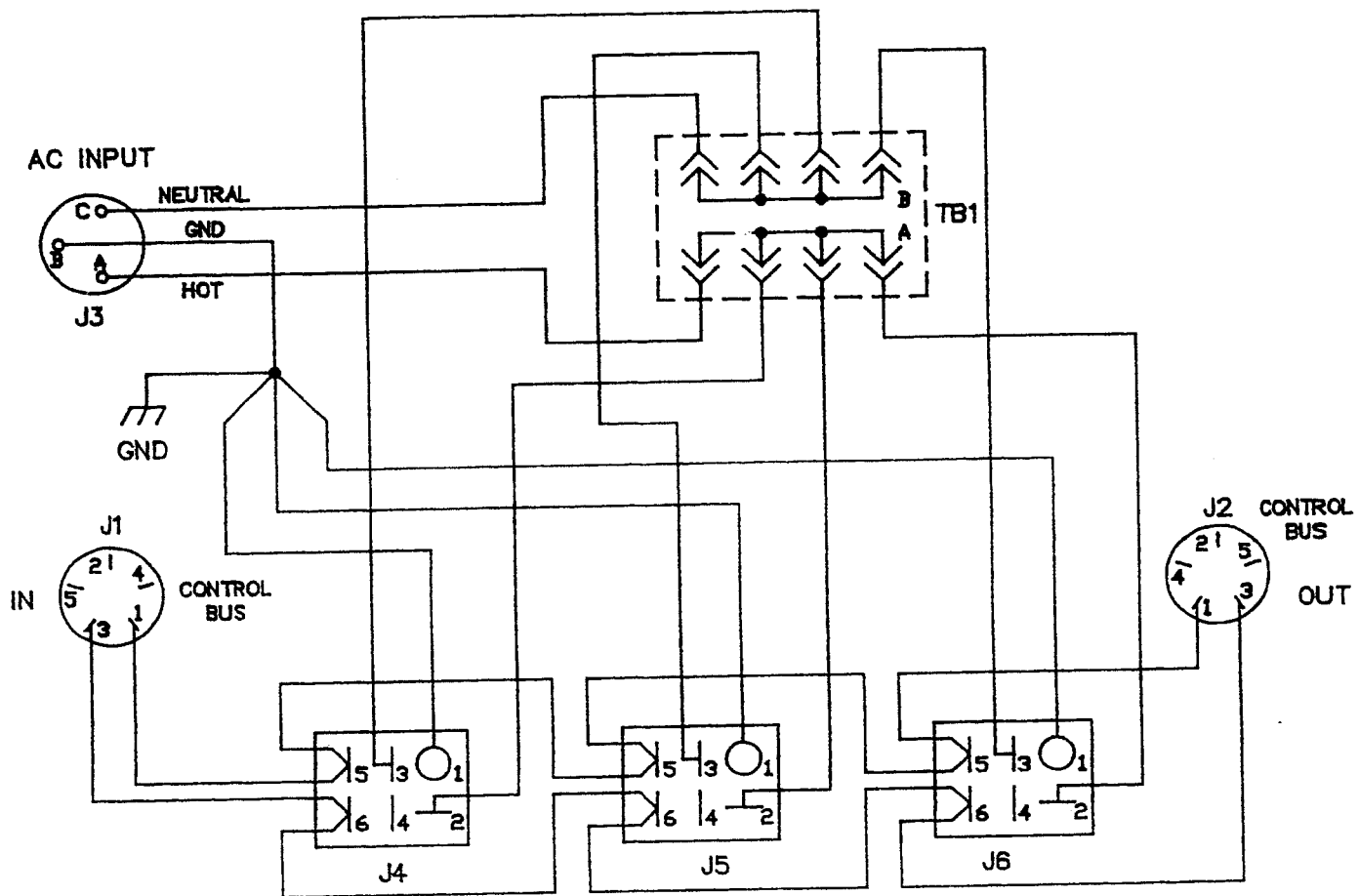

FIGURE 3 ELECTRICAL WIRING DIAGRAM FOR THE RA 50 RACK ADAPTER

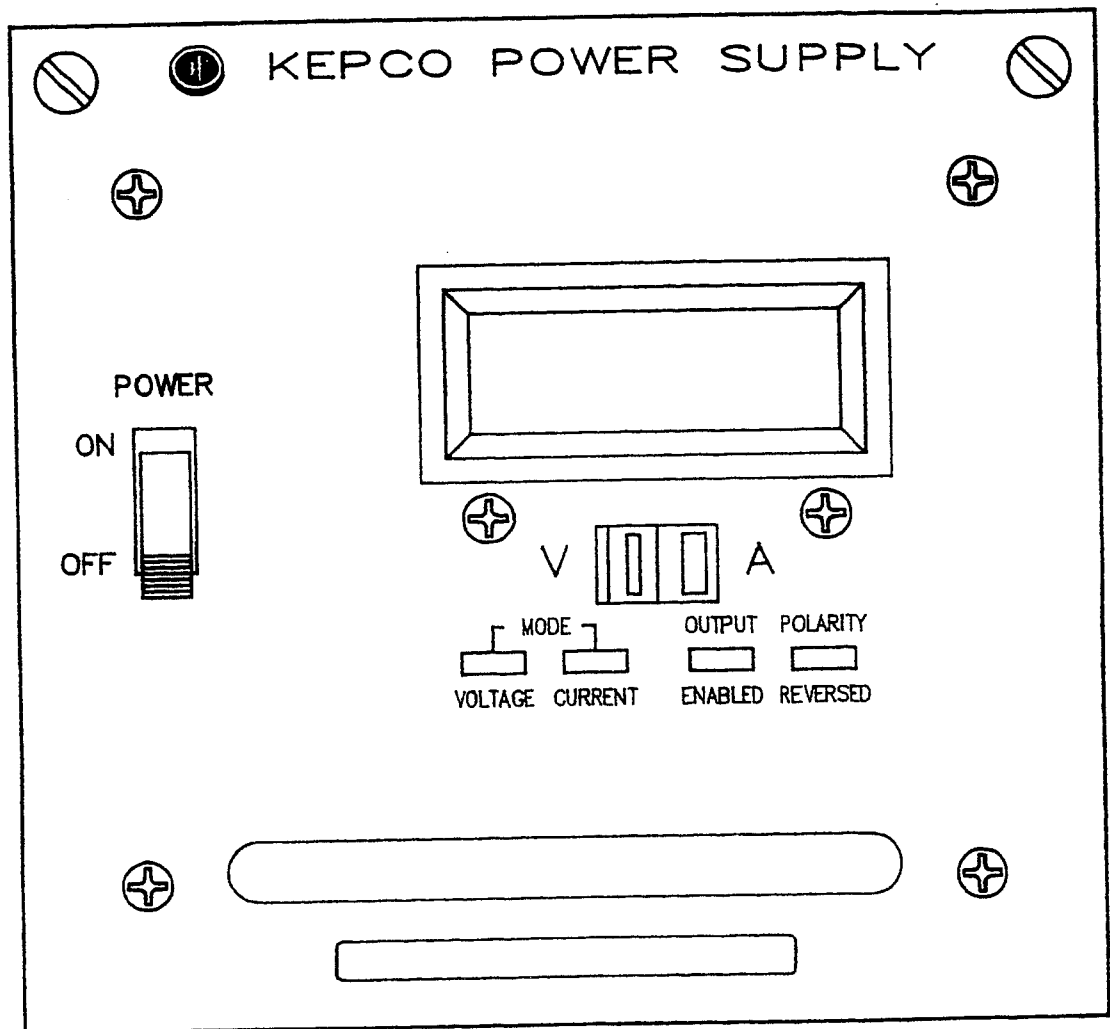
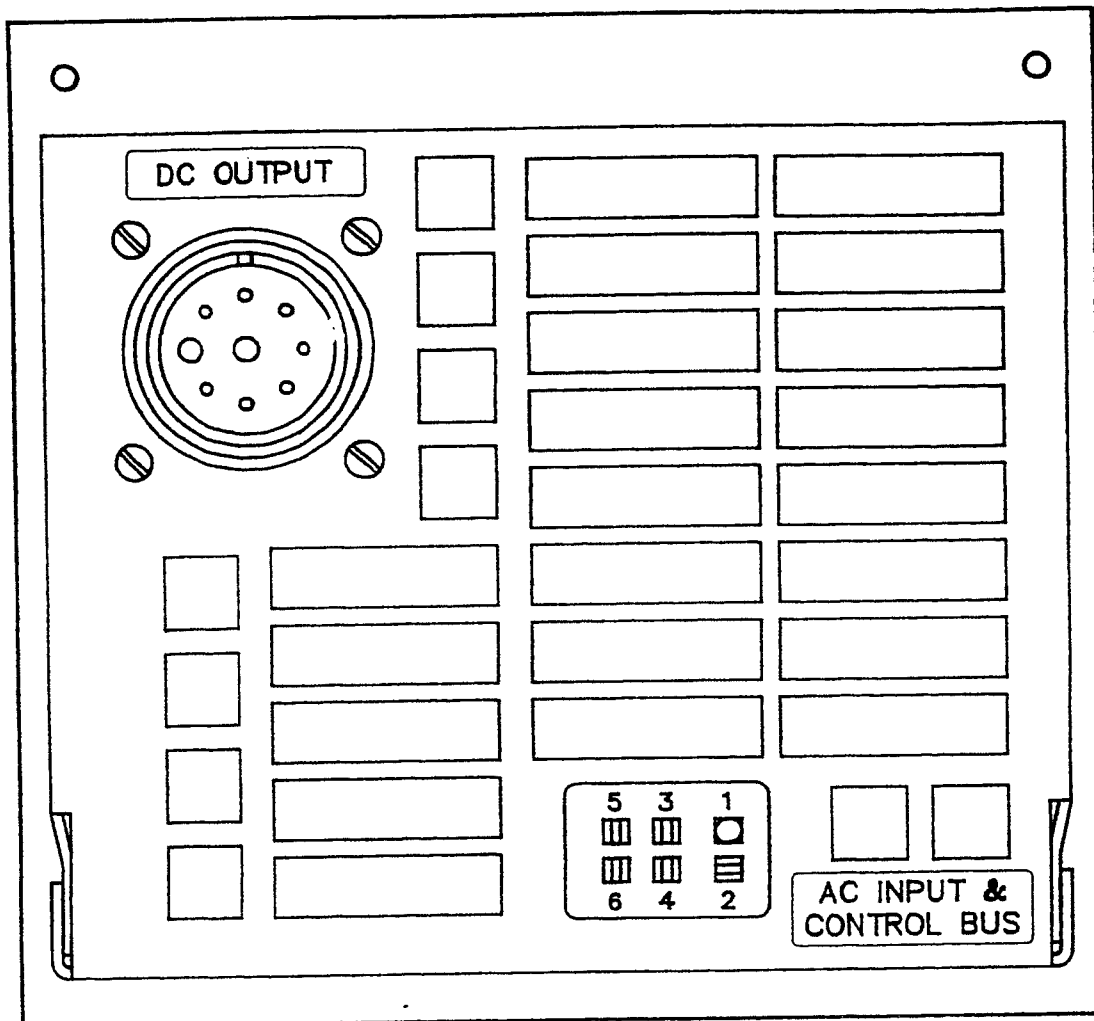

FIGURE 4 FRONT VIEW OF A 1/3 RACK SIZE MAT POWER MODULE



- PIN 1 = SIGNAL GROUND
- PIN 2 = HIGH
- PIN 3 = NEUTRAL
- PIN 4 = NOT USED
- PINS 5 AND 6 = CONTROL BUS

FIGURE 5 REAR VIEW OF A 1/3 RACK SIZE MAT POWER MODULE SHOWING THE DC OUTPUT CONNECTOR AND CONTROL BUS-AC INPUT CONNECTOR