

USER MANUAL

KLP SERIES

POWER SUPPLY

1200 WATT PROGRAMMABLE POWER SUPPLY

KEPCO INC.
An ISO 9001 Company.

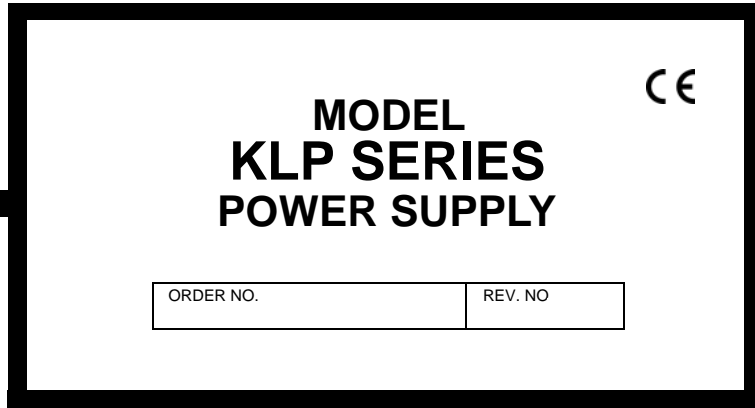

IMPORTANT NOTES:

- 1) This manual is valid for the following Firmware Versions:

FIRMWARE VERSION	NOTE.
10.07 and higher	
- 2) A Change Page may be included at the end of the manual. All applicable changes and revision number changes are documented with reference to the equipment serial numbers. Before using this Instruction Manual, check your equipment serial number to identify your model. If in doubt, contact your nearest Kepco Representative, or the Kepco Documentation Office in New York, (718) 461-7000, requesting the correct revision for your particular model and serial number.
- 3) The contents of this manual are protected by copyright. Reproduction of any part can be made only with the specific written permission of Kepco, Inc.

Data subject to change without notice.

©2023, KEPCO, INC
P/N 243-1248-r11



Conditions of Conformance

When this product is used in applications governed by the requirements of the EEC, the following restrictions and conditions apply:

1. For European applications, requiring compliance to the Low Voltage Directive, 2006/95/EC, this power supply is considered a component product, designed for "built in" applications. Because it is incomplete in construction, the end product enclosure must provide for compliance to any remaining electrical safety requirements and act as a fire enclosure. (EN 61010-1:2001, Cl. 6, Cl. 7, Cl.8, and Cl. 9)
2. This power supply is designed for stationary installation, with mains power applied via a detachable power supply cord or via direct wiring to the source power terminal block.
3. This power supply is considered a Class 1 (earthed) product. It is intended for use as part of equipment meant for test, measurement and laboratory use, and is designed to operate from single phase, three wire power systems. This equipment must be installed within a suitably wired equipment rack, utilizing a three wire (grounded) mains connection. See wiring section of this manual for complete electrical wiring instructions. (EN 61010-1:2001, Cl.6.10.1)
4. This power supply has secondary output circuits that are considered hazardous, and which exceed 240 VA at a potential of 2V or more.
5. The output wiring terminals of this power supply has not been evaluated for field wiring and, therefore, must be properly configured by the end product manufacturer prior to use.
6. This power supply employs a supplementary circuit protector in the form of a circuit breaker mounted on the front panel. This circuit breaker protects the power supply itself from damage in the event of a fault condition. For complete circuit protection of the end product, as well as the building wiring, it is required that a primary circuit protection device be fitted to the branch circuit wiring. (EN 61010-1:2001, Cl. 9.5)
7. Hazardous voltages are present within this power supply during normal operation. All operator adjustments to the product are made via externally accessible switches, controls and signal lines as specified within the product operating instructions. There are no user or operator serviceable parts within the product enclosure. Refer all servicing to qualified and trained Kepco service technicians.

SAFETY INSTRUCTIONS

1. Installation, Operation and Service Precautions

This product is designed for use in accordance with EN 61010-1 and UL 3101 for Installation Category 2, Pollution Degree 2. Hazardous voltages are present within this product during normal operation. The product should never be operated with the cover removed unless equivalent protection of the operator from accidental contact with hazardous internal voltages is provided:



There are no operator serviceable parts or adjustments within the product enclosure. Refer all servicing to trained service technician.



Source power must be removed from the product prior to performing any servicing.

2. Grounding

This product is a Class 1 device which utilizes protective earthing to ensure operator safety.



The PROTECTIVE EARTHING CONDUCTOR TERMINAL must be properly connected prior to application of source power to the product (see instructions on installation herein) in order to ensure safety from electric shock.



PROTECTIVE EARTHING CONDUCTOR TERMINAL - This symbol indicates the point on the product to which the protective earthing conductor must be attached.



EARTH (GROUND) TERMINAL - This symbol is used to indicate a point which is connected to the PROTECTIVE EARTHING TERMINAL. The component installer/assembler must ensure that this point is connected to the PROTECTIVE EARTHING TERMINAL.

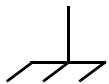

CHASSIS TERMINAL - This symbol indicates frame (chassis) connection, which is supplied as a point of convenience for performance purposes (see instructions on grounding herein). This is not to be confused with the protective earthing point, and may not be used in place of it.

3. Electric Shock Hazards

This product outputs hazardous voltage and energy levels as a function of normal operation. Operators must be trained in its use and exercise caution as well as common sense during use to prevent accidental shock.



This symbol appears adjacent to any external terminals at which hazardous voltage levels as high as 600V d-c may exist in the course of normal or single fault conditions.



This symbol appears adjacent to any external terminals at which hazardous voltage levels in excess of 600V d-c may exist in the course of normal or single fault conditions.

TABLE OF CONTENTS

SECTION	PAGE
SECTION 1 - INTRODUCTION	
1.1	Scope of Manual..... 1-1
1.2	General Description..... 1-1
1.3	Options..... 1-2
1.3.1	Rapid Output Discharge Circuit (RODC) Option (R Suffix)..... 1-2
1.4	Specifications..... 1-2
1.5	Features..... 1-10
1.5.1	Local Control..... 1-10
1.5.2	Remote Control..... 1-10
1.5.2.1	Digital Programming..... 1-10
1.5.2.2	Analog Programming..... 1-10
1.5.3	Digital Calibration..... 1-10
1.5.4	Overvoltage/Overcurrent Protection..... 1-11
1.5.5	User-defined Voltage/Current Limits (Virtual Models)..... 1-11
1.5.6	Storage of User-Programmed Active Settings..... 1-11
1.5.7	User-Programmed Sequences..... 1-11
1.5.8	Last Setting Recall..... 1-11
1.5.9	Built-in Protection..... 1-11
1.5.10	Internal Relay..... 1-12
1.5.11	Master/Slave Control [standard models Only]..... 1-12
1.6	Equipment Supplied..... 1-12
1.7	Accessories..... 1-13
1.8	Safety..... 1-14
SECTION 2 - INSTALLATION	
2.1	Unpacking and Inspection..... 2-1
2.2	Terminations and Controls..... 2-1
2.2.1	Front Panel Controls and Indicators..... 2-1
2.2.2	Rear Panel Connectors and Switches..... 2-2
2.3	Source Power Requirements..... 2-6
2.4	Cooling..... 2-6
2.5	Preliminary Operational Check..... 2-6
2.6	Installation..... 2-7
2.6.1	Rack Mounting..... 2-7
2.7	Wiring Instructions..... 2-7
2.7.1	Safety Grounding..... 2-8
2.7.2	Source Power..... 2-8
2.7.2.1	Current Rating..... 2-8
2.7.2.2	Connections..... 2-8
2.7.3	D-C Output Grounding..... 2-9
2.7.4	Power Supply/Load Interface..... 2-10
2.7.5	Load Connection - General..... 2-10
2.7.5.1	Local Sensing/Remote Sensing Select..... 2-10
2.7.6	Series Operation..... 2-11
2.7.7	Parallel Operation..... 2-11
2.7.7.1	Load Sharing..... 2-13
2.7.8	Master/Slave Configurations [Standard Models Only]..... 2-14
2.7.9	Analog I/O Connections..... 2-14
2.8	Digital Connections..... 2-15
2.8.1	GPIB Connections..... 2-15
2.8.2	RS 232 Connections [Standard Models Only]..... 2-15
2.8.3	LAN Connections [E-Series Models Only]..... 2-15
SECTION 3 - OPERATION	
3.1	General..... 3-1
3.2	Local Mode Operation..... 3-1
3.2.1	Turning the Power Supply On..... 3-1

TABLE OF CONTENTS

SECTION	PAGE
3.2.2	3-3
3.2.2.1	3-4
3.2.3	3-4
3.2.4	3-4
3.2.5	3-5
3.2.6	3-6
3.2.7	3-7
3.2.8	3-7
3.2.9	3-7
3.2.10	3-8
3.2.10.1	3-9
3.2.10.2	3-9
3.2.10.3	3-9
3.2.11	3-10
3.2.12	3-10
3.2.13	3-11
3.2.14	3-11
3.2.14.1	3-11
3.2.14.2	3-12
3.2.14.3	3-13
3.2.14.4	3-14
3.2.15	3-14
3.2.16	3-16
3.2.17	3-16
3.2.17.1	3-17
3.2.17.2	3-18
3.2.17.3	3-19
3.2.17.3.1	3-19
3.2.17.3.2	3-19
3.2.17.4	3-21
3.2.17.5	3-22
3.2.17.6	3-22
3.3	3-22
3.3.1	3-22
3.3.1.1	3-22
3.3.1.2	3-23
3.3.1.3	3-23
3.3.2	3-24
3.3.3	3-24
3.3.4	3-24
3.3.5	3-24
3.3.6	3-24
3.3.6.1	3-25
3.3.6.2	3-25
3.3.6.3	3-26
3.3.6.4	3-27
3.3.6.5	3-28
3.3.6.6	3-30
3.3.6.6.1	3-30
3.3.6.6.2	3-30
3.3.6.6.3	3-31
3.3.6.6.4	3-32

TABLE OF CONTENTS

SECTION	PAGE
3.3.6.6.5 Using a List (User-Programmed Sequences) [E-Series Models Only].....	3-32
3.3.6.6.6 Setting Virtual Model [E-Series Models Only]	3-34
3.4 Remote Programming Using Analog Signals	3-35
3.4.1 Programming with external resistance	3-36
3.4.2 Programming with external Voltage	3-37
3.4.3 Changing Overvoltage or Overcurrent Protection Values in Analog Programming Mode.....	3-38
SECTION 4 - CALIBRATION	
4.1 General	4-1
4.2 Equipment Required	4-1
4.3 Calibration Using Front Panel Controls in Local Mode	4-2
4.3.1 Voltage Calibration (Local)	4-3
4.3.2 Current Calibration (Local)	4-3
4.3.3 External Calibration (Local)	4-4
4.3.4 Calibration Exit (Local)	4-4
4.4 Calibration using VXI plug&play Driver.....	4-5
4.4.1 Voltage Calibration (VXI plug&play Driver Demo).....	4-6
4.4.2 Current Calibration (VXI plug&play Demo).....	4-7
4.4.3 Analog Reference Calibration (VXI plug&play Demo).....	4-9
4.4.4 Calibration Exit (VXI plug&play Demo).....	4-10
4.5 Changing the Calibration Password	4-10
4.6 Restoring Prior Calibration Values.....	4-11

KLP INSTALLATION/OPERATION SUMMARY

LIST OF FIGURES

FIGURE	TITLE	PAGE
1-1	KLP Series Power Supply	vi
1-2	KLP Operating Regions.....	1-3
1-3	KLP Series Power Supply, Mechanical Outline Drawing	1-8
2-1	KLP Series, Front Panel Controls and Indicators.....	2-1
2-2	KLP Series, Rear Panel Switch and Connectors	2-3
2-3	Remote Sensing.....	2-11
2-4	Series Connection using Remote Sensing.....	2-12
2-5	Parallel Connections Using Remote Sensing.....	2-12
3-1	Function Switch Menu Structure	3-5
3-2	Fault Recovery Configuration Display	3-21
3-3	PS Find Screen	3-26
3-4	Web Interface Home Page (Unit Description)	3-27
3-5	Web Interface Configure Instrument Page.....	3-28
3-6	Web Interface Configure LAN Page.....	3-29
3-7	Web Interface Operate Instrument Page	3-31
3-8	Protection Dialog Box.....	3-31
3-9	Save/Recall Dialog Box.....	3-31
3-10	Reset Dialog Box.....	3-32
3-11	List Dialog Box	3-33
3-12	Adding Multiple Steps (Ramps) to List	3-34
3-13	Virtual Model Dialog Box.....	3-35
3-14	Analog Programming of Output Voltage or Current using Resistance	3-36
3-15	Analog Programming of Output Voltage or Current using Voltage.....	3-37
4-1	Analog Port Wiring for Calibration	4-2
4-2	Calibration Window	4-6
4-3	Voltage Calibration Window	4-7
4-4	Current Calibration Window	4-8
4-5	Analog Reference Calibration Window.....	4-9

LIST OF TABLES

TABLE	TITLE	PAGE
1-1	Rapid Output Discharge Circuit Improvement in Output Response Time	1-2
1-2	Model Parameters	1-3
1-3	KLP Specifications	1-4
1-4	Equipment Supplied	1-12
1-5	Accessories	1-13
1-6	Safety Symbols	1-14
2-1	Controls, and Indicators	2-1
2-2	Analog I/O Switch Functions	2-2
2-3	IEEE 488 Port Connector (J4) Pin Assignments	2-4
2-4	RS 232 Port Connector (J3) Pin Assignments [Standard Models Only]	2-4
2-5	LAN Port Connector (J7) Pin Assignments [E-Series Models Only]	2-5
2-6	Control Input Terminal block Assignments	2-5
2-7	Analog I/O Connector (J2) Pin Assignments	2-5
2-8	Input Current Service Rating and Conductor Sizes	2-8
3-1	Power-up Built-in Test Error Codes	3-2
3-2	Fault Recovery Configuration	3-20
4-1	Factory Default Unit Passwords	4-10

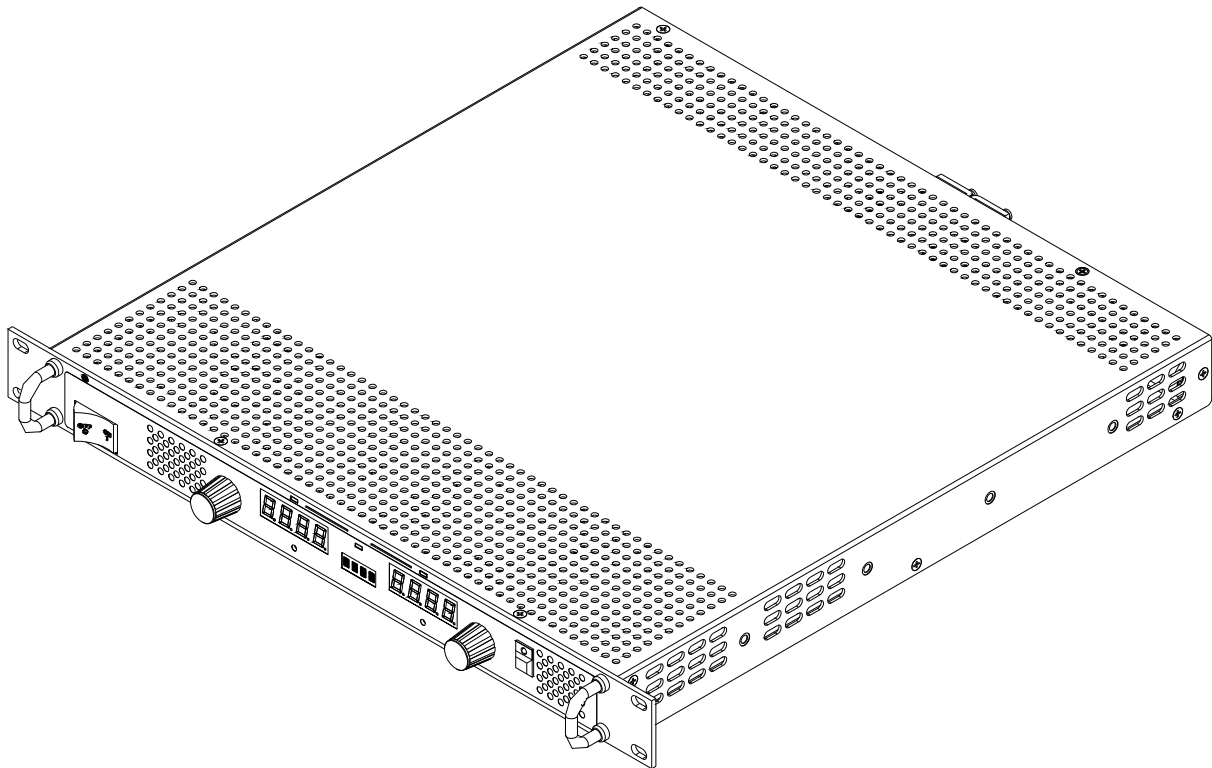

FIGURE 1-1. KLP SERIES POWER SUPPLY

SECTION 1 - INTRODUCTION

1.1 SCOPE OF MANUAL

This manual contains instructions for installation and operation of the KLP series of 1200W output power, stabilized voltage or current, d-c power supplies manufactured by KEPCO, Inc., Flushing, New York, U.S.A. Digital remote operation is described in the KLP Developer's Guide which can be downloaded from the Kepco website at www.kepcopower.com/support/opmanls.htm#klp.



WARNING

**DANGEROUS AND LETHAL POTENTIALS ARE PRESENT,
BOTH WITHIN THIS POWER SUPPLY, AND AT THE OUTPUT!**

Before proceeding to use the power supply, read this manual very carefully. Caution must be used when working with, and making connections to, this power supply. Use only wires with the proper voltage rating for high voltage connections.

1.2 GENERAL DESCRIPTION

The KLP Power Supply Series (Figure 1-1) are universal input, automatic crossover, 1200-watt constant power, voltage/current stabilizers with a full rectangular output characteristic within the voltage and current ranges listed in Table 1-2.

Seven standard (previously referred to as -1200) KLP Models and seven KLP E-Series Models (previously referred to as -1.2K) are available, as listed in Table 1-2. The standard Models are GPIB and RS 232 compatible; the KLP E-Series Models (identified by the E suffix) are GPIB and LAN (ethernet) compatible. The only difference between standard and E-Series models is that LAN replaces the RS 232 interface on E-Series models. All models allow remote analog programming as well as local control.

For each model a multitude of virtual models can be configured. The "rated voltage, maximum current at rated voltage" and "rated current and maximum voltage at rated current" parameters define the virtual models available within the limit of 1200 Watts of output power (see Figure 1-2).

KLP power supplies operate from wide range 90-265V a-c, 45-66 Hz input source power. Since there are no internal adjustments, KLP Power Supplies offer excellent output voltage/current stability and easy calibration.

Output voltage and current are displayed on independent LED displays. Control of the KLP can be either local, via the front panel controls and displays, or remote, using 1) either analog signals (applied to the Analog I/O Port), or 2) digital programming. Digital programming of standard models is via either IEEE 488.2 (GPIB) bus or RS 232 communication bus. The E-Series models offer digital programming via either IEEE 488.2 (GPIB) bus or using direct or web page control via the LAN port. Digital control is done with 12 bits of resolution over the entire voltage/current range.

The full-rack cross section permits mounting in a standard 19-inch wide rack (for optional chassis slides); see Table 1-5. Load connections are made at the rear panel. Sensing, monitor, and current share terminals are also available at the rear panel. Outline dimensions are provided in Figure 1-3.

1.3 OPTIONS

Options are identified by a letter suffix. Unless otherwise noted, options apply equally to standard and E-Series models, and specifications are not affected.

1.3.1 RAPID OUTPUT DISCHARGE CIRCUIT (RODC) OPTION (R SUFFIX)

The Rapid Output Discharge Circuit (RODC) option (suffix R) is available on all KLP models. This circuit rapidly discharges the output capacitance, thus significantly reducing response time to reductions in output voltage.

The circuit consists of a voltage detector that compares the programmed and actual values of output voltage. The discharge circuit is activated only when the actual voltage exceeds the programmed value.

Without the RODC circuit, discharge of the total output capacitance (internal and external) is achieved through a combination of the external load resistance and an internal current sink. For high load resistance or open circuit conditions at the output, response time (fall time) can vary from milliseconds to seconds depending upon the magnitude of the high-to-low voltage transition.

With the RODC option, output fall time is reduced to approximately the same value as rise time, even with external capacitance equal to 50% of the nominal internal output capacitance. Table 1-1 illustrates the typical performance improvement that can be expected with an open circuit output.

TABLE 1-1. RAPID OUTPUT DISCHARGE CIRCUIT IMPROVEMENT IN OUTPUT RESPONSE TIME

KLP Model No.	Nominal Internal Output Capacitance (C _O)	Test Voltage	Maximum Fall Time @ 1.5 x C _O	
			without RODC	with RODC ⁽¹⁾
KLP 10-150- ⁽²⁾	28600 µF	10V	600 msec	30 msec
KLP 20-120- ⁽²⁾	13000 µF	20V	675 msec	30 msec
KLP 36-60- ⁽²⁾	7280 µF	36V	1460 msec	30 msec
KLP 75-33- ⁽²⁾	5600 µF	75V	3690 msec	25 msec
KLP 150-16- ⁽²⁾	2200 µF	150V	8940 msec	30 msec
KLP 300-8- ⁽²⁾	550 µF	300V	8720 msec	26 msec
KLP 600-4- ⁽²⁾	118 µF	600V	6500 msec	33 msec

(1) Values shown assume that an external capacitance of 1/2 value of C_O is connected across the output terminals.
(2) Specifications listed apply to both standard and LAN models.

The RODC circuit will support continuous repetitive discharges from rated model voltage to zero at rate of up to 1 Hz for the 10V, 20V and 36V models, and up to 0.5 Hz for the 75V, 150V, 300V and 600V models. Smaller discharge steps will be supported at higher continuous rates; contact Kepco Applications Engineering for additional details. The RODC circuit employs protection against both peak energy and average power overload conditions by disabling only the RODC function until conditions recover to normal range; unit performance remains otherwise unaffected. Note that RODC Option units support the TRANSient command (see KLP Developer's Guide for details).

1.4 SPECIFICATIONS

Table 1-2 lists the parameters applicable to individual models. Table 1-3 lists general specifications applicable to all models except where otherwise noted.

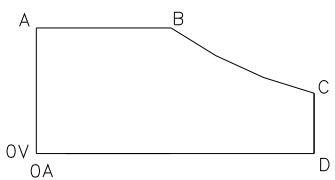
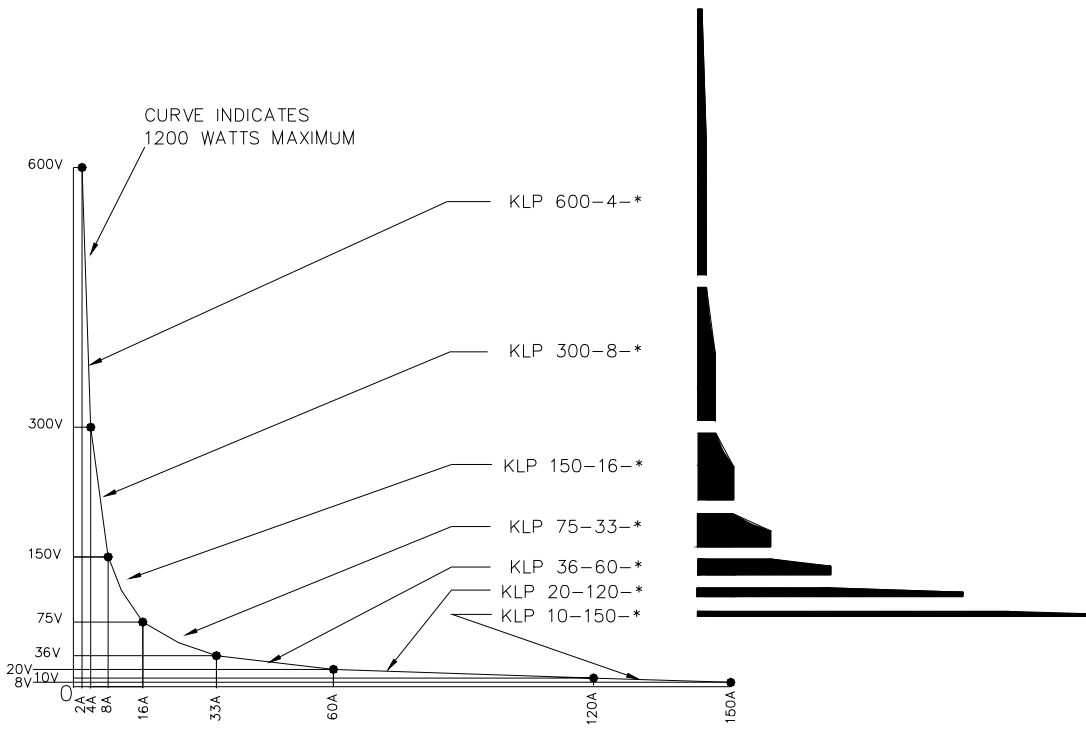

OPERATING REGION FOR EACH MODEL DEFINED BY POINTS A, B, C AND D. FROM POINT B TO POINT C, OPERATING REGION IS DEFINED BY 1200W MAXIMUM.

MODEL*	A	B	C	D
KLP 600-4	600V	2A	300V	4A
KLP 300-8	300V	4A	150V	8A
KLP 150-4	150V	8A	75V	16A
KLP 75-33	75V	16A	36V	33.3A
KLP 36-60	36V	33.3A	20V	60A
KLP 20-120	20V	60A	10V	120A
KLP 10-150	10V	120A	8V	150A

3042248

* SPECIFICATIONS APPLY TO ALL MODELS.

FIGURE 1-2. KLP OPERATING REGIONS

TABLE 1-2. MODEL PARAMETERS

Model number	Rated Voltage Range ⁽¹⁾	Maximum current for rated voltage	Minimum Programmable current	Rated Current Range ⁽¹⁾	Maximum voltage for rated current	Ripple and noise p-p ⁽²⁾	Efficiency @115 Va-c
KLP 10-150 ⁽³⁾	0-10V	120A@10V	1.9A	0-150A	8V@150A	60 mV	80%
KLP 20-120 ⁽³⁾	0-20V	60A@20V	1.5A	0-120A	10V@120A	60 mV	82%
KLP 36-60 ⁽³⁾	0-36V	33.3A@36V	0.8A	0-60A	20V@60A	60 mV	83%
KLP 75-33 ⁽³⁾	0-75V	16A@75V	0.4A	0-33.3A	36V@33.3A	60 mV	84%
KLP 150-16 ⁽³⁾	0-150V	8A@150V	0.2A	0-16A	75V@16A	125 mV	86%
KLP 300-8 ⁽³⁾	0-300V	4A@300V	0.1A	0-8A	150V@8A	150 mV	87%
KLP 600-4 ⁽³⁾	0-600V	2A@600V	0.05A	0-4A	300V@4A	150 mV	88%

(1) The maximum current and voltage are constrained by the 1200 watt power limitation, see Figure 1-2.
 (2) Bandwidth: 20MHz; low frequency ripple may be higher at loads less than 30 Watts.
 (3) Specifications listed apply to both standard and E-Series (suffix E) models.

TABLE 1-3. KLP SPECIFICATIONS

SPECIFICATION		RATING/DESCRIPTION	CONDITION/COMMENT
INPUT CHARACTERISTICS			
a-c voltage ⁽¹⁾	nominal	100-240 Va-c	Single Phase.
	range	90-265 Va-c	Wide Range; contact factory for operation to 265V a-c.
Frequency	nominal range	50-60 Hz	
	maximum	45-440 Hz	Increased Leakage above 66 Hz.
Power Factor	typical	0.99	Meets EN 61000-3-2.
Maximum Input Current	120 Va-c	13A rms	Rated load (1200W).
	240 Va-c	6.5A rms	Rated load (1200W).
Inrush Current	265 Va-c	40A	Peak
	132 Va-c	20A	Peak
Input Fusing		Circuit Breaker	2-line
Low a-c Protection		87V a-c, Self protected	
Output hold up	typical	10 milliseconds	Ride through.
Leakage Current	115 Va-c, 60Hz	1.2mA max	
	230 Va-c 50Hz	2.3mA max	
Electromagnetic compatibility	Emissions	CISPR11, Class A	Class B Conducted
	Immunity	EN 61326-1, Table 2	Industrial Environment
OUTPUT CHARACTERISTICS			
Type of stabilizer		CV/CC	Voltage/Current
Adjustment range	voltage	0-100% of rated voltage	No minimum load required.
	current	minimum to 100% of rated current	No minimum load required. See Table 1-2 for minimum programmable current.
Source effect	voltage	0.01% E _{max}	Over full source range.
	current	0.01% I _{max}	
Load effect	voltage	0.02% E _{max}	Over full load range.
	current	0.05% I _{max}	
Temperature effect	voltage	0.01%/deg C	0-50 deg C
	current	0.01%/deg C	
Time effect (drift)	voltage	0.02%/24hr	After 30 min warmup.
	current	0.02%/24hr	
Error sensing		0.25 volts per wire	Above rated output. Contact factory for larger margins.
Isolation voltage		600 Vd-c or peak (100V for 10V, 20V and 36V models)	Either output terminal to ground.
(1) Contact factory for details on operation from d-c input.			

TABLE 1-3. KLP SPECIFICATIONS (Continued)

SPECIFICATION		RATING/DESCRIPTION	CONDITION/COMMENT
OUTPUT CHARACTERISTICS - CONTINUED			
Transient recovery for load change	excursion	1% of E_{max}	50% load step 2A/microsecond max.
	recovery	2 msec	Return to 0.1% of setting.
Turnon/turnoff overshoot		2%	Rated output, any load
Rise Time	Voltage	10V, 20V, 36V: 30 msec, 75V: 40 msec, 150V: 50 msec, 300V: 60 msec, 600V: 75 msec	0 - E_{max} , rated load (resistive)
	Current	10V, 20V, 36V: 30 msec, 75V: 40 msec, 150V: 50 msec, 300V: 60 msec, 600V: 75 msec	0 - I_{max} , rated load (resistive)
Fall Time	Voltage no load	10V: 475 msec, 20V: 525 msec, 36V: 825 msec, 75V: 2820 msec, 150V: 4850 msec, 300V: 4400 msec, 600V: 3150 msec,	E_{max} - 0, no load (open circuit). NOTE: For improved performance, see RODC option (PAR. 1.3.1).
	Voltage rated load	10V, 20V, 36V: 30 msec, 75V: 40 msec, 150V: 50 msec, 300V: 60 msec, 600V: 75 msec	E_{max} - 0, rated load (resistive)
	Current	10V, 20V, 36V: 30 msec, 75V: 40 msec, 150V: 50 msec, 300V: 60 msec, 600V: 75 msec	I_{max} - 0, rated load (resistive)
Overvoltage protection	voltage	20-120% of E_{max}	Programmable; see PAR. 3.2.11. Selectable Recovery Mode (see PAR. 3.2.17.3.2)
Overcurrent protection	current	72-120% of I_{max}	
Output Load wire protection		Shutdown	Selectable Recovery Mode (see PAR. 3.2.17.3.2)
Parallel operation		Active load sharing within 5% of I_o rated	Up to 5 units, maximum.
GENERAL (ENVIRONMENTAL) SPECIFICATIONS			
Temperature	operating	-10 to +50°C	Rated load.
		+50°C to +70°C	Derate current 3% per °C from 50°C to 70°C.
	storage	-40°C to +85°C	
Overtemperature protection		Shutdown	See PAR. 3.2.17.3.2.
Cooling		3 internal d-c fans	exhaust to the rear
Humidity		0 to 95% RH	non-condensing
Shock		20g, 11msec +/- 50% half sine	non-operating
Vibration	5 -10 Hz	10mm double amplitude	3-axes, non-operating
	10-55 Hz	2g	3-axes, non-operating
Altitude		sea level to 10000 ft.	0-3,000 ft: 100%, linear derating to 70% of power at 10,000ft.
Loss of source power protection		Shutdown	Selectable Recovery Mode (see PAR. 3.2.17.3.2).
Overtemperature protection		Shutdown	
Fan failure protection		Shutdown	

TABLE 1-3. KLP SPECIFICATIONS (Continued)

SPECIFICATION		RATING/DESCRIPTION	CONDITION/COMMENT
PHYSICAL CHARACTERISTICS			
Dimensions	English	1.735"H x 19"W x 17.5"D	Depth excluding connectors and terminal blocks (see Figure 1-3).
	metric	44.45 x 482.6 x 443.7 mm	
Weight	English	15 lbs	
	metric	6.82kg	
Dielectric strength	Input - Chassis	2121V d-c	
	Output - Chassis	2121V d-c (1250V d-c 10V, 20V, and 36V models)	
	Input - Output	4242V d-c (2500V d-c 10V, 20V, and 36V models)	
Source power connector		IEC 320-C19 appliance inlet	250 Va-c, 16A (VDE); 125V a-c, 20A (UL)
Load connections	10-36V models	Nickel plated copper busbar with integral threaded stud (1/4-20-1/2in.)	Provision for safety covers.
	75-600V models	Shock-safe Euroblock, single conductor size: 20-10AWG (0,5 - 5,0 mm ²)	
Analog programming port.		15 pin D-sub	
Digital programming ports	primary	Standard GPIB connector	IEEE 488.2 (GPIB)
	secondary	9 pin D-sub	RS 232 (standard Models only)
	secondary	RJ 45	LAN (E-Series Models Only)
Feedback/Control Input		5 position low profile Euroblocks	
PROGRAMMING CHARACTERISTICS - LOCAL			
Local control		rotary encoders	Panel mounted.
Local control resolution	Coarse	~100 LSB/step	Depress control for Fine resolution
	Fine	1 LSB/step	
Setting range		0-100% of rating	KLP will automatically adjust limit to maintain 1200 W maximum,
Power up settings	voltage	defaults to zero	See PAR. 3.2.10.3 for Last Settings Recall function.
	current	defaults to min. value (See Table 1-2)	
Protection Limits	Overvoltage	20-120% of Emax	Programmable; accessed via front panel protect switch or SCPI command over digital bus.
	Overcurrent	72-120% of Imax	

TABLE 1-3. KLP SPECIFICATIONS (Continued)

SPECIFICATION		RATING/DESCRIPTION	CONDITION/COMMENT
PROGRAMMING CHARACTERISTICS - ANALOG			
Analog remote control	selection	Activate with jumper at analog programming connector	Recognized during power up.
	isolation	Safety Extra Low Voltage (SELV)	
Analog Input Update Rate		2Hz (0.5 Second) Applies to programming by voltage/ resistance and read-back specifications.	Analog input voltage digitized (12-bit resolution), optically isolated, then processed by digital section.
Programming by voltage	voltage	0-10V	See PAR. 4.3.3 to reduce Full Scale voltage.
	current	0-10V	Min. programming limit; see Table 1-2. See PAR. 4.3.3 to reduce Full Scale voltage.
Programming by resistance	voltage	0-10K ohms	See PAR. 4.3.3 to reduce Full Scale resistance.
	current	0-10K ohms	Min. programming limit; see Table 1-2. See PAR. 4.3.3 to reduce Full Scale resistance.
Readback		0-10V proportional signal	Proportional to analog control voltage/resistance.
Remote inhibit		TTL compatible	Dual polarity; see PAR. 3.2.17.3.1.
Composite status flag		Isolated form C contacts	Programmable functions (PAR. 3.2.17.1).
PROGRAMMING CHARACTERISTICS - DIGITAL			
Supported Interfaces	standard models	GPIB and RS 232	SCPI command set for GPIB and RS 232 (see KLP Developer's Guide).
	E-Series models	GPIB and LAN	Support SCPI command set (see KLP Developer's Guide) for GPIB and LAN; Support four interfaces for LAN: 1. Web interface, port 80 2. SCPI Telnet, port 5024 3. SCPI Sockets, port 5025 4. VXI 11, port 1024
GPIB		GPIB address range: 1 to 30	Factory default is 6.
RS 232	standard models	Baud Rate range: 2400, 4800, 9600, 19,200 or 38,400	Factory default is 38,400.
Digital remote control	isolation	Safety Extra Low Voltage (SELV)	
	format	compatible with SCPI protocols	W98 SE and later operating systems.
Programming resolution		0.024% of Emax and Imax	
Programming accuracy		0.05% of Emax and Imax	
Readback resolution		0.024% of Emax and Imax	
Readback accuracy		Either 0.1% of Emax and Imax, or front panel voltmeter or ammeter display resolution, whichever is greater. ⁽¹⁾	±1 LSB error
Status reporting		OVP, OCP, OTP, output lead fault (OLF), fan failure, power loss	See PAR. 1.5.4 and 1.5.9.

(1) Display resolution is determined by the number of significant digits shown, relative to the decimal point. Resolution is 10^{-X} where X is the number of digits to the right of the decimal point. E.g for display of 10.00V, resolution is 10^{-2} or 0.01 or 10mV; for display of 150.0A, resolution is 10^{-1} or 0.1 or 100mA.

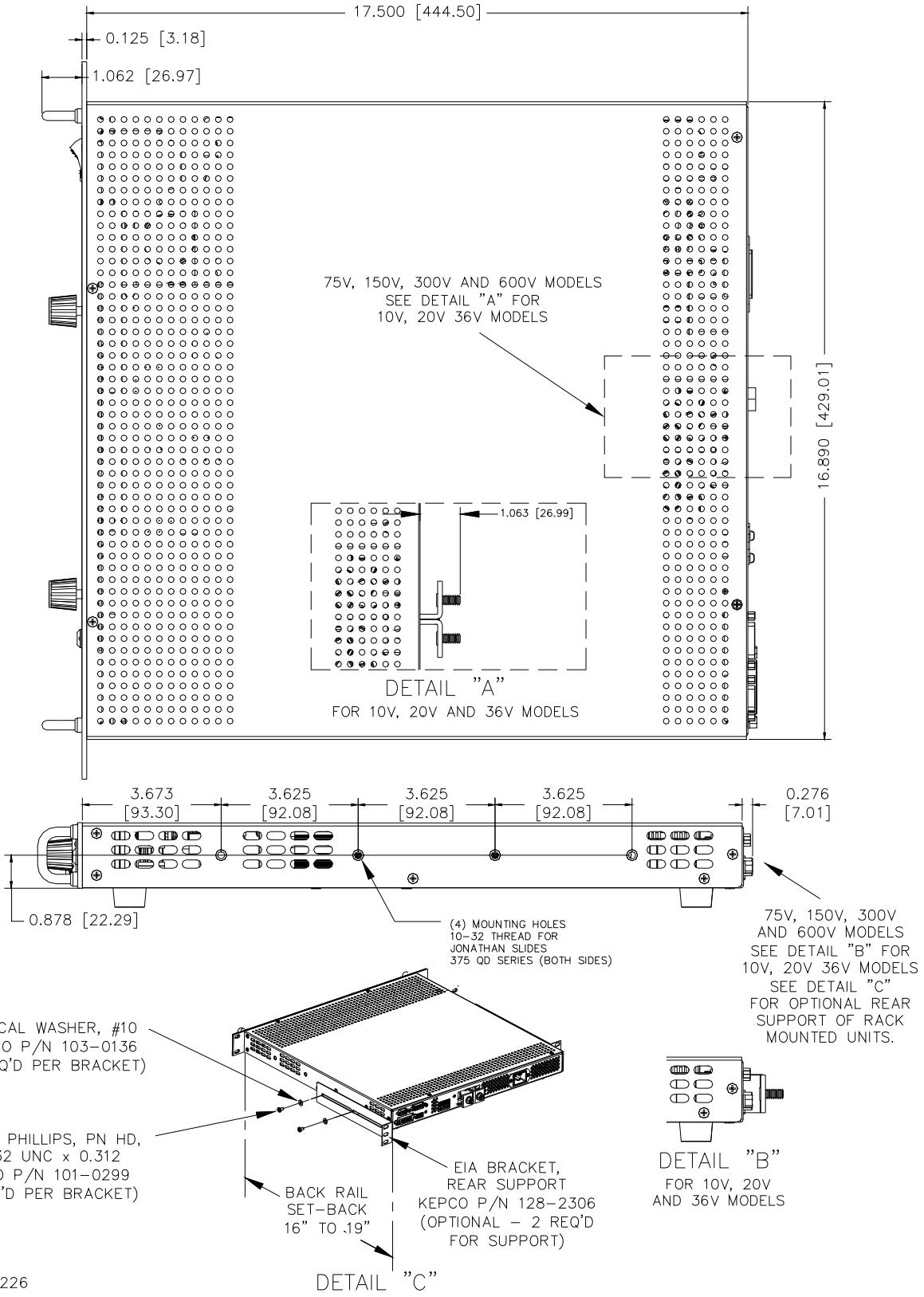
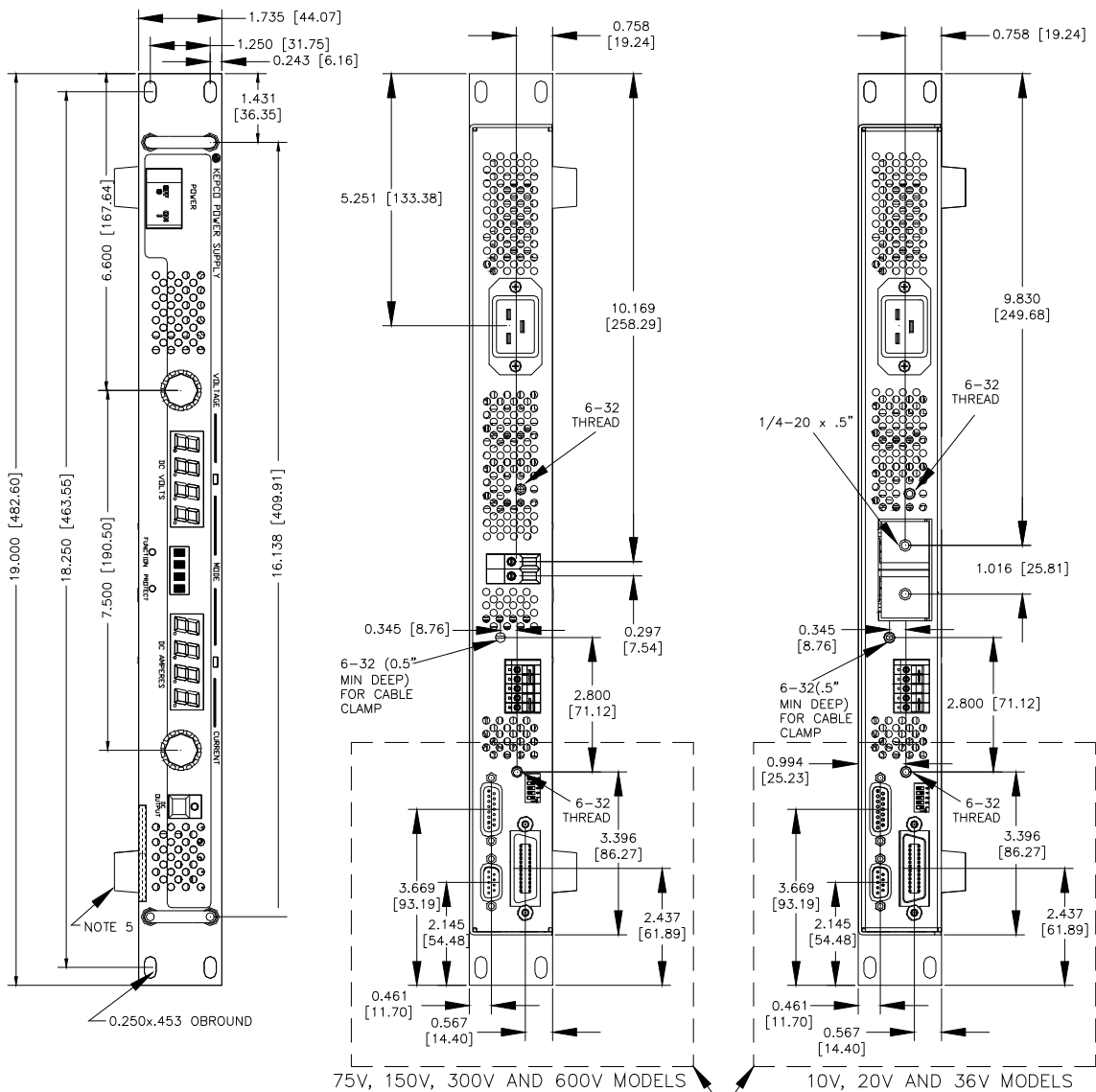
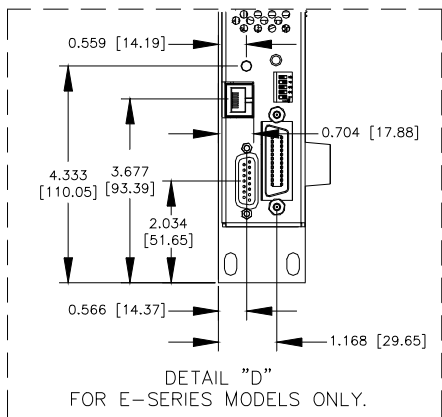

FIGURE 1-3. KLP SERIES POWER SUPPLY, MECHANICAL OUTLINE DRAWING (SHEET 1 OF 2)



- NOTES:
- MATERIAL:
 - CHASSIS: 0.064 THK. ALUM. 5052-H32
 - COVER: 0.064 THK. ALUM. 5052-H32
 - FRONT PANEL: 0.125 THK. ALUM. 6061-T6
 - FINISH:
 - CHASSIS, COVER AND BACKPLATE: YELLOW IRIDITE
 - FRONT PANEL: KEPKO GREY
 - DIMENSIONS IN PARENTHESES ARE IN MILLIMETERS.
 - TOLERANCES:
 - BETWEEN MOUNTING HOLES: $\pm 1/64$ (± 0.4).
 - ALL OTHER DIMENSIONS: $\pm 1/32$ (± 0.8) EXCEPT AS NOTED.
 - REMOVE 4 PLASTIC FEET BEFORE RACK INSTALLATION
 CAUTION: IF REINSTALLATION OF FEET IS NECESSARY, FAILURE TO REINSTALL FEET USING ALL HARDWARE SPECIFIED OR LONGER SCREW CAN RESULT IN DAMAGE TO THE UNIT.
 SCREW: 6-32 X 0.50 IN. (MAX), BHPH (P/N 101-0019)
 LOCKWASHER, #6, 0.018 IN. THK (P/N 103-0015)
 FLAT WASHER, #6, 0.028 IN. THK (P/N 103-0100)



3043459-B

FIGURE 1-3. KLP SERIES POWER SUPPLY, MECHANICAL OUTLINE DRAWING (SHEET 2 OF 2)

1.5 FEATURES

1.5.1 LOCAL CONTROL

Two front panel rotary encoders allow adjustment of voltage and current setpoints and limits. Operating mode of the power supply is indicated by lighting either a green (Constant Voltage) or amber (Constant Current) LED. The output can be enabled or disabled by the front panel DC OUTPUT switch; an associated indicator lights when the output is enabled (applied to the load). Two 4-character LEDs normally display actual output voltage and current, or programmed voltage and current limits in setpoint mode.

The voltage and current controls and their associated LED displays are also used with the FUNCTION and PROTECT switches and the 4-character status display for various other functions described in PAR. 3.2. A local lockout feature (see PAR. 3.2.2.1) prevents alteration of the power supply settings from the front panel when the power supply is operating in remote mode.

1.5.2 REMOTE CONTROL

Remote control of the KLP Power Supply can be accomplished either through digital or analog programming.

1.5.2.1 DIGITAL PROGRAMMING

Digital control for standard models is available directly via either the IEEE 488.2 (GPIB) or RS 232 ports using SCPI commands. Digital control for E-Series models is available directly via either the IEEE 488.2 (GPIB) port using SCPI commands or via the LAN port using SCPI commands or web pages. Most features available in local mode can be accessed in remote mode through digital programming, as well as some that are only available via digital remote programming (PAR. 3.3.2). Front panel indicators showing operating mode and output voltage and current are active when digital programming is used. Refer to the KLP Developer's Guide for more information about digital programming.

1.5.2.2 ANALOG PROGRAMMING

KLP Power Supplies can also be controlled remotely using switch selectable voltage or resistance. Analog programming functions include voltage and current programming, enabling/disabling the output, and voltage and current readback (see PAR. 3.4).

Full scale programming/readback can be programmed using either an input analog voltage or by an input analog resistance. See PAR. 3.4 for more information.

1.5.3 DIGITAL CALIBRATION

Internal adjustments of the KLP Power Supply are automatic. Calibration can be performed in either local or remote (using the VXi *plug&play* demo program) digital mode, using a calibrated DVM and a corresponding precision shunt resistor.

Calibration constants for programming and read-back activities are calculated by the microcontroller and stored in the non-volatile memory. No internal adjustments are necessary. The previous calibration is saved and can be restored if desired. The original factory calibration can also be restored. Calibration is password-protected. Refer to Section 4 for more information.

1.5.4 OVERVOLTAGE/OVERCURRENT PROTECTION

Overvoltage and Overcurrent protection values can be individually programmed. If the output voltage/current exceeds the overvoltage/overcurrent protection value, the protection circuit latches the output off, flashes an overvoltage (OVP) or overcurrent (OCP) error message on the status display and sets a status bit that can be retrieved through the RS 232 [standard models only], LAN [E-Series models only], or GPIB port. The N.O. and N.C. contacts of the relay provide status flags via the Analog I/O port connector. Refer to PAR. 3.2.17.1 for more information.

1.5.5 USER-DEFINED VOLTAGE/CURRENT LIMITS (VIRTUAL MODELS)

The KLP Power Supply can be programmed to User-defined values that can be lower than the maximum values. For example, the KLP 36-60 will automatically be limited to 1200 Watts as illustrated in Figure 1-2, however arbitrary limits, e.g., 40A@30V or 30A@35V can be established. Once the limits are set, setting values exceeding the limit values will not be accepted. Refer to PAR. 3.2.9 for more information.

1.5.6 STORAGE OF USER-PROGRAMMED ACTIVE SETTINGS

The KLP Power Supply contains 40 memory locations that can be used to store active settings. This feature is only available via digital remote programming. Values are stored in the nonvolatile memory, and are retained when the unit is turned off (refer to PAR 3.3.2 for more information).

1.5.7 USER-PROGRAMMED SEQUENCES

The KLP Power Supply contains 100 memory locations for programming sequences that can program the KLP to produce a variety of sequential output operations. Each memory location accommodates a value for voltage and current and a dwell time (how long the parameter is to be in effect). Values are stored in the volatile memory, and are lost when the unit is turned off (refer to PAR 3.3.2 for more information).

1.5.8 LAST SETTING RECALL

The KLP Power supply has the ability to retain the last voltage and current setpoints programmed before the unit is shut off. A DIP switch selection (position 3) allows the user to determine whether the power supply is set to 0V, minimum current or the retained voltage and current setpoints upon the next power-up sequence. Refer to Table 2-2 and PAR. 3.2.10.3 for more information.

1.5.9 BUILT-IN PROTECTION

KLP Series Power Supplies provide built-in protection against the system faults listed below. In each case, a detected fault results in immediate latched shutdown of the power supply output. In addition, the status display flashes the appropriate indication and the status bit is set for retrieval through either of the digital programming ports. If the internal relay is configured for FAULT mode (factory default setting, see PAR. 3.2.17.1) the relay will toggle to provide a composite fault indication at the analog programming port. The indication time is limited by internal hold-up capacity for PWR faults (as the unit shuts down, when power is no longer sufficient to power the relay it de-energizes).

- a. **Overtemperature (OTP).** Monitors heatsink temperature; trips if it exceeds factory set limit.
- b. **Overvoltage (OVP) or overcurrent (OCP) at the output.** (See PAR. 3.2.11)

- c. **Fan failure (FAN).** Monitors all three internal cooling fans; trips if failure of any fan.
- d. **Output Lead Fault (OLF).** Monitors output power and sense leads; trips if any discontinuity (open circuit) is detected in load connections.
- e. **Source Power Loss (PWR).** Monitors internal d-c bus voltage at output of PFC; trips if low a-c input or PFC failure occurs.

1.5.10 INTERNAL RELAY

An internal relay provides common, normally open and normally closed contacts available to the user via the analog I/O connector. This relay is normally programmed (factory default) to energize upon detection of a system fault (FLT mode); see PAR. 1.5.9 for a list of faults. The relay may also be programmed to be energized at the user's discretion from the front panel (MAN mode), or as part of a user-specified program using LIST commands (LIST mode). Refer to PAR. 3.2.17.1 for details.)

1.5.11 MASTER/SLAVE CONTROL [STANDARD MODELS ONLY]

For applications that require the use of multiple standard KLP power supplies in either series (for higher voltage) or parallel (for redundancy or higher current) the master/slave feature allows a single power supply (the master) to automatically control both outputs to achieve the desired output. Refer to PAR. 2.7.8 and 3.2.14 for details.

1.6 EQUIPMENT SUPPLIED

Equipment supplied with the unit is listed in Table 1-4.

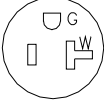
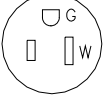
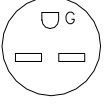
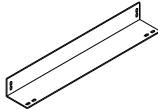

TABLE 1-4. EQUIPMENT SUPPLIED

ITEM	PART NUMBER	QUANTITY
Jumper (24 AWG or larger bus wire) for local sensing connections	172-0585	2
Analog I/O port mating connector	142-0528	1
Source power mating connector. Mates with a-c source power input connector J1 (see Figure 2-2). Allows user to fabricate custom line cord. Prefabricated line cords available as accessories (see Table 1-5).	142-0381	1
Quick Start Guide	228-1773	1
Nut, 1/4-20, with captive lockwasher (on output studs of 10V, 20V and 36V models only)	102-0175	2

1.7 ACCESSORIES

Accessories for the KLP Power Supply are listed in Table 1-5.



TABLE 1-5. ACCESSORIES

ITEM	FUNCTION		KEPCO PART NUMBER
Line Cord Set (125V/20A)	2.5m long cord set, provides for source power connection. Mates with NEMA 5-20R receptacle (see adjacent figure). Supports rated load power over mains voltage range of 100-136V a-c.	NEMA 5-20R 	118-0776
Line Cord Set (125V/15A)	2.5m long cord set, provides for source power connection. Mates with NEMA 5-15R receptacle (see adjacent figure). Supports restricted load power over mains voltage range of 100-136V a-c (contact Kepco Sales Engineering for details).	NEMA 5-15R 	118-1136
Line Cord Set (250V/15A)	2.5m long cord set, provides for source power connection. Mates with NEMA 6-15R receptacle (see adjacent figure). Supports rated load power over mains voltage range of 180-265V a-c.	NEMA 6-15R 	118-1137
IEEE 488 (GPIB) Cable, 1m long	Connect KLP Power Supply to GPIB bus.		SNC 488-1
IEEE 488 (GPIB) Cable, 2m long	Connect KLP Power Supply to GPIB bus.		SNC 488-2
IEEE 488 (GPIB) Cable, 4m long	Connect KLP Power Supply to GPIB bus.		SNC 488-4
Chassis Slide (2 required per power supply)	Allows rack-mounted units to slide in and out.		108-0239 (Jonathan 375-QD Series)
Analog Connector Backshell	Locks analog port mating connector to KLP via jackscrews.		108-0204
Loop Back Test Connector	Used for verification of RS 232 operation.		195-0112
Null Modem Cable, 10 ft.	Connect RS 232 port with controlling computer, DB9F to DB9F, 10 feet long.		118-1176
Null Modem Cable, 1 ft.	Used for Master/Slave connections. Connects RS 232 ports of stacked power supplies, DB9F to DB9F, one foot long.		118-1220
LAN Patch cable	Connects KLP LAN port to LAN, 10 ft long.		118-1115
Support bracket, rear	Provides extra support to rear of rack-mounted unit if needed. Two brackets required per unit. Each bracket requires 2 screws and 2 washers. See Figure 1-3, sheet 1, Detail "D" for requirements.		128-2306
Side Support "L" Bracket	L bracket mounts to vertical rails to provide additional side support for rack-mounted models. 19.6 in. long x 2.3 in. high x 3.5 in. wide. Two (2) required per unit.		128-1775
Connector, DB15 to Euroblock	Allows convenient access to I/O connector pins.		142-0636
Safety Cover Kit	Kit includes cover with mounting hardware to prevent contact with KLP output terminals		KIT 219-0545

1.8 SAFETY

There are no operator serviceable parts inside the case. Service must be referred to authorized personnel. Using the power supply in a manner not specified by Kepco, Inc. may impair the protection provided by the power supply. Observe all safety precautions noted throughout this manual. Table 1-6 lists symbols used on the power supply or in this manual where applicable.

TABLE 1-6. SAFETY SYMBOLS

SYMBOL	MEANING
	CAUTION: RISK OF ELECTRIC SHOCK.
	CAUTION: REFER TO REFERENCED PROCEDURE.
WARNING	INDICATES THE POSSIBILITY OF BODILY INJURY OR DEATH.
CAUTION	INDICATES THE POSSIBILITY OF EQUIPMENT DAMAGE.

SECTION 2 - INSTALLATION

2.1 UNPACKING AND INSPECTION

This instrument has been thoroughly inspected and tested prior to packing and is ready for operation. After careful unpacking, inspect for shipping damage before attempting to operate. Perform the preliminary operational check as outlined in PAR 2.5. If any indication of damage is found, file an immediate claim with the responsible transport service.

2.2 TERMINATIONS AND CONTROLS

2.2.1 FRONT PANEL CONTROLS AND INDICATORS. Refer to Figure 2-1 and Table 2-1.

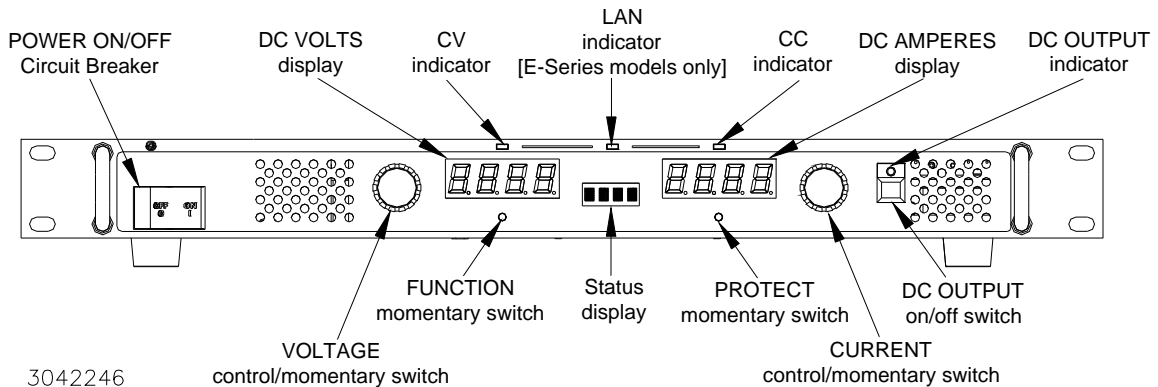

FIGURE 2-1. KLP SERIES, FRONT PANEL CONTROLS AND INDICATORS

TABLE 2-1. CONTROLS, AND INDICATORS

CONTROL OR INDICATOR	FUNCTION
POWER ON/OFF Circuit Breaker	Turns the power supply on or off. Applies input power to power supply internal circuits. Circuit breaker provides input overload protection.
VOLTAGE control/switch	Multifunction rotary encoder with momentary-contact pushbutton switch. Rotate to set output voltage (PAR. 3.2.10) and overvoltage limit (PAR. 3.2.11). Also used to enter SET mode of voltage programming (PAR. 3.2.10.2), change GPIB address (PAR. 3.2.12), change RS 232 baud rate (PAR. 3.2.13), and enter calibration password and perform calibration (PAR. 4.3).
DC VOLTS display	Four-digit LED display that shows voltage settings: a. Shows actual output voltage (default). b. Shows voltage set point (PAR. 3.2.10.2) or overvoltage limit when function selected (PAR. 3.2.11).
CV indicator	Green LED lights to indicate power supply is operating in constant voltage mode (see PAR. 3.2.10).
Status 4 character display	Displays active function or blinks for error messages. Normally blank (VOLTAGE and CURRENT LEDs display actual voltage and current).
CC indicator	Amber LED lights to indicate power supply is operating in constant current mode (see PAR. 3.2.10).

TABLE 2-1. CONTROLS, AND INDICATORS (CONTINUED)

CONTROL OR INDICATOR	FUNCTION
DC AMPERES display	Four-digit LED display that shows current settings: a. Shows actual output current (PAR.3.2.10). b. Shows current set point or overcurrent limit when function selected (PAR. 3.2.10.2). c. Shows GPIB address (PAR. 3.2.12), baud rate (PAR. 3.2.13). d. Shows unit password (PAR. 3.2.9 and PAR. 4.3).
CURRENT control/ momentary switch	Multifunction rotary encoder with momentary-contact pushbutton switch. Rotate to set output current (PAR. 3.2.10) and overcurrent limit (PAR. 3.2.11). Also used to enter SET mode of current programming (PAR. 3.2.10.2), change GPIB address (PAR. 3.2.12), change RS 232 baud rate (PAR. 3.2.13), enter Virtual Model password (PAR. 3.2.9), and enter calibration password and perform calibration (PAR. 4.3).
DC OUTPUT indicator	Green LED lights when DC output is enabled. LED is off when output is disabled.
DC OUTPUT on/off switch	Enables or disables the DC Output. When output is disabled, current and voltage are programmed to minimal value and zero, respectively (PAR. 3.2.5). Also used to accept front panel inputs.
PROTECT momentary switch	Used to set overvoltage and overcurrent (PAR. 3.2.11) protection limits. NOTE: Requires a thin tool (e.g., end of paper clip) to press switch.
LAN Indicator [E-Series models only]	Green LED indicates when LAN interface is installed and valid IP address found. Can be intentionally blinked using the web-based interface to identify which unit is being accessed in a multi-unit environment. During initialization the LED blinks rapidly while attempting to locate a valid IP address. If successful, LED stays on without blinking; LED not lit indicates failure.
FUNCTION momentary switch	Used to set user-determined limits on voltage and current (virtual model) (PAR. 3.2.9), view KLP configuration (Firmware Version, Model rating, Options installed) (PAR. 3.2.16), change GPIB address (PAR. 3.2.12), change RS 232 baud rate (standard models only, PAR. 3.2.13), set up master/slave operation (standard models only, PAR. 3.2.14), set up LAN interface (E-Series models only, PAR. 3.2.15), and enter the Utility menu (PAR. 3.2.17). The utility menu is used to configure the internal relay (PAR. 3.2.17.1), configure quick-boot (PAR. 3.2.17.2), configure Remote Inhibit (high or low) and determine how the unit responds to faults (PAR. 3.2.17.3), calibrate analog inputs (PAR. 3.2.17.4), and enter calibration (PAR. 4.3). NOTE: Requires a thin tool (e.g., end of paper clip) to press switch.

2.2.2 REAR PANEL CONNECTORS AND SWITCHES. Refer to Figure 2-2 and Tables 2-2 through 2-7.

TABLE 2-2. ANALOG I/O SWITCH FUNCTIONS

DIP SWITCH POSITION	FUNCTION	SETTINGS
1	Allows analog programming commands for voltage to be provided by either variable voltage (PAR. 3.4.2) or resistance (PAR. 3.4.1).	ON: Selects Resistance OFF: Selects Voltage (factory default)
2	Allows analog programming commands for current to be provided by either variable voltage (PAR. 3.4.2) or resistance (PAR. 3.4.1).	ON: Selects Resistance OFF: Selects Voltage (factory default)
3	Allows retention of the last entered setpoint values for voltage and current in non-volatile memory for recall at the next power-up sequence. (see PAR. 3.2.10.3).	ON: Save and recall previous setpoint values upon power-up. OFF: Power-up set to 0 Volts and minimum current (factory default).
4	Reserved - Do not use.	
5	Allows locking of the front panel controls. (see PAR. 3.2.2.1)	ON: Local controls locked. OFF: Local controls enabled (factory default).

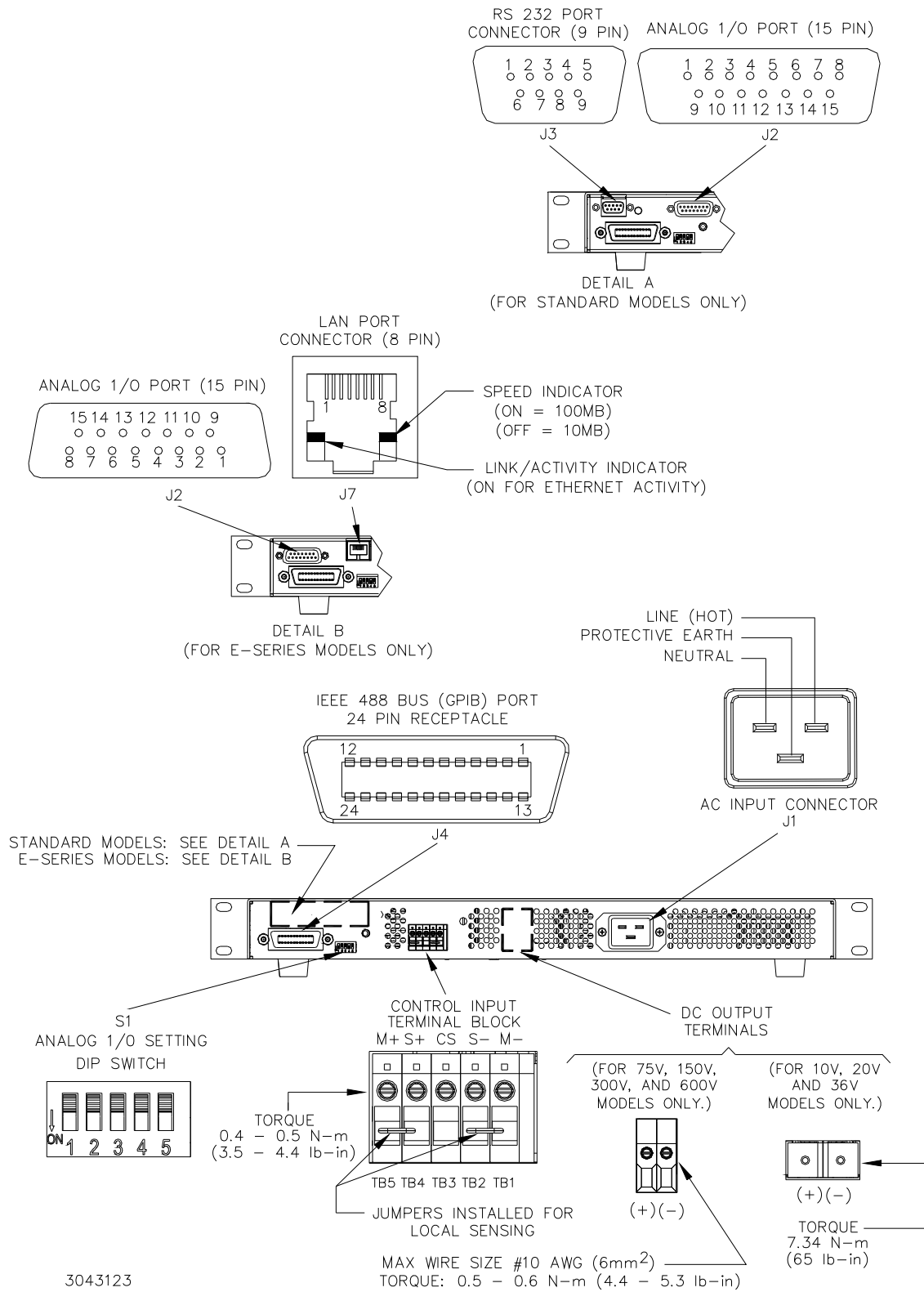

FIGURE 2-2. KLP SERIES, REAR PANEL SWITCH AND CONNECTORS

TABLE 2-3. IEEE 488 PORT CONNECTOR (J4) PIN ASSIGNMENTS

PIN	SIGNAL NAME	FUNCTION
1	DI01	I/O Line
2	DI02	I/O Line
3	DI03	I/O Line
4	DI04	I/O Line
5	EOI	End or Identify
6	DAV	Data Valid
7	NRFD	Not Ready for Data
8	NDAC	Not Data Accepted
9	IFC	Interface Clear
10	SRQ	Service Request
11	ATN	Attention
12	SHIELD	Shield
13	DI05	I/O Line
14	DI06	I/O Line
15	DI07	I/O Line
16	DI08	I/O Line
17	REN	Remote Enable
18	GND	Ground (signal common)
19	GND	Ground (signal common)
20	GND	Ground (signal common)
21	GND	Ground (signal common)
22	GND	Ground (signal common)
23	GND	Ground (signal common)
24	LOGIC GND	Logic Ground

TABLE 2-4. RS 232 PORT CONNECTOR (J3) PIN ASSIGNMENTS [STANDARD MODELS ONLY]

PIN	SIGNAL NAME	FUNCTION
NOTE: A null modem cable (see Table 1-5) is required for nearly all applications, with the exception of those in which RXD and TXD line transposition is accomplished via external hardware (e.g. older Apple MAC computers with D-sub serial port).		
1	DCD	Data Carrier Detect (protocol not used)
2	RXD	Receive Data
3	TXD	Transmit Data
4	DTR	Data Terminal Ready (protocol not used)
5	SGND	Signal Ground
6	DSR	Data Set Ready (protocol not used)
7	RTS	Request To Send (protocol not used)
8	CTS	Clear To Send (protocol not used)
9	RI	Ringer Indicator (protocol not used)

TABLE 2-5. LAN PORT CONNECTOR (J7) PIN ASSIGNMENTS [E-SERIES MODELS ONLY]

PIN	SIGNAL NAME	FUNCTION
1	TX+	Transmit +
2	TX-	Transmit -
3	NOT USED	
4	NOT USED	
5	NOT USED	
6	NOT USED	
7	RX+	Receive +
8	RX-	Receive -

TABLE 2-6. CONTROL INPUT TERMINAL BLOCK ASSIGNMENTS

TERMINAL	FUNCTION
M+	Positive output monitor connection (TB5) (see PAR. 2.7.5.1)
S+	Positive sense connection (TB4) (see PAR. 2.7.5.1)
CS	Current Share bus (TB3) (see PAR. 2.7.7.1)
S-	Negative sense connection (TB2) (see PAR. 2.7.5.1)
M-	Negative output monitor connection (TB1) (see PAR. 2.7.5.1)

TABLE 2-7. ANALOG I/O CONNECTOR (J2) PIN ASSIGNMENTS

PIN	SIGNAL NAME	FUNCTION
1	Cref	Analog signal which programs output current from zero to full scale. Voltage or resistance programming is selected via DIP switch position 2 (See Table 2-2). Refer to PAR. 3.4.2 for voltage programming and 3.4.1 for resistance programming.
2	RELAY_NO	Connected to RELAY_COM (pin 4) for relay energized condition. ⁽¹⁾
3	Vref	Analog signal which programs output voltage from zero to full scale. Voltage or resistance programming is selected via DIP switch position 1 (See Table 2-2). Refer to PAR. 3.4.2 for voltage programming and 3.4.1 for resistance programming.
4	RELAY_COM	Relay common. ⁽¹⁾
5		Reserved.
6	VOLT_RBACK	Analog signal which represents output voltage from zero to full scale (see PAR. 3.4).
7	CURR_RBACK	Analog signal which represents output current from zero to full scale (see PAR. 3.4).
8	REM_INH	Allows single signal to control output on/off. See PAR. 3.2.6.
9	GND	Ground ⁽²⁾
10	RELAY_NC	Connected to RELAY_COM (pin 4) for relay not energized condition ⁽¹⁾
11	GND	Ground
12	ANALOG_CTRL	Enables or disables analog programming (see PAR. 3.4). 1 = Analog programming disabled (default, no connection) 0 = Analog programming accepted (use jumper on mating connector to connect to pin 9, 11, 13 or 15 (ground)).
13	GND	Ground
14	EXT_TRG	Performs same function as SCPI *TRG command if unit is programmed for external triggering via digital remote mode. Transition from 1 (+5V) to 0 (ground) causes values established by VTRIG and CTRIG commands to become VSET and CSET (see PAR 3.3.2, External Triggering).
15	GND	Ground
⁽¹⁾ Refer to PAR. 3.2.17.1 to configure internal relay. ⁽²⁾ All GND connections are common.		

2.3 SOURCE POWER REQUIREMENTS

This power supply operates with the installed circuit breaker from single phase a-c mains power over the voltage and frequency ranges specified in Table 1-3 without adjustment or modification.

2.4 COOLING

The power devices used within the power supply are maintained within their operating temperature range by means of internal heat sink assemblies cooled by three internal (d-c type) cooling fans.

ALL INLET AND EXHAUST OPENINGS AT THE FRONT AND REAR OF THE POWER SUPPLY CASE MUST BE KEPT CLEAR OF OBSTRUCTION TO ENSURE PROPER AIR ENTRY AND EXHAUST. Although not a requirement, it is recommended that side and top vent openings be clear of obstruction for more efficient cooling. Periodic cleaning of the power supply interior is recommended by authorized service personnel only (see KLP Service Manual for instructions).

If the power supply is rack mounted, or installed within a confined space, care must be taken that the ambient temperature, which is the temperature of the air immediately surrounding the power supply, does not rise above the specified limits (see Table 1-3).

2.5 PRELIMINARY OPERATIONAL CHECK

A simple operational check after unpacking and before equipment installation is advisable to ascertain whether the power supply has suffered damage resulting from shipping.

Refer to Figures 2-1 and 2-2 for location of operating controls and electrical connections. Table 2-1 explains the functions of operating controls and indicators.

NOTE: This test must be performed with IEEE 488, RS 232 [standard models], LAN [E-Series models] and ANALOG I/O ports disconnected, and ANALOG I/O SETTINGS switch positions 3 and 5 set to OFF.

1. With **POWER** circuit breaker set to OFF position, connect the power supply to source power (see PAR. 2.7.2).
2. With no load connected, set **POWER** circuit breaker to the ON position (see PAR. 3.2.1). Each time the unit is turned on an internal self-test is performed. After the test has been successfully completed, the unit displays the following:
 - The status display flashes **MODL** (model) for two seconds while the **DC VOLTS** display shows $E_{O_{MAX}}$ and the **DC AMPERES** display shows $I_{O_{MAX}}$. (E.g., for model 75-33, **DC VOLTS** reads 75 and **DC AMPERES** reads 33.)
 - Then the status display flashes **VRT** (Virtual model) for two seconds while the **DC VOLTS** display shows $E_{O_{MAX}}$ and the **DC AMPERES** display shows the current corresponding to 1200W. (E.g., for model 75-33, **DC VOLTS** reads 75 and **DC AMPERES** reads 16.)
 - Then the status display flashes **PROT** (protection limits) for two seconds while the **DC VOLTS** display shows 120% of $E_{O_{MAX}}$ and the **DC AMPERES** display shows 120% of current corresponding to 1200W. (E.g., for model 75-33, **DC VOLTS** reads 90.0 and **DC AMPERES** reads 19.2.)

- Then the status display reads **SET** (setpoint mode), the **DC VOLTS** display reads 0 Volts, the **DC AMPERES** display reads minimum Amperes (see Note 1, below).

NOTES: 1. A minimum programmed current (actual value depends on model) is required to ensure proper operation of the power supply under all load conditions. Programmed current is automatically set to be at least the minimum current.

2. If an error indication is blinking in the Status display, refer to Table 3-1 for an explanation of error codes.
3. Rotate **VOLTAGE** adjust knob clockwise. Verify that **DC VOLTS** display increases in large (X 100) increments.
4. Press and rotate **VOLTAGE** adjust knob clockwise. Verify the **DC VOLTS** display increases in finer increments than step 3, then release knob.
5. Adjust **VOLTAGE** adjust knob clockwise until Status display reads **>MAX**. Tap either **VOLTAGE** or **CURRENT** adjust knob once to enter values. Verify Status display is blank
6. Connect a digital voltmeter (DVM) to the (M+) and (M-) terminals on the rear panel.
7. Press and release **DC OUTPUT** switch to enable the output. Verify **DC OUTPUT** indicator lights.
8. Compare the programmed output voltage value (step 5) with the voltage reading of the DVM; the difference between the two should not exceed 0.05% of the maximum voltage of the unit.
9. Compare the voltage reading of the **DC VOLTS** display with that of the DVM; the difference between the two should not exceed 0.1% of the maximum voltage of the unit.
10. Enter different value for output voltage, then repeat steps 8 and 9 using different values for programmed voltage.
11. Disable the output by pressing and releasing **DC OUTPUT** switch; verify front panel **DC VOLTS** and **DC AMPERES** displays read 0.0V and minimal current and the DC OUTPUT indicator is off.

2.6 INSTALLATION

2.6.1 RACK MOUNTING

The unit is intended to be mounted directly in a 19-inch wide rack. Optional slides (see Table 1-5) can be used.

2.7 WIRING INSTRUCTIONS

Interconnections between an a-c power source and the power supply, and between the power supply and its load are as critical as the interface between other types of electronic equipment. If optimum performance is expected, certain rules for the interconnection of source, power supply and load must be observed by the user. These rules are described in detail in the following paragraphs.

2.7.1 SAFETY GROUNDING

Local, national and international safety rules dictate the earth grounding of the metal cover and case of any instrument connected to the a-c power source, when such grounding is an intrinsic part of the safety aspect of the instrument.

KLP is provided with a three-terminal IEC appliance coupler for connection of the mains supply source, one terminal of which is dedicated for the protective earthing conductor; no other ground or earth connection is required, although the chassis may be separately connected to earth ground for noise or other performance considerations (frame grounding).

The instructions below suggest wiring methods which comply with these safety requirements; however, in the event that the specific installation for the power system is different from the recommended wiring, it is the customer's responsibility to ensure that all applicable electric codes for safety grounding requirements are met.

2.7.2 SOURCE POWER

2.7.2.1 CURRENT RATING

All switchmode power supplies, including the KLP series, present a constant power characteristic to the input power source. Consequently, the power supply draws maximum input current for a given load power at low input voltage, and proportionately less as source voltage is raised according to the formula

$$\text{Input Current} = \text{Output Power} / (\text{Efficiency} \times \text{Input Voltage})$$

The input power circuit breaker of the power supply is rated to support rated load power under worst-case efficiency conditions at the lowest rated source voltage (90V a-c), and provides the necessary overload protection to the power supply's internal circuitry. The user must provide a properly sized and rated mains lead (line cord) and service with a current rating compatible with the anticipated input current. The Table 2-8 provides recommendations for service current rating and mains lead wire size for common a-c mains voltages. Table 1-5 lists line cords currently available as accessories.

TABLE 2-8. INPUT CURRENT SERVICE RATING AND CONDUCTOR SIZES

MAINS VOLTAGE RANGE	CURRENT SERVICE RATING	CONDUCTOR SIZE
90 - 132V a-c, 50/60Hz	20 Amp	#12AWG [2,0 mm ²]
180 - 265V a-c, 50/60Hz	15 Amp	#14AWG [1,6 mm ²]

For continuous operation at output power levels lower than 1000 watts, or for other line cord styles, contact Kepco Applications Engineering for additional options.

2.7.2.2 CONNECTIONS

Source power is connected at the rear panel of the KLP power supply (see Figure 2-2) via the IEC 320-style recessed power inlet connector, which provides interface to a three-wire safety line cord via a polarized mating plug. A user-wirable mating connector is provided. Terminal assignment follows internationally accepted conventions. It is the user's responsibility to ensure that all applicable local codes for source power wiring are met. Kepco also makes a variety of prefabricated safety line cord sets available for connecting KLP to source power via conventional box-mounted receptacles. Table 1-5 lists three popular cord set variants for North American applications. For other options please contact Kepco Sales Engineering with specific requirements.

WARNING



IT IS IMPERATIVE THAT THE USER PROVIDE ALL THREE SOURCE WIRE CONNECTIONS, AS THIS CONNECTION IS THE SAFETY GROUND PROVISION!

2.7.3 D-C OUTPUT GROUNDING

Connections between the power supply and the load and sensing connections may, despite precautions such as shielding, twisting of wire pairs, etc., be influenced by radiated noise, or “pick-up”. To minimize the effects of this radiated noise the user should consider grounding one side of the power supply/load circuit. The success of d-c grounding requires careful analysis of each specific application, however, and this recommendation can only serve as a general guideline.

One of the most important considerations in establishing a successful grounding scheme is to avoid GROUND LOOPS. Ground loops are created when two or more points are grounded at different physical locations along the output circuit. Due to the interconnection impedance between the separated grounding points, a difference voltage and resultant current flow is superimposed on the load. The effect of this ground loop can be anything from an undesirable increase in output noise to disruption of power supply and/or load operation. The only way to avoid ground loops is to ensure that the entire output/load circuit is fully isolated from ground, and only then establish a single point along the output/load circuit as the single-wire ground point.

The exact location of the “best” d-c ground point is entirely dependent upon the specific application, and its selection requires a combination of analysis, good judgement and some amount of empirical testing. If there is a choice in selecting either the positive or negative output of the power supply for the d-c ground point, both sides should be tried, and preference given to the ground point producing the least noise. For single, isolated loads the d-c ground point is often best located directly at one of the output terminals of the power supply; when remote error sensing is employed, d-c ground may be established at the point of sense lead attachment. In the specific case of an internally-grounded load, the d-c ground point is automatically established at the load.

The power supply output terminals (located on the rear panel) for KLP Power Supplies are d-c isolated (“floating”) from the chassis in order to permit the user maximum flexibility in selecting the best single point ground location. Output ripple specifications as measured at the output are equally valid for either side grounded. Care must be taken in measuring the ripple and noise at the power supply: measuring devices which are a-c line operated can often introduce additional ripple and noise into the circuit.

There is, unfortunately, no “best” method for interconnecting the load and power supply. Individual applications, location and nature of the load require careful analysis in each case. It is hoped that the preceding paragraphs will be of some assistance in most cases. For help in special applications or difficult problems, consult directly with Kepco's Application Engineering Department.

2.7.4 POWER SUPPLY/LOAD INTERFACE

The general function of a voltage or current stabilized power supply is to deliver the rated output quantities to the connected load. The load may have any conceivable characteristic: it may be fixed or variable, it may have predominantly resistive, capacitive or inductive parameters; it may be located very close to the power supply output terminals or it may be a considerable distance away. The perfect interface between a power supply and its load would mean that the specified performance at the output terminals would be transferred without impairment to any load, regardless of electrical characteristics or proximity to each other.

The stabilized d-c power supply is definitely not an ideal voltage or current source, and practical interfaces definitely fall short of the ideal. All voltage-stabilized power supplies have a finite source impedance which increases with frequency, and all current-stabilized power supplies have a finite shunt impedance which decreases with frequency. The method of interface between the power supply output and the load must, therefore, take into account not only the size with regard to minimum voltage drop, but the configuration with regard to minimizing the impedance introduced by practical interconnection techniques (wire, bus bars, etc.). The series inductance of the load wire must be as small as possible as compared to the source inductance of the power supply: although the error sensing connection to the load compensates for the d-c voltage drop in the power leads, it cannot completely compensate for the undesirable output effects of the power lead inductance. These lead impedances (both power and sensing leads) are especially important if the load is a) constantly modulated or step-programmed, b) has primarily reactive characteristics, or c) where the dynamic output response of the power supply is critical to load performance.

2.7.5 LOAD CONNECTION - GENERAL

Load connections to the KLP power supply are achieved via the (+) and (–) DC OUTPUT terminals located on the rear panel; (M+) and (M–) outputs are also available at terminal blocks (TB5 and TB1, respectively) located on the panel for load error sense connections.

Configuration of local or remote sensing is facilitated by pre-installed jumpers which configure the unit for local sensing, as shown in Figure 2-2.

NOTE: REGARDLESS OF OUTPUT CONFIGURATION, OUTPUT SENSE LINES MUST BE CONNECTED FOR PROPER OPERATION, EITHER LOCALLY, OR AT THE LOAD (REMOTE). OBSERVE POLARITIES: THE S+ TERMINAL MUST BE CONNECTED TO EITHER M+ (LOCAL) OR +LOAD (REMOTE), AND THE S– TERMINAL MUST BE CONNECTED TO EITHER M– (LOCAL) OR –LOAD (REMOTE).

2.7.5.1 LOCAL SENSING/REMOTE SENSING SELECT

Local sensing (factory default configuration) is established by connecting terminal TB4 (S+) to TB5 (M+) and TB1 (M–) to TB2 (S–) (see Figure 2-2). The power supply is shipped with two jumpers installed to obtain local sensing.

Remote sensing is established by first removing the factory-installed local sensing jumpers between S+ and M+ and between M– and S–. The S+ and S– lines must be connected at the load (see Figure 2-3). A high frequency bypass network consisting of two capacitors connected across the load as shown in Figure 2-3 is recommended to reduce noise in the sense loop.

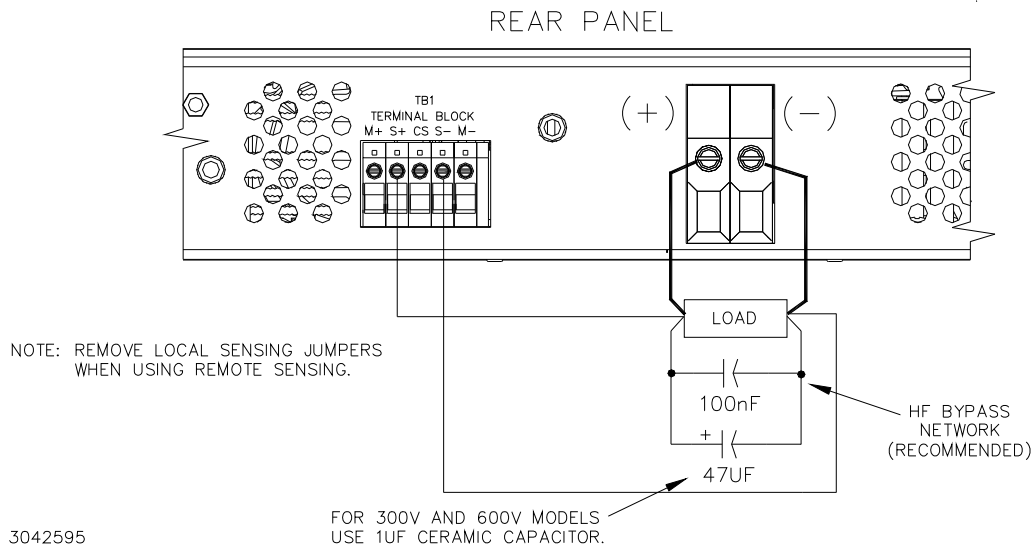

FIGURE 2-3. REMOTE SENSING

2.7.6 SERIES OPERATION

Units may be connected in series to obtain higher output voltages. Each power supply in the series may be protected by a clamping diode connected in its non-conducting direction in parallel with the output. This diode protects the power supply outputs against secondary effects in the event of a load short. (Note that this is NOT the same as the blocking diode used for parallel/redundant operation.) Selection of the clamping diode is entirely dependent upon output voltage/current parameters. The clamping diode must be rated for the maximum voltage and current of the series connection. Several clamping diodes in parallel may be required to meet the total current rating. The user must also respect the $\pm 600\text{V}$ d-c maximum isolation from output to chassis when determining the maximum series voltage. Figure 2-4 shows a series connection of two KLP power supplies using remote sensing. Kepco strongly recommends that series applications employ master/slave control (available on standard models only) as described in PAR's 2.7.8 and 3.2.14. Users considering series configuration of KLP are urged to contact Kepco Application Engineering first to discuss application details before ordering KLP power supplies intended for Series operation.

2.7.7 PARALLEL OPERATION

Identical KLP power supply models may be connected in parallel in order to provide increased output current to a common load (see Figure 2-5). This permits the user to obtain significantly higher load ratings than for a single KLP power supply. The number of power supplies required is determined by dividing the required load current by the current rating of the applicable KLP model, and rounding up to the next whole number when necessary. KLP power supplies utilize active current sharing circuitry to distribute the load current equally among the paralleled units. When operating KLP power supplies in any parallel configuration, load sharing **must** be implemented among the paralleled modules. Kepco strongly recommends that parallel applications employ master/slave control (available on standard models only) as described in PAR's 2.7.8 and 3.2.14.

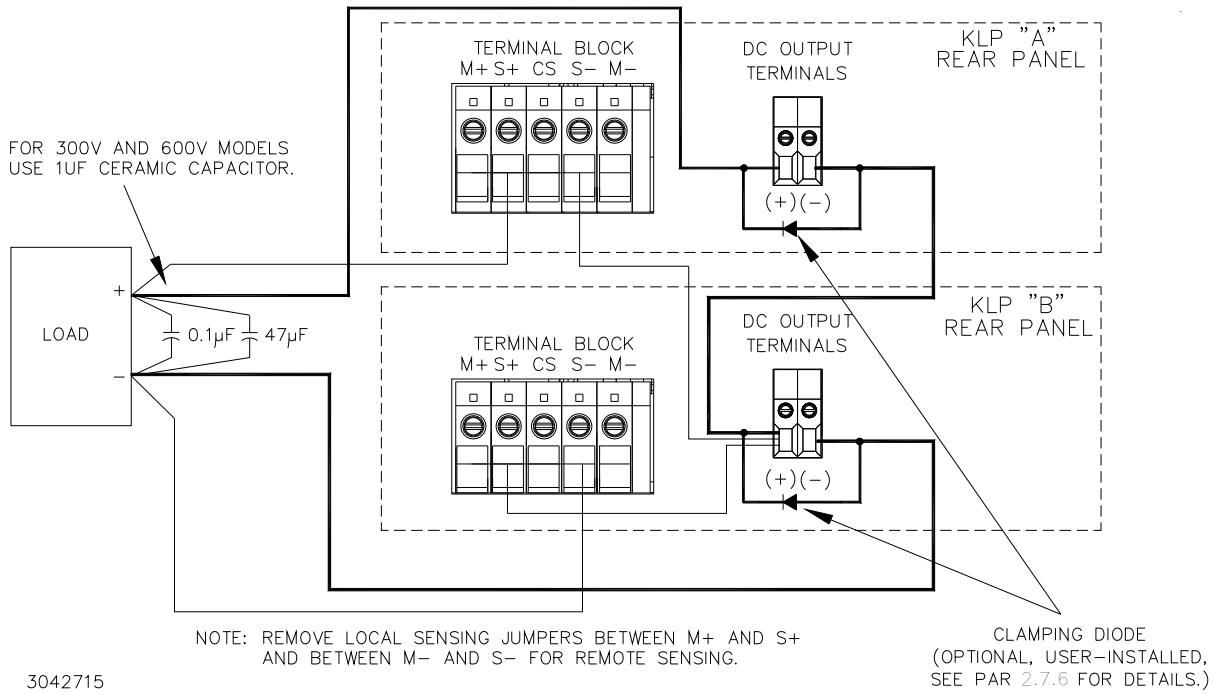

FIGURE 2-4. SERIES CONNECTION USING REMOTE SENSING

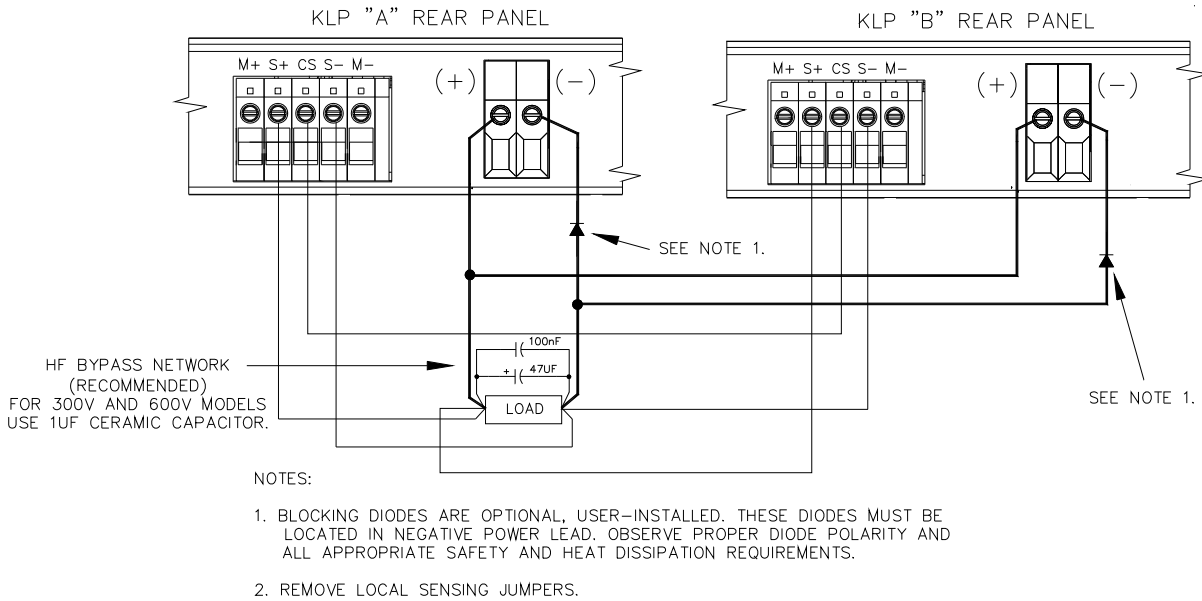

FIGURE 2-5. PARALLEL CONNECTIONS USING REMOTE SENSING

2.7.7.1 LOAD SHARING

When operating two or more power supplies in parallel, either for capacity or redundancy, it is desirable to distribute the load equally among all of the power supplies in order to improve performance, reduce stress and increase reliability. KLP power supplies incorporate active circuitry which forces multiple power supplies wired in parallel to share load current, both in voltage- and current-mode regulation. The KLP employs a single wire connection between paralleled power supplies, forming a master-slave relationship as follows: the highest voltage unit becomes the master, and all of the remaining units are slaved to it via the current share signal (CS, available at the rear panel terminal A3TB3, Figure 2-2), which boosts the slave outputs in order to increase load share. A maximum boost limit prevents the slave units from following a defective master into an overvoltage condition, or from creating a load hazard if either the slave itself or the load sharing system is defective.

When implementing load sharing, the user must ensure that all power supplies are attempting to regulate to the same voltage at the same location, and must minimize the possibility of load share signal corruption; the power supplies should, as nearly as possible, emulate a single large power supply. To this end, the following rules apply:

- a. All error sense connections must terminate to the same physical point, whether the feedback is configured as local or remote sensing.
 - For local error sensing, select one power supply as output regulation point and leave the local error sense jumpers in place. Remove the local error sense jumpers from all other units and use tightly-twisted wire triplets to daisy-chain the S+, CS and S- terminals to the first power supply.
 - For remote error sensing the same procedure is followed as for local sensing, except that the local error sense jumpers are removed from the first power supply as well, and a tightly-twisted wire pair is connected from the S+ and S- terminals of the first power supply to the load regulation point. Install the HF bypass network indicated in Figure 2-5 across the error sense termination points.
- b. The power supplies should be located as near to each other as possible, preferably in vertically adjacent (stacked) positions. Power terminations must be bussed together using adequately-sized interconnecting conductors, both between the paralleled outputs and from the power supply assembly to the load. Current rating of the conductors must accommodate the total maximum current contribution based on the programmed current regulation points of all power supplies. For the low-voltage models (10V, 20V, 36V) Kepeco advises the use of bus bar conductors where possible; for higher voltage models (75V - 600V), appropriately sized twisted conductor pairs terminated with wire ferrules are recommended (contact Kepeco Applications Engineering for details).
- c. For local error sensing, the power outputs should be daisy-chained to the power supply output terminals serving as the regulation point, and from there to a connection run to the load. For remote sensing, load connections may be run directly from each power supply's output terminals to the error sense regulation point, or daisy-chained as for remote sensing connections. In each case, the connections from the power supply outputs to the load must be properly sized for maximum current and configured to minimize inductance and noise, either through twisted wires, power coaxial cabling or parallel or laminated bus bars. For guidance on wire sizing see the nomograph at www.kepecopower.com/nomomax.htm.

- d. The output voltage setting of all power supplies must be adjusted to the same voltage as closely as possible, and in any case within a $\pm 1\%$ error band, to ensure adequate range of the load sharing circuit. In addition, the output current setting should be identical for all power supplies and high enough to support all load requirements, including both static and transient loading conditions.

2.7.8 MASTER/SLAVE CONFIGURATIONS [STANDARD MODELS ONLY]

Master/slave configurations of power supply pairs can be used to allow changes to output voltage/current of one supply (master) to affect the output of the other (slave). Both units of a master/slave configuration must be identical models. Master/slave control is implemented using the RS 232 ports. After connecting the series or parallel pair (see PAR. 2.7.6 or 2.7.7, respectively), use a null modem cable, minimum length 0.5 foot, DB9F-DB9F, to connect the RS 232 ports of both power supplies. Then refer to PAR. 3.2.14 to complete the setup of each power supply in the master/slave configuration.

If GPIB control of the master/slave pair is desired, the user must connect to the master unit using an "in-line" style connector, as the commonly-used stackable connector will interfere physically with the RS 232 connector above it. Contact Kepco Sales Engineering for additional guidance.

2.7.9 ANALOG I/O CONNECTIONS

The Analog I/O Port connector, located on the rear panel of the KLP power supply (see Figure 2-2), provides access for all analog programming inputs and status signal outputs. In addition, an external trigger input is available for use with SCPI *TRG and TRIG commands. Refer to Table 2-7 for analog I/O programming signal pin assignments and descriptions.

These signals must be protected from radiated and conducted noise as well as from physical contact with non-valid driving sources. The following subsections address specific programming signal applications; in general, however, when accessing this connector from distant locations or high-noise environments, it is recommended that a shielded cable be used, with the shield terminated to the system's single point ground.

a. Analog Programming Enable (ANALOG_CTRL)

Connect pin 12 (Analog Control) to pin 9, 11, 13, or 15 (ground) to enable analog I/O programming.

b. External Voltage and Current Programming (V_Ref and C_Ref)

Twist the voltage programming signal V_Ref (pin 3), Current Programming signal C_Ref (pin 1) and ground (pin 9, 11, 13, or 15). Configure Analog I/O switch positions 1 and 2 to use either voltage or resistance as the programming source. Factory default for full scale output is 10V or 10 Kohms (see par. 4.3.3 to set lower values for full scale output).

c. Voltage and Current Readback (VOLT_RBACK and CURR_RBACK)

Twist the voltage readback signal VOLT_RBACK (pin 6), Current readback signal CURR_RBACK (pin 7) together with ground (pin 9, 11, 13, or 15). Full scale readback voltages are identical to selected full scale programming voltages (see PAR. 4.3.3).

d. Remote Inhibit (REM_INH)

Twist remote inhibit (pin 8) together with ground (pin 9, 11, 13, or 15). See PAR. 3.2.17.3.1 to configure active high or low and PAR. 3.2.6 to enable/disable the output using remote inhibit.

e. Fault Connections (RELAY_NC, RELAY_COM, RELAY_NO)

It is recommended that normally open and normally closed relay signals RELAY_NC (pin 10) and/or RELAY_NO (pin 2), respectively, be twisted together with RELAY_COM (pin 4) as needed to eliminate noise pickup. See PAR. 3.2.17.1 to configure internal relay.

f. External Trigger (EXT_TRIG)

External Trigger may be used with the SCPI TRIG commands (see KLP Developer's Guide) during digital remote operation. For noise suppression it is recommended that wires from EXT_TRIG, pin 14 and ground (pin 9, 11, 13, or 15) be twisted together.

2.8 DIGITAL CONNECTIONS

The following paragraphs describe the connections required to use the GPIB, RS 232 [standard models only] or LAN [E-Series models only] ports for remote control of the unit.

2.8.1 GPIB CONNECTIONS

Your computer must have a GPIB interface card installed. Connect the power supply to the computer's GPIB interface card. Use a standard GPIB interface cable at the GPIB port on the rear panel (See Figure 2-2). Refer to Table 2-3 for GPIB port pin assignments. Refer to PAR. 3.2.12 to change the default GPIB address (6) from the front panel.

2.8.2 RS 232 CONNECTIONS [STANDARD MODELS ONLY]

Communications between KLP, considered data terminal equipment (DTE), and data communications equipment (DCE), e.g. a modem, requires a patch cable, or one with a pin-for-pin relationship between terminating connectors. A null modem cable (see Table 1-5) is necessary for nearly all applications, with the exception of those in which the RXD and TXD line transposition is accomplished via external hardware (e.g. older Apple MAC computers with D-sub serial port). See Table 2-4 for RS 232 port pin assignments. Connect the cable to the KLP at the RS 232 port located on the rear panel (See Figure 2-2). Refer to PAR. 3.2.13 to change the default baud rate (38400) from the front panel.

2.8.3 LAN CONNECTIONS [E-SERIES MODELS ONLY]

Connect the KLP to the LAN via the RJ 45 LAN port located at the rear panel (See Figure 2-2). Refer to Table 2-5 for LAN port pin assignments. Refer to PAR 3.2.15 to configure the LAN interface from the front panel. Some configuration can also be done through the web interface (see PAR. 3.3.6.4). Refer to the KLP Developer's Guide for the associated SCPI commands

SECTION 3 - OPERATION

3.1 GENERAL

This section explains how to operate the KLP Power Supply. Series KLP feature three modes of operation:

- Local Mode (see PAR. 3.2): This is the default operating mode, providing full access to all programming and readback functions via front panel displays, controls, and indicators.
- Digital Remote Mode (see PAR. 3.3): This mode is selected via commands transmitted through one of the two digital ports. One port is configured for IEEE-488 (GPIB), The second port is either an RS 232 port [standard models] or a LAN port [E-Series models]. The digital ports are described in the KLP Developer's Guide. The power supply automatically goes into digital remote mode when commands are accepted via one of the digital ports.
- Analog Remote Mode (see PAR. 3.4): This mode is selected via a jumper wire at the analog programming port prior to initial turn-on, and provides limited access to programming and readback functions.

3.2 LOCAL MODE OPERATION

Local operation of the KLP Power Supply is accomplished via the front panel switches and controls illustrated in Figure 2-1 and described in detail in Table 2-1. Separate 4-digit LEDs display actual output voltage and current; these same displays show set points and limits as well. Status and fault indications are provided by a 4-character alpha-numeric display.

3.2.1 TURNING THE POWER SUPPLY ON

1. To turn the power supply on, set **POWER ON/OFF** circuit breaker (see Figure 2-1) to ON. Apply firm, continuous pressure to rocker actuator until fully engaged (right side of rocker actuator locked parallel to front panel). If actuator does not lock when released, allow actuator to return to starting position, then wait a few seconds before repeating turn-on sequence.



CAUTION: DO NOT attempt to “tease” the switch contacts closed by repetitive press-and-release action. The circuit breaker is “trip-free” design; if overload exists, contacts cannot be held closed by actuator. After turning the unit off, allow at least 5 seconds before turning the unit on again.

2. When the power supply is turned on, it performs a self-test and displays the following information:
 - Status display flashes **KLP** for 2 seconds while **DC VOLTS** and **DC AMPERES** displays show the maximum voltage and current capability of the unit.
 - Status display flashes **LAN** for 2 seconds if unit is an E-Series model
 - Status display flashes **RODC** for 2 seconds if unit has the Rapid Output Discharge Circuit option installed.
 - Status display flashes **VIRT** for 2 seconds while **DC VOLTS** and **DC AMPERES** displays show the maximum voltage and current allowed for a previously programmed virtual model. To reprogram the maximum allowable voltage and/or current, refer to PAR. 3.2.9 to define a virtual model.

- Status display flashes **PROT** for 2 seconds while **DC VOLTS** and **DC AMPERES** displays show previously stored OVP and OCP trigger levels. NOTE: to reprogram OVP or OCP, refer to PAR. 3.2.11.

NOTE: To eliminate the display of model, virtual model, and protection levels on power-up, refer to PAR. 3.2.17.2 for quick boot.

- For E-Series models, the LAN indicator blinks rapidly during initialization. If an IP address is found, it stays on without blinking. If an IP address is not found, the LAN indicator stays off.
- If any fault is configured for AUTO recovery (see PAR. 3.2.17.3.2), the status display flashes **AUTO** for one second.
- If remote inhibit is active (see PAR. 3.2.6) upon power-up, the status display flashes **rINH** for one second.
- If an error occurs, an error code is displayed in the status display (see Table 3-1).

TABLE 3-1. POWER-UP BUILT-IN TEST ERROR CODES

ERROR CODE	MEANING
E310	System Error
E313	Calibration Memory Error
E315	Configuration Memory Error
E341	Memory Error (CRC)
E330	Self Test Error
Ecal	Calibration Error - The unit will try to restore the previous calibration.
Eclp	Previous Calibration Error - After detecting a Calibration Error (Ecal) and trying to use the previous calibration, an error was detected, and the unit will attempt to restore the factory calibration.
Eclf	Factory Calibration Error - The unit has failed to restore the factory calibration after failing to restore the previous calibration. The unit will not operate after this error has been displayed and must be referred for service.
Epot	Digital pot fails initial test.
NOTE: During power-up the power supply performs detailed software check sequences. If a failure is detected during power-up, the DC VOLTS and DC AMPERES displays are blanked and the Status display shows an error code. For errors that occur after power-up, refer to the Developer's Guide for typical error codes and possible causes. If E302 is displayed, see PAR. 3.2.17.1 for details. For these and all other error codes, refer to authorized service personnel if corrective action is required.	

3. After a successful self test, the default conditions upon power up are as follows:

- Status display shows **SET**.
- output is disabled (green **DC OUTPUT** indicator is off). If remote analog mode is selected (PAR. 3.4), output is enabled unless Remote Inhibit, pin 8 of the Analog I/O Connector (see Figure 2-2 and Table 2-7) is grounded.

- **DC VOLTS** and **DC AMPERES** displays show programmed output conditions: either 0 Volts, minimum Amperes (see NOTE, PAR. 3.2.1) or, if DIP switch position 3 enabled (see Table 2-2), previously saved setpoint values in effect upon power off.

NOTE: A minimum programmed current is required to ensure proper operation of the power supply under all load conditions. Programmed current is automatically set to be at least the minimum current (actual value depends on model, see Table 1-2).

- Since the output is off, Constant Voltage (**CV**) mode indicator (green LED) and Constant Current (**CC**) indicator (amber LED) are off.

3.2.2 SETTING LOCAL/REMOTE MODE

LOCAL MODE. When the power supply is turned on, it is automatically set to Local mode as long as Analog I/O port pin 12 is not grounded. In local mode the Status display is normally blank.

DIGITAL REMOTE MODE. The power supply will automatically go into digital remote mode when digital remote commands are accepted via the GPIB, RS 232, or LAN ports. In digital remote mode the power supply normally shows **dRem** in the status display. The LAN indicator [E-Series models only] is on when a valid IP address has been found. When in digital remote mode, all front panel controls are disabled. If desired, local mode can be restored by pressing both **VOLTAGE** and **CURRENT** controls simultaneously; the power supply will then remain in local mode until another digital command is received, causing the unit to return to remote digital mode. To disable local mode entirely, see PAR. 3.2.2.1 for front panel lockout.

For E-Series models the OPERATE INSTRUMENT web page must not be active when restoring local mode. Changes to the unit configuration made while in local mode will not appear on the OPERATE INSTRUMENT web page until remote digital control is restored: either refresh the open browser page or close the browser and start a new session (**dREM** reappears in the status display).

NOTE: During both LOCAL and DIGITAL REMOTE operation, the analog readback signals (voltage and current) remain available, as does the remote inhibit signal; only programming signals are disregarded.

ANALOG REMOTE: With power supply turned off, ground Analog I/O port pin 12. Refer to PAR. 2.7.9 to configure the Analog I/O Port; refer to Table 2-2 to configure the Analog I/O switch. When the power supply is turned on, the status display shows **aRem** (Analog Remote programming selected). The unit will accept Analog Remote commands (see PAR. 3.4) and front panel controls are disabled. Local mode can be restored by pressing the **VOLTAGE** and **CURRENT** controls at the same time. Once local mode has been restored, analog remote programming is disabled until the unit is powered off, then on again.

NOTE While Analog Remote programming is active, the unit will respond to digital queries, but will not respond to most digital commands, except for the front panel unlock command (see PAR. 3.2.2.1). VOLT, CURR and OUTP commands that attempt to change the output state will produce 221 errors (Settings Conflict). If unit calibration is initiated, the unit will immediately exit analog remote control and enter digital remote control. Resumption of remote analog control requires that source power to the unit be cycled.

3.2.2.1 REMOTE WITH LOCAL (FRONT PANEL) LOCKOUT

To prevent unauthorized setting of the power supply to Local mode, a local lockout mode can be enabled which prevents the power supply from being restored to local mode via the front panel.

With the power supply turned off, set the ANALOG I/O DIP switch, position 5 (see Table 2-2) to ON. Now when the power supply is turned on the status display will read one of the following:

LOCK - front panel controls locked, analog mode not enabled and no digital commands received.

aRw1 (analog Remote with local lockout) - front panel controls locked, analog mode enabled

dRw1 (digital Remote with local lockout) - front panel controls locked, analog mode disabled and a digital command received.

Once the front panel is locked, it can only be unlocked by either of the following:

- turn the power supply off, set ANALOG I/O DIP switch position 5 to OFF, and then power up again.
- send the following SCPI command via GPIB, RS 232 or LAN port:
SYST:KLOC OFF

NOTE: If the front panel is unlocked by SCPI command, the unit will be set to Remote with Local Lockout when it is turned on again. Set ANALOG I/O DIP switch position 5 to OFF to disable Remote with Local Lockout.

3.2.3 MENU STRUCTURE

Many KLP functions are accessed via the **FUNCTION** switch. This switch is disabled when the unit is in setpoint mode (If the status display shows **SET**, tap either the **CURRENT** or **VOLTAGE** controls to take the unit out of setpoint mode (status display goes from **SET** to blank).

Pressing **FUNCTION** switch using a thin tool (e.g., a paper clip) accesses the menu and submenu structure indicated on the four-character status display (see Figure 3-1). To scroll through menu and submenu selections rotate either the **DC VOLTS** or **DC AMPERES** control. Tap the **DC OUTPUT** switch to select and proceed. Exit any submenu by tapping the **DC OUTPUT** switch when the status display shows **RTN** to return to the previous menu. To exit the Function menu after all submenus have been exited, tap the **DC OUTPUT** switch when the status display shows **EXIT**. Pressing the **FUNCTION** switch once within any menu or submenu will also exit the Function menu.

3.2.4 SETTING VOLTAGE AND CURRENT CONTROL COARSE/FINE PREFERENCE

The **VOLTAGE** or **CURRENT** controls are shipped from the factory so that rotating either control produces a coarse adjustment; pressing the control in while rotating produces a fine adjustment. This can be reversed, so that normal rotation produces a fine adjustment and pressing the control in while rotating produces a coarse adjustment.

1. If the status display shows **SET**, tap either the **CURRENT** or **VOLTAGE** controls to take the unit out of setpoint mode (status display goes from **SET** to blank).
2. Using a thin tool (e.g., a paper clip), press the **FUNCTION** switch once, then rotate either the **VOLTAGE** or **CURRENT** control until the status display reads **UTIL**.

- Tap **DC OUTPUT** switch, then rotate either the **VOLTAGE** or **CURRENT** control until status display reads **ADJ**. The **DC VOLTS** display shows **C--F** when normal rotation produces coarse adjustment, **F--C** when normal rotation produces fine adjustment.

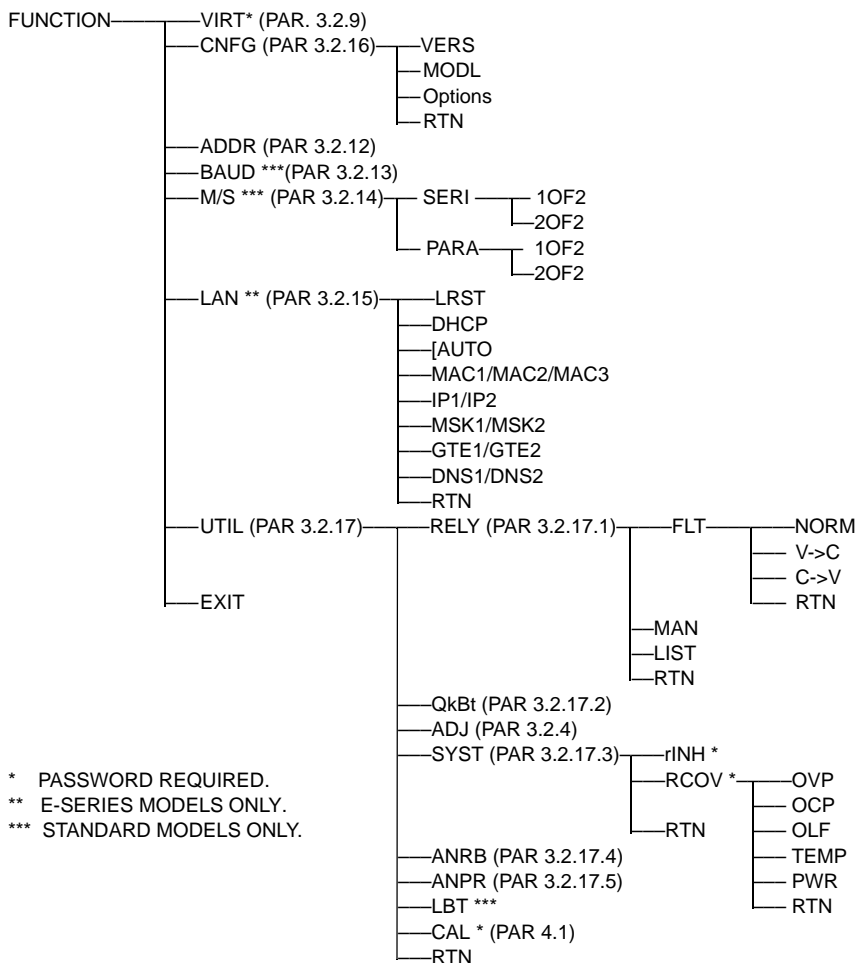

FIGURE 3-1. FUNCTION SWITCH MENU STRUCTURE

- To change the preference, tap **DC OUTPUT** switch once. The status display changes to **ADJ?** and the **DC VOLTS** display starts to blink. Rotate either the **VOLTAGE** or **CURRENT** control to alternate between **C--F** and **F--C**.
- Tap **DC OUTPUT** switch to accept new preference. status display briefly shows **WAIT**, then changes to **ADJ** and **DC VOLTS** display stops blinking. To exit rotate either the **VOLTAGE** or **CURRENT** control until status display reads **RTN** and tap **DC OUTPUT** switch to return to previous menu.

3.2.5 ENABLING/DISABLING OUTPUT POWER

When the power supply is turned on, the output is normally disabled (**DC OUTPUT** indicator is off) and the **DC VOLTS** and **DC AMPERES** displays show the programmed output voltage and current set points and the status display reads **SET**. However, if the unit has been set to **AUTO** fault recovery, the output may be enabled when the unit is turned on (see PAR. 3.2.17.3.2).

To enable the output, first tap either **VOLTAGE** or **CURRENT** control once to exit setpoint mode (**SET** disappears from the status display) then tap the **DC OUTPUT** switch once. The **DC OUTPUT** indicator goes on to indicate the output is enabled.

To disable the output, press and release the **DC OUTPUT** switch again. The **DC OUTPUT** indicator goes off.

While in the setpoint mode (Status display reads **SET**) the output cannot be turned on (pressing **DC OUTPUT** has no effect). If output was on while setpoint mode was entered, pressing **DC OUTPUT** will disable the output.

For setpoint adjustment refer to PAR. 3.2.10.2. To enable/disable the output using Remote inhibit refer to PAR. 3.2.6. See PAR. 3.2.17.3.2 for details about automatic enabling of the output after recovering from a fault.

3.2.6 ENABLING/DISABLING THE OUTPUT USING REMOTE INHIBIT

The Remote Inhibit (**rINH**) signal applied to analog I/O port pin 8 (see PAR. 2.7.9) can be used as a remote inhibit or emergency shutdown when in either Local or Digital modes. One use of this signal in either Local or Digital mode is as a safety interlock to prevent a potentially hazardous output during system servicing. When in Analog Control mode this signal can be used for remote on/off control of the output.

This signal is a TTL signal that can be programmed to be active (turn the output off) for either a TTL high (logic 1) or TTL low (logic 0) (see PAR. 3.2.17.3.1).

If **rINH** is set to be active for low, an open condition at pin 8 causes the output state to default to ON.

If **rINH** is set to be active for high, an open condition at pin 8 causes the output to remain off. If quick-boot (see PAR. 3.2.17.2) is off and **rINH** is set to high, upon power-up the status display will flash **rINH** at the end of the start-up sequence to remind the user of this condition (see PAR. 3.2.1).

LOCAL CONTROL MODE. For Local Control mode, the Remote Inhibit signal acts as a true remote inhibit. If Remote Inhibit is asserted, the output will be disabled even if **OUTPUT ON** switch is pressed. To enable the output after Remote Inhibit has been asserted, first withdraw Remote Inhibit, then tap **OUTPUT ON** switch. If **OUTPUT ON** switch is pressed while Remote Inhibit is asserted, the command is ignored and **rINH** is flashed once in the status display

DIGITAL CONTROL MODE. For Digital Control mode, the Remote Inhibit signal acts as an emergency shutdown. Asserting Remote Inhibit overrides **OUTPUT ON** commands and forces an **OUTPUT OFF** state. This is true even if **AUTOMATIC** recovery from a source power or over-temperature fault should return the output to a previous enabled state. If Remote Inhibit is asserted, the output will be disabled even if **OUTPUT ON** command is sent. To enable the output after Remote Inhibit has been asserted, first withdraw Remote Inhibit, then send **OUTPUT ON** command. If the **OUTPUT ON** command is sent while Remote Inhibit is asserted, the command will be ignored, and **rINH** flashes in the status display every two seconds.

ANALOG CONTROL MODE. If the output has previously been enabled, asserting/withdrawing Remote Inhibit allows the output to be enabled/disabled remotely. If the output is already off, this signal has no effect; however if Remote Inhibit is active, and an attempt is made to turn the output on, the output will stay off and **rINH** will appear in the status display. If Remote Inhibit is withdrawn, the output will go to the levels programmed on **Vref** and **Cref** without warning.

3.2.7 CHECKING VOLTAGE/CURRENT SETPOINTS

CAUTION: BEFORE ENABLING THE OUTPUT ALWAYS CHECK THE SETPOINTS TO AVOID POSSIBLE DAMAGE TO THE LOAD.

Check the voltage and current set points by tapping either the **VOLTAGE** or **CURRENT** control. The status display reads **SET**, and the **DC VOLTS** and **DC AMPERES** displays show the stored setpoints.

To accept the displayed value, tap the associated adjustment control again. To change the value, rotate the control (see PAR. 3.2.4 to set coarse/fine preference), then tap the adjustment control again to accept the new setting. If you decide not to change the value after rotating the control, the previous setpoint value will be restored after about 20 seconds of inactivity, then tap either adjustment control to accept. If a fault has been configured for AUTO recovery, the status display flashes **>AUTO** for one second upon leaving Setpoint mode (see PAR 3.2.17.3.2).

3.2.8 PASSWORD PROTECTED FUNCTIONS

Certain functions, such as system configuration and calibration, can only be changed from the front panel after entering the unit password. The password is four characters long comprised of numeric characters only. Refer to PAR. 4.5 to change the password. Table 4-1 shows the factory default password for each model.

1. The status display shows **PASS** (password) and the display shows 0000 with the left-most character blinking. Rotate **CURRENT** control to select a number from 0-9. Tap **CURRENT** control to advance to next digit.
2. Repeat this process until all four digits have been selected. Tap **DC OUTPUT** switch to accept the number. If password is incorrect, the status display reads "**ERR**". Repeat this step to enter the correct password, or press the **FUNCTION** switch to exit.

3.2.9 DEFINING A VIRTUAL MODEL

The virtual model is defined by establishing a maximum programmable voltage and current for the unit within the 1200W power limitation and the maximum voltage and current ratings listed in Table 1-2. Once established, the unit will not accept programmed values beyond these values whether from the front panel in local mode, or from the digital (GPIB, RS 232, or LAN) or analog input ports in remote mode. The virtual model settings are password-protected (see PAR. 3.2.8).

A multitude of possible 1200W power supplies may be emulated by defining the maximum voltage and current. For example, some of the possible power supplies that a KLP 36-60 can emulate are: 36V, 33A (1200W), 20V, 60A (1200W), 30V, 40A (1200W) and 35V, 30A (1050W). Refer to Table 1-2 and Figure 1-2 for the acceptable operating regions for each model.

NOTE: Decreasing full scale voltage and/or current does not improve programming resolution.

Whenever a virtual model is set, overvoltage and overcurrent protect limits (see PAR. 3.2.11) are reset to 120% of the new maximum value (except where necessary to maintain minimum values as noted in PAR. 3.2.11). Also, if position 3 of the Analog I/O DIP switch is set to recall previous setpoint values upon power-up (see Table 2-2 and PAR. 3.2.10.3), the previous setpoint value is cleared so that after changing the virtual model the initial powerup will be at 0 Volts, minimum current. In addition, the following parameters which are not accessible from the

front panel (see PAR. 3.3.2) should be checked to ensure that there are no settings outside the range permitted by the new maximum programmable voltage and current.

- Storage of User-programmed Active Settings (Save/Recall).
- User-determined output Sequences.
- External Triggers: VOLT:TRIG and CURR:TRIG values
- Sequences programmed using LIST commands.

To define a virtual model, proceed as follows.

1. If the status display shows **SET**, tap either the **CURRENT** or **VOLTAGE** controls to take the unit out of setpoint mode (status display goes from **SET** to blank)
2. Using a thin tool (e.g., a paper clip), press the **FUNCTION** switch once so that the status display reads **VIRT**. The **DC VOLTS** and **DC AMPERES** displays show the programmed maximum voltage and current of the virtual model. To exit without changing the virtual model, rotate either **VOLTAGE** or **CURRENT** control until Status display reads **EXIT**, then tap **DC OUTPUT** switch. To change the virtual model limits proceed to step 3.
3. Tap the **DC OUTPUT** switch once. The status display shows **PASS**. Enter the unit password (see PAR. 3.2.8) and tap **DC OUTPUT** switch to accept the number. When the password is accepted, the virtual model settings in the **DC VOLTS** and **DC AMPERES** displays begin blinking.
4. Rotate **VOLTAGE** and **CURRENT** controls until desired values appear in **DC VOLTS** and **DC AMPERES** displays. Tap the associated control to change digits. Pressing and holding the control in while turning changes adjustment resolution (see PAR. 3.2.4). Under no conditions will the power supply accept limits beyond its maximum ratings of voltage and current. As the primary parameter is increased, the power supply will automatically decrement the secondary parameter as necessary to maintain maximum output power at 1200 Watts. Maximum current shown on **DC AMPERES** display is automatically limited to 1200W maximum.
5. Press **DC OUTPUT** switch to accept virtual model settings. The unit displays **done**.

NOTE: Accepting a new virtual model resets the setpoints to zero Volts and minimum Amperes, resets the OVP and OCP values and, if DIP switch position 3 is enabled, clears stored setpoints of voltage and current as described above.

3.2.10 SETTING VOLTAGE OR CURRENT

The **VOLTAGE** and **CURRENT** controls adjust output voltage and current limit, respectively, when the unit is in constant voltage (CV) mode and adjust voltage limit and output current, respectively, when the unit is in constant current (CC) mode. The mode (CV or CC) is determined by the load together with the programmed settings. As long as the voltage across the load produces a current that is less than the programmed Current setpoint, the unit operates in CV mode (voltage programmed to voltage setpoint, current limited by current setpoint). If the load changes to the point that current through the load reaches the current setpoint, the unit automatically enters CC mode (current programmed to current setpoint, voltage limited by voltage setpoint).

Output voltage or current can be set at the front panel in two ways: Real-time adjustment (PAR 3.2.10.1) or Setpoint adjustment (PAR. 3.2.10.2).

3.2.10.1 REAL-TIME VOLTAGE/CURRENT ADJUSTMENT

Rotating the associated control will change the output voltage or current in real-time only if the output is enabled. If the unit is in constant voltage mode (**CV** indicator lit) the **DC VOLTS** display shows the actual output voltage as the **VOLTAGE** control is rotated. Similarly, if the unit is in constant current mode (**CC** indicator lit) the **DC AMPERES** display shows the actual output current as the **CURRENT** control is rotated.

NOTE: If the unit is in CV mode, rotating the **CURRENT** control will affect the current limit even though the **DC AMPERES** display does not change since it is showing actual output current. Similarly, rotating the **VOLTAGE** control while in CC mode affects the voltage limit. To change the limits to a precise value, refer to PAR. 3.2.10.2, Setpoint Adjustment.

Voltage and current settings are not allowed to exceed either a) the virtual model setting or b) 83.3% of the protection value. Attempts to set voltage or current beyond these limits will not be accepted. The status display shows either **>MAX** for virtual model limits, **>OVP** for voltage protection, or **>OCP** for current protection to indicate which limit is being exceeded.

3.2.10.2 SETPOINT ADJUSTMENT

Tap either the **VOLTAGE** or **CURRENT** control to initiate setpoint adjustment (status display reads SET). The previous setpoint is visible on the corresponding **DC VOLTS** or **DC AMPERES** display.

1. Rotate the corresponding control to change the setpoint as viewed on the corresponding LED display. If you decide not to change the setting after rotating the control, the previous setpoint value is restored after approximately 20 seconds. Tap either adjustment control again to accept the displayed setting.
2. In the setpoint mode, both coarse and fine adjustment are available (see PAR. 3.2.4 to set coarse/fine preference). The coarse adjustment is approximately 100X the fine adjustment resolution.

Setpoint adjust can be done with output either on or off, however the output can not be enabled while setpoint is active (See PAR. 3.2.5).

Voltage and current settings are not allowed to exceed either a) the virtual model setting or b) 83.3% of the protection value. Attempts to set voltage or current beyond these limits will not be accepted. The status display shows either **>MAX** for virtual model, **>OVP** for voltage protection, or **>OCP** for current protection to indicate which limit is being exceeded. If a fault has been configured for AUTO recovery, the status display flashes **>AUTO** for one second upon leaving Setpoint mode (see PAR 3.2.17.3.2).

3.2.10.3 LAST SETTING RECALL

KLP is capable of saving the last setpoint values for voltage and current prior to unit shutdown, and recalling them when the unit is next turned on. Enable this function prior to power-up by setting Analog I/O Switch 3 to the ON (down) position (see Table 2-2 and Figure 2-2). Upon next power-up, each setpoint entry for voltage and current is stored in non-volatile memory, with latest settings displacing prior ones. When the power supply is turned off, the last settings are saved and automatically retrieved at next power-up as the starting setpoints. Note that this function applies to setpoint entries only (PAR 3.2.10.2); output changes entered in real-time mode (PAR 3.2.10.1) are not saved. To disable this function, turn the unit off and set Analog I/O Switch

3 to the OFF (up) position; at next power-up, the stored value buffer is cleared and setpoints will default to zero volts and minimum current.

NOTE: If the virtual model for the power supply is altered, the last settings are reset to zero volts and minimum current. Last output state (ON or OFF) is not retained; upon restart the unit defaults to setpoint mode. See AUTOMATIC fault recovery mode (PAR. 3.2.17.3.2).

3.2.11 VIEWING/CHANGING OVERVOLTAGE OR OVERCURRENT PROTECTION VALUES

Overvoltage and Overcurrent protection values can be individually programmed. The range for overvoltage and overcurrent values are 0.2 to $1.2 \times E_{Omax}$ and 0.72 to $1.2 \times I_{Omax}$. If the output voltage/current exceeds the overvoltage/overcurrent protection value, the protection circuit latches the output off, flashes an overvoltage (OVP) or overcurrent (OCP) protection error message on the status display and sets a status bit that can be retrieved through the RS 232, GPIB or LAN port. The unit must be cycled on and off to restore the output. If the internal relay is programmed to FAULT mode (see PAR. 3.2.17.1), the N.O. and N.C. contacts of the relay provide status flags via the Analog I/O port connector. The maximum values are $1.2 \times E_{Omax}$ for overvoltage protection, and $1.2 \times I_{Omax}$ for overcurrent protection.

A built-in feature prevents the unit from encroaching upon the above margins for OVP and OCP. For example, if OVP and OCP are set to 12V and 72A, respectively, programming of the output is automatically limited to 10V and 60A.

NOTE: When a virtual model is defined (PAR. 3.2.9), OVP and OCP are automatically set 20% and 20%, respectively, above the maximum programmable values established by the virtual model. If OVP or OCP are lowered by the user, valid settings will actually be lower than the virtual model limits because values within 20% guard band of OVP or OCP are prohibited.

The OVP and/or OCP limits can be changed as follows:

1. Using a thin tool (e.g., end of paper clip), press and hold the **PROTECT** switch. The output is switched off, setting voltage to zero Volts, and current to a minimal value, and the status display shows **PROT**. The **DC VOLTS** and **DC AMPERES** displays show the corresponding overvoltage and overcurrent protection setpoints while the **PROTECT** switch is held in.
2. To change the values, operate the corresponding adjustment control while holding the **PROTECT** switch in. When the **PROTECT** switch is released, the protection values showing in the **DC VOLTS** and **DC AMPERES** displays are entered as the new protection values.

3.2.12 CHANGING GPIB ADDRESS

KLP supports GPIB addresses from 1 to 30; the factory default GPIB address is 6. To change the address from the front panel proceed as follows:

1. If the status display shows **SET**, tap either the **CURRENT** or **VOLTAGE** controls to take the unit out of setpoint mode (status display goes from **SET** to blank)
2. Using a thin tool (e.g., a paper clip), press the **FUNCTION** switch once, then rotate either the **CURRENT** or **VOLTAGE** control until the display reads **ADDR**; the active GPIB address is visible in the **DC AMPERES** display. To change the address, proceed to step 3.
3. Tap the **DC OUTPUT** switch. The GPIB address visible in the **DC AMPERES** display begins blinking.

4. Rotate the **CURRENT** control to change the GPIB address, then tap the **DC OUTPUT** switch to accept the displayed GPIB address. The display briefly reads **DONE**, then returns to **ADDR**.
5. Rotate the **VOLTAGE** control until display reads **EXIT**, then tap the **DC OUTPUT** switch to exit

3.2.13 CHANGING RS 232 BAUD RATE [STANDARD MODELS ONLY]

The factory default RS 232 baud rate is 38400. To change the baud rate from the front panel proceed as follows:

1. If the status display shows **SET**, tap either the **CURRENT** or **VOLTAGE** controls to take the unit out of setpoint mode (status display goes from **SET** to blank)
2. Using a thin tool (e.g., a paper clip), press the **FUNCTION** switch once, then rotate either the **CURRENT** or **VOLTAGE** control until the display reads **BAUD**; the active baud rate 1000 x the value visible in the **DC AMPERES** display (e.g., 38400 is displayed as 38.4). To change the baud rate, proceed to step 3.
3. Tap the **DC OUTPUT** switch. The baud rate visible in the **DC AMPERES** display begins blinking.
4. Rotate the **CURRENT** control to change the baud rate, then tap the **DC OUTPUT** switch to accept the displayed baud rate. The display briefly reads **DONE**, then returns to **BAUD**.
5. Rotate the **VOLTAGE** control until display reads **EXIT**, then tap the **DC OUTPUT** switch to exit

3.2.14 SETTING UP MASTER/SLAVE CONFIGURATIONS [STANDARD MODELS ONLY]

Both units of a master/slave pair must be identical models. After connecting the RS 232 ports (see PAR. 2.7.8), proceed as follows to configure the individual units. First configure the slave (see PAR 3.2.14.1), then the master (see PAR 3.2.14.2). Ensure adequate source power is available to support the requirements of both power supplies. Output wiring must be in accordance with PAR. 2.7.6 for series output connection or PAR. 2.7.7 for parallel output connection as applicable; parallel pairs must include load sharing connection per PAR. 2.7.7.1.

3.2.14.1 CONFIGURE POWER SUPPLY AS SLAVE [STANDARD MODELS ONLY]

1. Turn power on. If the unit comes up in setpoint mode (see PAR. 3.2.7), tap either the **CURRENT** or **VOLTAGE** control to take the unit out of setpoint mode (status display goes from **SET** to blank).
2. Using a thin tool (e.g., a paper clip), press the **FUNCTION** switch once, then rotate either the **CURRENT** or **VOLTAGE** control until the display reads **M/S**.
3. Tap the **DC OUTPUT** switch.
 - The status display reads either **SERI** (series) or **PARA** (parallel).
 - The **DC VOLTS** display shows the number assigned to the unit (1 = master, 2 or above = slave).

- The **DC AMPERES** display shows the maximum number of units in the configuration.
 - The factory default is standalone operation (**DC VOLTS** and **DC AMPERES** show 1).
4. To change the configuration tap the **DC OUTPUT** switch once. The **DC VOLTS** and **DC AMPERES** start blinking.
 - Specify either **SERI** (series configuration for higher voltage) or **PARA** (parallel configuration for higher current) using either the **VOLTAGE** or **CURRENT** control by *holding in* and rotating the control. Both connected units must be set the same, either **SERI** or **PARA**.
 - Specify the total number of units in the configuration to 2 by rotating the **CURRENT** control.
 - Specify the unit number to be assigned (2 = slave) by rotating the **VOLTAGE** control.
 5. Press **DC OUTPUT** to accept the displayed settings. The unit briefly flashes wait, then restarts with the new settings; press **FUNCTION** to abort without changing the settings.

NOTE: Until both units are configured properly, the displays will cycle as follows: status display will flash **E241** (hardware error), then **DC VOLTS**, status display and **DC AMPERES** flash **x OF y** where **x** = unit number and **y** = total number of units, the status display flashes the type of connection **SERI** (series) or **PARA** (parallel).

3.2.14.2 CONFIGURE POWER SUPPLY AS MASTER [STANDARD MODELS ONLY]

1. Turn power on. If the unit comes up in setpoint mode (see PAR. 3.2.7), tap either the **CURRENT** or **VOLTAGE** controls to take the unit out of setpoint mode (status display goes from **SET** to blank).
2. Using a thin tool (e.g., a paper clip), press the **FUNCTION** switch once, then rotate either the **CURRENT** or **VOLTAGE** control until the display reads **M/S**.
3. Tap the **DC OUTPUT** switch.
 - The status display reads either **SERI** (series) or **PARA** (parallel).
 - The **DC VOLTS** display shows the number assigned to the unit (1 = master, 2 or above = slave).
 - The **DC AMPERES** display shows the maximum number of units in the configuration.
 - The factory default is standalone operation (**DC VOLTS** and **DC AMPERES** show 1).
4. To change the configuration tap the **DC OUTPUT** switch once. The **DC VOLTS** and **DC AMPERES** start blinking.
 - Specify either **SERI** (series configuration for higher voltage) or **PARA** (parallel configuration for higher current) using either the **VOLTAGE** or **CURRENT** control by *holding in* and rotating the control. Both connected units must be set the same, either **SERI** or **PARA**.

- Specify the total number of units in the configuration to 2 by rotating the **CURRENT** control.
 - Specify the unit number to be assigned (1 = master) by rotating the **VOLTAGE** control.
5. Press **DC OUTPUT** to accept the displayed settings. The unit briefly flashes **WAIT**, then restarts with the new settings; press **FUNCTION** to abort without changing the settings.

NOTE: Until both units are configured properly, the displays will cycle as follows: status display will flash **E241** (hardware error), then **DC VOLTS**, status display and **DC AMPERES** flash **x OF y** where **x** = unit number and **y** = total number of units, the status display flashes the type of connection **SERI** (series) or **PARA** (parallel).

3.2.14.3 OPERATING THE MASTER/SLAVE CONFIGURATION [STANDARD MODELS ONLY]

NOTE: When starting a master/slave pair, the slave unit must be energized before the master unit.

Once the pair is energized, the master unit searches for the corresponding slave unit. Until communication is established the status displays of the two units will cycle as follows: status display will flash **E241** (hardware error), then **DC VOLTS**, status display and **DC AMPERES** flash **x OF y** where **x** = unit number and **y** = total number of units, the status display flashes the type of connection **SERI** (series) or **PARA** (parallel). When the slave is found, the status display of the slave reads **SLVE** and the **DC VOLTS** and **DC AMPERES** displays on the slave go blank. For the master/slave combination to work properly the number of slave units specified in the master (PAR. 3.2.14.2, step 4) must be found.

When the slave has been found, the master proceeds with the normal turn-on sequence and the unit proceeds to **SET** mode. The master front panel readouts show the total values for set point, voltage and current readback, virtual model (the virtual model and protection settings of the slave are automatically programmed to be the same as the master) and protection settings for the master/slave configuration. All controls on the slave are disabled. The parallel or series combination is controlled from the master using either the front panel, SCPI commands, or analog control.

- If analog control is used, only the master is configured for analog control (the slave is controlled digitally by the master).
- If Remote Inhibit is used, it should only be connected to the master.
- If **E241** (hardware error) is showing in the status display, check the master and/or slave setup. If necessary, use **FUNCTION** switch to enter the M/S menu to change the configuration as described above.
- If there is no communication between units for approximately 10 seconds, all units will turn off their output and the status display will flash **E241** (hardware error), then **xOFy** where **x** = unit number and **y** = total number of units, and finally the serial/parallel configuration setting **SERI** or **PARA**.
- Fault recovery mode (PAR. 3.2.17.3.2) for all faults is fixed as PROTECTED mode.

- Calibration cannot be performed on a master/slave pair; the individual units must be reconfigured back to independent mode (PAR 3.2.14.4) and then calibrated as individual units.
- Baud rate is automatically adjusted to highest supportable rate as part of master/slave setup and cannot be adjusted by user.
- LIST, VOLT:MODE TRANS and CURR:MODE TRANS commands are not supported for master/slave pairs.

3.2.14.4 RESTORING THE MASTER/SLAVE CONFIGURATION TO STANDALONE OPERATION [STANDARD MODELS ONLY]

First configure the master, then the slave for standalone operation.

1. If the units are in setpoint mode (see PAR. 3.2.7), tap either the **CURRENT** or **VOLTAGE** controls to take the units out of setpoint mode (status display goes from **SET** to blank).
2. Using a thin tool (e.g., a paper clip), press the **FUNCTION** switch of the unit to be restored to standalone operation, then rotate either the **CURRENT** or **VOLTAGE** control until the display reads **M/S**.
3. Tap the **DC OUTPUT** switch once.
 - The status display reads either **SERI** (series) or **PARA** (parallel).
 - The **DC VOLTS** display shows the number assigned to the unit (1 = master). The **DC AMPERES** display shows the maximum number of units in the configuration.
4. To change the configuration tap the **DC OUTPUT** switch once. The **DC VOLTS** and **DC AMPERES** start blinking.
 - Rotate the **CURRENT** control until **DC AMPERES** display shows 1.
 - Rotate the **VOLTAGE** control until **DC VOLTS** display shows 1.
5. Press **DC OUTPUT** to accept the displayed settings. The unit briefly flashes **WAIT**, then restarts with the new settings; press **FUNCTION** to abort without changing the settings.

NOTE: Once the master is configured for standalone operation, the slave status display will flash **E241** (hardware error).

6. Repeat steps 2 through 5 to restore the slave unit to standalone operation.

3.2.15 LAN INTERFACE CONFIGURATION [E-SERIES MODELS ONLY]

If the status display shows **SET**, tap either the **CURRENT** or **VOLTAGE** controls to take the unit out of setpoint mode (status display goes from **SET** to blank). Using a thin tool (e.g. end of paper clip), press **FUNCTION** switch once, then rotate either **VOLTAGE** or **CURRENT** control until status display reads **LAN**. Press **DC OUTPUT** switch to enter the LAN Interface configuration menu. Rotate either **VOLTAGE** or **CURRENT** control to see the available functions.

- **LRST** - LAN Reset. To restore the LAN interface configuration to the factory default, tap **DC OUTPUT** switch once, then rotate either **VOLTAGE** or **CURRENT** control to show **YES** in the **DC VOLTS** display, then tap **DC OUTPUT** switch again. The factory default settings listed in PAR. 3.3.1.3 are restored upon exiting the Function menu.

- **DHCP** - DHCP status is displayed in the **DC VOLTS** display. To change the setting press **DC OUTPUT** switch, then rotate either **VOLTAGE** or **CURRENT** control to see desired setting and press **DC OUTPUT** switch to save.
 - ON - The KLP requests an IP address from the DHCP server. (AUTOIP set to OFF.)
 - OFF - The KLP uses the IP, MASK, GATE and DNS addresses established by the user using either the UTIL - LAN menus at the front panel, the web interface (see PAR. 3.3.6) or via SCPI commands over one of the digital interfaces. (AUTO IP also set to OFF.)
- **AUTO** - AUTO IP status is displayed in the **DC VOLTS** display.
 - ON - The KLP obtains an IP address automatically. (Both DHCP and AUTO IP set to ON.)
 - OFF - The KLP uses the IP, MASK, GATE and DNS addresses established by the user using either the UTIL - LAN menus at the front panel or via SCPI commands. (AUTOIP set to OFF.)
- **MAC1** - Shows first pair of hex digits of the MAC address (e.g., for MAC address 01-23-45-67-89-AB the **DC VOLTS** display shows 01- and the **DC AMPERES** display shows 23-). Cannot be changed by the user.
- **MAC2** - Shows second of two hex digits of the MAC address (e.g., for MAC address 01-23-45-67-89-AB the **DC VOLTS** display shows 45- and the **DC AMPERES** display shows 67-). Cannot be changed by the user.
- **MAC3** - Shows third pair of hex digits of the MAC address (e.g., for MAC address 01-23-45-67-89-AB the **DC VOLTS** display shows 89- and the **DC AMPERES** display shows AB). Cannot be changed by the user.
- **IP1** - Shows first half of IP address (e.g., for IP address 192.168.000.200 the **DC VOLTS** display shows 192._ and the **DC AMPERES** display shows 168._). To change the address, press **DC OUTPUT** switch, then rotate **VOLTAGE** control to change 192._ or **CURRENT** control to change 168._, then press **DC OUTPUT** switch to save.
- **IP2** - Shows second half of IP address (e.g., for IP address 192.168.000.200 the **DC VOLTS** display shows _000. and the **DC AMPERES** display shows _200). To change the address, press **DC OUTPUT** switch, then rotate **VOLTAGE** control to change _000. or **CURRENT** control to change _200., then press **DC OUTPUT** switch to save.
- **MSK1** - Shows first half of SUBNET MASK address (see IP1 described above). Default is 255.255.
- **MSK2** - Shows second half of SUBNET MASK address (see IP2 described above). Default is 0.0
- **GTE1** - Shows first half of GATE address (see IP1 described above).
- **GTE2** - Shows second half of GATE address (see IP2 described above).
- **DNS1** - Shows first half of DNS address (see IP2 described above).
- **DNS2** - Shows second half of DNS address (see IP2 described above).
- **RTN** - Return to **LAN** menu.

3.2.16 UNIT CONFIGURATION

The Configuration Function identifies the firmware version, the KLP model, and the options installed.

1. If the status display shows **SET**, tap either the **CURRENT** or **VOLTAGE** controls to take the unit out of setpoint mode (status display goes from **SET** to blank).
2. Using a thin tool (e.g., a paper clip), press the **FUNCTION** switch once, then rotate either the **VOLTAGE** or **CURRENT** control until the status display reads **CNFG**.
3. Tap **DC OUTPUT** switch to enter the submenu, then rotate either the **VOLTAGE** or **CURRENT** control to view the following configuration information:
 - When the status display reads **VERS**, the **DC VOLTS** display identifies whether the firmware is the factory shipped firmware (**Pri** displayed) or field updated firmware (**SEC** displayed). The **DC AMPERES** display shows the firmware version. This information cannot be changed directly by the user.
 - When the status display reads **KLP**, the **DC VOLTS** display shows the model voltage rating (e.g, 75.00 for KLP 75-33) and the **DC AMPERES** display shows the model current rating (e.g, 33.34 for KLP 75-33). This information cannot be changed by the user.
 - If the status display reads **RODC**, this indicates the unit is an R-Option model that has RODC (Rapid Output Discharge Circuit) installed.
 - If the status display reads **LAN**, this indicates the unit is an E-Series model that has the the RS 232 port replaced by a LAN-compatible, ethernet-enabled LAN communication port.
 - When status display reads **RTN**, tap **DC OUTPUT** switch to exit submenu and return to previous menu

3.2.17 UTILITY FUNCTION

The Utility Function provides additional system information or access to special functions. These are described below.

1. If the status display shows **SET**, tap either the **CURRENT** or **VOLTAGE** controls to take the unit out of setpoint mode (status display goes from **SET** to blank)
2. Using a thin tool (e.g., a paper clip), press the **FUNCTION** switch once, then rotate either the **VOLTAGE** or **CURRENT** control in either direction until status display reads **UTIL**.
3. Tap **DC OUTPUT** switch once, then rotate either the **VOLTAGE** or **CURRENT** control in either direction to select the function identified in the status display (see below). Tap the **DC OUTPUT** switch to enter the submenu.
 - **RELY** - Relay Control (see PAR. 3.2.17.1)
 - **QkBT** - Quick Boot (see PAR. 3.2.17.2)
 - **ADJ** - Coarse/Fine Adjustment Preference (see PAR. 3.2.4)
 - **SYST** - System Configuration (see PAR. 3.2.17.3)

- **ANRB** - Analog Output Full Scale calibration voltages (see PAR. 3.2.17.4)
- **ANPR** - Analog Input Full Scale calibration voltages (see PAR. 3.2.17.5)
- **LBT** - [Standard models only] Loop Back Test used to isolate RS 232 communication problems (see KLP Developer's Guide).
- **CAL** - Display last calibration date and/or begin Calibration (see PAR. 3.2.17.6)
- **RTN** - Exit any submenu and return to previous menu

3.2.17.1 INTERNAL RELAY CONTROL

The internal relay contacts available at the Analog I/O connector can be configured from the front panel to operate in either Fault, Manual or List mode. If FAULT mode (the factory default) is selected, the relay energizes automatically upon detection of a user-selected condition. The default selection is **NORM** (normal), triggering the relay for any system fault (see PAR. 1.5.9). Two additional selections are available: a) **v->c**, adding a fault indication when the unit transitions from Constant Voltage (CV) to Constant Current (CC) mode; and b) **c->v**, adding a fault indication when the unit transitions from CC to CV mode. If **v->c** (or **c->v**) is selected, the amount of time the unit must be in CC (or CV) mode before the relay energizes may be programmed from the front panel (see step 2a) or via the CONFIGURE INSTRUMENT web page (E-series models only).

1. Enter **UTIL** menu (see PAR. 3.2.17, steps 1 through 3) and rotate either **VOLTAGE** or **CURRENT** control until status display reads **RELY**. The **DC VOLTS** display indicates whether the relay is currently **ON** (energized) or **OFF** (deenergized). Tap **DC OUTPUT** switch to enter Relay Control menu.

- Rotate either **VOLTAGE** or **CURRENT** control to see the available relay control modes in the status display. The modes are:

FLT (factory default) - Relay is set to energize automatically upon detection of one of three preselected conditions (tap **DC OUTPUT** to access FLT submenu):

NORM: (factory default) relay energizes immediately upon detection of a system error:

v->c: relay energizes immediately upon detection of a system error and, after a user-programmable delay, the relay energizes upon a transition from constant voltage (CV) to constant current (CC) mode. Error code -302 is added to the error queue and E302 is displayed on the front panel Status Display.

c->v: relay energizes immediately upon detection of a system error and, after a user-programmable delay, the relay energizes upon a transition from constant current (CC) to constant voltage (CV) mode. Error code -302 is added to the error queue and E302 is displayed on the front panel Status Display.

RTN: Return to **FLT** menu.

MAN - Relay on/off is controlled manually, directly from the front panel (see below). Relay state is not retained; relay will be off when unit is turned on

LIST - Relay on/off is controlled remotely using LIST commands via GPIB or RS 232 interface (see KLP Developer's Guide).

RTN - Return to **RELY** menu.

2. To select mode rotate either **VOLTAGE** or **CURRENT** control until status display reads **FLT** (factory), **MAN** (manual), or **LIST**. Then press **DC OUTPUT** switch to save selection.

a. If **FLT** is selected, rotate **VOLTAGE** or **CURRENT** control to select **NORM**, **V->C**, or **C->V**. in the status display.

(1) To select **NORM**, tap the **DC OUTPUT** switch to save selection; unit returns to **RELY** menu.

(2) To select **V->C** or **C->V**, first set the delay. While **V->C** or **C->V** is in the status display, the **DC AMPERES** display shows the delay in seconds, from 000.5 to 128.0: **NNND**, where **NNN** is an integer from 0 to 128 and **D** will be either .0 or .5 (000.0 is not permitted). The delay determines the length of time that the unit must be operating in the new mode before energizing the relay.

The factory default delay time is set to 1.0 seconds to prevent false tripping of the relay during application of output power to low impedance or highly reactive loads. If false tripping occurs, this delay may be increased as needed.

To change the delay, press in and rotate either the **VOLTAGE** or **CURRENT** control; release the control when the **DC AMPERES** display shows the desired delay. Tap the **DC OUTPUT** switch to save selection; unit returns to **RELY** menu.

NOTE: Once the relay turns on in **V->C** or **C->V** mode, the relay will go off again when the unit transitions back to the original mode, or when the output is turned off.

b. To select **MAN**, tap the **DC OUTPUT** switch to save selection. The **DC VOLTS** display flashes the present relay state: **ON** or **OFF**. To change the state of the relay rotate either **VOLTAGE** or **CURRENT** control until the desired relay state is displayed, then tap the **DC OUTPUT** switch to immediately set the relay to the selected state and return to the **RELY** menu.

c. To select **LIST**, tap the **DC OUTPUT** switch to save selection; unit returns to the **RELY** menu

3. Rotate either **VOLTAGE** or **CURRENT** control until status display shows **RTN** and press **DC OUTPUT** switch to exit **UTIL** menu, then rotate either **VOLTAGE** or **CURRENT** control until status display shows **EXIT** and press **DC OUTPUT** switch to exit **FUNCTION** control.

NOTE: If a **SYSTEM:SECURITY:IMMEDIATE** command is issued, the above relay control settings are reset to the factory default: **FLT - NORM**.

3.2.17.2 QUICK BOOT

Enter **UTIL** menu (see PAR. 3.2.17, steps 1 through 3) and rotate either **VOLTAGE** or **CURRENT** control until status display reads **QKBT** - Quick Boot. If Quick boot is ON, then the next time the unit is powered up it will go directly to setpoint mode (status display reads **SET**, see PAR. 3.2.10) without displaying **MODL**, **VIRT**, and **PROT** settings.

- The **DC VOLTS** display indicates whether quick boot is **ON** or **OFF**.

1. Tap the **DC OUTPUT** switch to change the setting. The **DC VOLTS** display begins to blink.

2. Rotate either **VOLTAGE** or **CURRENT** control until the desired quick boot state is displayed, then tap the **DC OUTPUT** switch to save the setting; the blinking stops.
3. To exit, rotate either **VOLTAGE** or **CURRENT** control until the status display reads **RTN**, then tap the **DC OUTPUT** switch. To exit the **UTIL** menu rotate either **VOLTAGE** or **CURRENT** control until the status display reads **EXIT**, then tap the **DC OUTPUT** switch.

3.2.17.3 SYSTEM CONFIGURATION FUNCTIONS

The system configuration functions allow the user to determine 1) whether the Remote Inhibit signal is an active TTL high or low and 2) how the unit recovers from a fault. The unit password (see PAR. 3.2.8) is required to change these functions.

1. Enter **UTIL** menu (see PAR. 3.2.17, steps 1 through 3) and rotate either **VOLTAGE** or **CURRENT** control until status display reads **SYST**.
2. Tap the **DC OUTPUT** switch to enter the System Configuration Functions menu.

3.2.17.3.1 REMOTE INHIBIT POLARITY

The Remote Inhibit signal REM_INH is applied to analog I/O port, pin 8 (see PAR's. 2.7.9 and 3.2.6). This signal can be configured to be active (inhibit the output) for either a TTL high or low.

1. Enter **UTIL** menu (see PAR. 3.2.17, steps 1 through 3) and rotate either **VOLTAGE** or **CURRENT** control until status display reads **SYST**, then tap **DC OUTPUT** switch. Rotate either **VOLTAGE** or **CURRENT** control until the status display reads **rINH** and the **DC VOLTS** display reads either **Hi** or **Lo**.
2. To change the remote inhibit setting, tap the **DC OUTPUT** switch. The status display shows **PASS**. Enter the unit password (see PAR. 3.2.8) and tap **DC OUTPUT** switch to accept the number. When the password is accepted, the status display reads **rINH** and **DC VOLTS** display is blinking.
3. Rotate either **VOLTAGE** or **CURRENT** control until **DC VOLTS** display reads desired setting, then tap **DC OUTPUT** switch to accept.
4. Tap **FUNCTION** switch to exit or rotate **VOLTAGE** or **CURRENT** control until status display reads **RTN**, then tap **DC OUTPUT** switch to return to next highest menu.

3.2.17.3.2 FAULT RECOVERY MODE

The KLP allows the user to control how the unit recovers from faults, and allows different responses for different faults. This function is password-protected (see PAR. 3.2.8). The three recovery options are PROT, SAFE and AUTO (see Table 3-2).

- **PROTECTED** - When a fault configured as PROT is detected, the output is disabled. Recovery requires that the user turn the unit off and wait five seconds before turning the unit on. After initializing, the output is disabled and the unit is in Setpoint mode, programmed to minimum values for voltage and current. This is the safest recovery option, forcing the operator to reboot the power supply before programming and re-enabling the output, hopefully after eliminating the cause of the fault. PROT is the factory default setting for all fault recoveries. **NOTE:** If the source power failure (PWR) recovery mode is selected as AUTO, refer to "WARNING" on page 3-20 listed under AUTO description.

- **SAFE** - When a fault configured as **SAFE** is detected, the output is disabled and the unit is returned to Setpoint mode, programmed to last settings (retrieved from the setpoint registers) for voltage and current. Recovery requires that the user exit Setpoint mode and re-enable the output, either from the front panel or via one of the digital programming ports. Recovery cannot be initiated by toggling the remote inhibit line at the analog programming port. This option provides greater operator convenience by eliminating the need to reboot the power supply while preserving a safe response (output off), but it is the user's responsibility to **NOT** attempt multiple consecutive restarts without eliminating the fault condition.
- **AUTOMATIC** - When a fault configured for **AUTO** recovery is detected, the output is disabled as long as the fault condition exists. Once the fault condition is no longer present (e.g., the unit has cooled down after an overtemperature fault) the output is enabled at the last actual settings for voltage and current, as opposed to setpoints (see PAR. 3.2.10.3 for Last Setting Recall). To alert the user to this risk, if any fault is set to **AUTO** recovery, the status display briefly shows **AUTO** after a) any fault recovery, b) any output enable action or c) upon leaving Setpoint mode. In addition, if **AUTO** recovery is selected for source power failure (**PWR**) faults, the status display flashes **AUTO** for one second as part of the power-up sequence.



WARNING

When AUTOMATIC recovery is selected, upon removal of the fault condition the output recovers to the conditions (programmed voltage/current levels and output enabled/disabled) that existed when the fault was detected. For this reason, AUTOMATIC recovery mode is best suited to applications where it is anticipated that the output is always enabled. For safety reasons, when servicing circuits powered by the output always switch the KLP front panel circuit breaker OFF or activate Remote Inhibit (see PAR. 3.2.6).

If more than one fault occurs, the fault with the lowest risk level determines the unit's response, however multiple faults will cause the output to be off upon recovery, even if set to **AUTO**.

The factory default configuration is **PROTECT** for all faults. Note that some faults have limited options. The recovery options for each fault are presented in Table 3-2:

TABLE 3-2. FAULT RECOVERY CONFIGURATION

Fault	Auto Recovery Options		
	PROTECT	SAFE	AUTO
OVP (Overvoltage Protection fault)	YES	YES	---
OCP (Overcurrent Protection fault)	YES	YES	---
OLF (Output Lead Fault)	YES	YES	---
TEMP (Temperature fault)	YES	YES	YES
PWR (Loss of source power fault)	YES	YES	YES
FAN (Fan failure fault)	YES (not configurable)	---	---

NOTE: When using a master/slave configuration, all faults are set to **PROTECT** and power to both units must be cycled to clear a fault.

1. Enter **UTIL** menu (see PAR. 3.2.17, steps 1 through 3) and rotate either **VOLTAGE** or **CURRENT** control until status display reads **SYST**, then tap **DC OUTPUT** switch. Rotate either **VOLTAGE** or **CURRENT** control to until the status display reads **RCOV**.

The **DC VOLTS** and **DC AMPERES** displays show a series of bars that give a snapshot picture of the recovery configuration as defined in Figure 3-2. The location of the bar (top, middle, or bottom) corresponds to the risk level (high for **AUTO**, middle for **SAFE**, and low for **PROTECT**). The character positions are assigned to the configurable faults as shown.

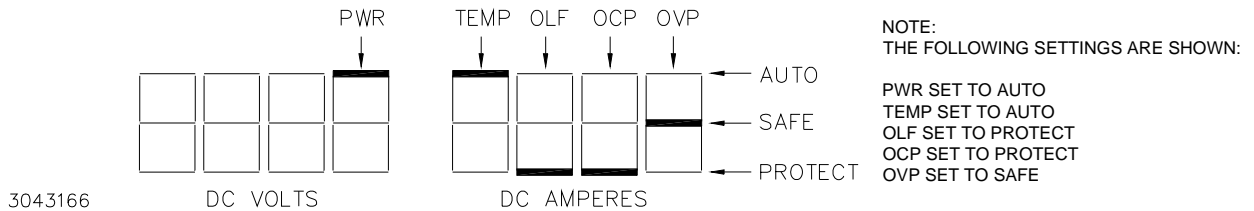

FIGURE 3-2. FAULT RECOVERY CONFIGURATION DISPLAY

2. To change a fault recovery setting, tap the **DC OUTPUT** switch to enter the Recovery menu.
3. The status display shows **PASS**. Enter the unit password (see PAR. 3.2.8) and tap **DC OUTPUT** switch to accept the number. When the password is accepted, status display reads **OVP** and the **DC VOLTS** display shows the present fault recovery status (**PROT** or **SAFE**) for **OVP**. Rotate either **VOLTAGE** or **CURRENT** control to cycle through **OVP**, **OCP**, **OLF**, **TEMP**, and **PWR** settings. To exit tap the **DC OUTPUT** switch while the status display shows **RTN**.
4. To change a setting, tap the **DC OUTPUT** switch while the status display shows the fault. The setting in the **DC VOLTS** display begins to blink. Rotate either **VOLTAGE** or **CURRENT** control to cycle through the allowable settings. Tap the **DC OUTPUT** switch to accept the setting shown in the **DC VOLTS** display.
5. To continue, rotate either **VOLTAGE** or **CURRENT** control to select another fault. To exit, either select **RTN** and tap the **DC OUTPUT** switch to go to the next highest menu, or tap the **FUNCTION** switch to exit function mode.

3.2.17.4 ANALOG OUTPUT FULL SCALE CALIBRATION

Enter **UTIL** menu (see PAR. 3.2.17, steps 1 through 3) and rotate either **VOLTAGE** or **CURRENT** control until status display reads **ANRB**.

- The **DC VOLTS** display shows the full scale analog readback voltage value produced by the full scale output voltage as established by the limit model.
 - The **DC AMPS** display shows the full scale analog readback voltage value produced by the full scale output current as established by the limit model.
1. To change the settings tap the **DC OUTPUT** switch. Note that **DC VOLTS** and **DC AMPERES** displays begin blinking.
 2. Rotate **VOLTAGE** control to set the analog readback voltage value desired for full scale output voltage.
 3. Rotate the **CURRENT** control to set the analog readback voltage value desired for full scale output current.

4. Tap the **DC OUTPUT** switch to accept the new settings (blinking stops) or use a thin tool (e.g., a paper clip) to press the **FUNCTION** switch to cancel the operation.
5. To exit, rotate either **VOLTAGE** or **CURRENT** control until the status display reads **RTN**, then tap the **DC OUTPUT** switch. To exit the **UTIL** menu rotate either **VOLTAGE** or **CURRENT** control until the status display reads **EXIT**, then tap the **DC OUTPUT** switch.

3.2.17.5 ANALOG INPUT FULL SCALE CALIBRATION

Enter **UTIL** menu (see PAR. 3.2.17, steps 1 through 3) and rotate either **VOLTAGE** or **CURRENT** control until status display reads **ANPR**.

- The **DC VOLTS** display shows the analog input voltage value that produces the full scale output voltage established by the virtual model.
 - The **DC AMPS** display shows the analog input voltage value that produces the full scale output current established by the virtual model.
1. To change the settings tap the **DC OUTPUT** switch. Note that **DC VOLTS** and **DC AMPERES** displays begin blinking.
 2. Rotate **VOLTAGE** control to set the analog voltage value required to produce the full scale output voltage.
 3. Rotate the **CURRENT** control to set the analog voltage value required to produce the full scale output current.
 4. Tap the **DC OUTPUT** switch to accept the new settings (blinking stops) or use a thin tool (e.g., a paper clip) to press the **FUNCTION** switch to cancel the operation.
 5. To exit, rotate either **VOLTAGE** or **CURRENT** control until the status display reads **RTN**, then tap the **DC OUTPUT** switch. To exit the **UTIL** menu rotate either **VOLTAGE** or **CURRENT** control until the status display reads **EXIT**, then tap the **DC OUTPUT** switch.

3.2.17.6 CALIBRATION

Refer to PAR 4.3.

3.3 REMOTE MODE PROGRAMMING USING DIGITAL INTERFACES

For digital remote programming refer to the KLP Developer's Guide.

3.3.1 FACTORY DEFAULT SETTINGS

3.3.1.1 GPIB FACTORY DEFAULTS

The factory default GPIB address is 6; refer to PAR. 3.2.12 to change the GPIB address.

3.3.1.2 RS 232 FACTORY DEFAULTS [STANDARD MODELS ONLY]

The factory default RS 232 settings are as follows; refer to PAR. 3.2.13 to change the RS 232 baud rate (standard models only):

- Baud rate: 38400
- Parity: None
- Data Bits 8
- Stop Bits 1
- Echo OFF
- XON ON (enabled) NOTE: Kepeco strongly recommends the XON XOFF method for data transfer via RS 232 protocol for all Kepeco products. If this method is not selected, it is the user's responsibility to ensure completion of any response by the power supply prior to issuance of subsequent commands.

3.3.1.3 LAN FACTORY DEFAULTS [E-SERIES MODELS ONLY]

The factory default LAN interface settings are listed below, however, actual unit settings may differ from those shown below depending upon whether the LAN is active (or connected).

- DHCP: ON
- AUTOIP: ON
- PING: ON (can only be changed through web interface)
- IP Address: Undefined
- MASK Address: 255.255.0.0
- GATE Address: 0.0.0.0
- DNS Address: 0.0.0.0

These default setting can be restored using the LAN Reset function (front panel only) or configured as desired from either the front panel (see PAR. 3.2.15) or the web interface (see PAR. 3.3.6.4).

If the LAN connection is active when the reset is sent, the default values are as shown, except that IP, MASK, GATE and DNS addresses are retrieved from the LAN or router and may differ from values shown

If the LAN is inactive (i.e. LAN cable unplugged, router inactive, etc.), DHCP and AUTOIP are disabled and IP, MASK, GATE and DNS addresses are all set to 0.0.0.0. If either the AUTOIP or DHCP function is enabled by the user when the LAN inactive, it will be disabled if source power is cycled.

3.3.2 ADDITIONAL FUNCTIONS NOT AVAILABLE FROM THE FRONT PANEL

Some additional functions are described in the KLP Developer's Guide that are not available from the front panel:

- Storage of User-programmed Active Settings - 40 memory locations are available to store and recall active settings of the power supply. The active setting include voltage, current, protection limits, and output state (ON or OFF) This feature may be also accessed using the web interface (E-Series models only, see PAR. 3.3.6.6.3).
- User-determined output Sequences - Up to 100 memory locations are available for programming the KLP output using multiple command sequences that can be initiated by a single LIST command (see KLP Developer's Guide). This feature may be also accessed using the web interface (E-Series models only, see PAR. 3.3.6.6.5).
- External Triggering - If external trigger mode is selected, grounding the EXT_TRG line (J2 pin 14 to pin 9, 11, 13 or 15) allows SCPI commands to change the output of the power supply. Refer to the KLP Developer's Guide for details on the use of triggering.

Kepeco provides three instrument drivers, IVI-COM, LabView G and VXI *plug&play* which simplify programming of the KLP power supply via the digital interfaces. These drivers are described in the KLP Developer's Guide and can be downloaded from the Kepeco web site at: <http://www.kepecopower.com/drivers/>

3.3.3 REMOTE PROGRAMMING USING THE IVI-COM INSTRUMENT DRIVER

The IVI-COM driver for KLP is available for download at www.kepecopower.com/drivers. Examples are provided in the KLP Developer's Guide.

3.3.4 REMOTE PROGRAMMING USING THE LABVIEW G INSTRUMENT DRIVER

The LabView G driver for KLP, available for download at www.kepecopower.com/drivers, includes a LabView G demonstration program that greatly simplifies programming the unit with a Windows™ compatible computer. After running a setup, a "soft" front panel is visible on the computer monitor that allows all the functionality of the local front panel. The LabView G soft front panel controls are explained in the KLP Developer's Guide.

3.3.5 REMOTE PROGRAMMING USING THE VXI *plug&play* INSTRUMENT DRIVER

The VXI *plug&play* driver for KLP, available for download at www.kepecopower.com, includes a demonstration program that greatly simplifies programming the unit via the GPIB or RS 232 ports with a Windows™ compatible computer. After running a setup, a "soft" front panel is visible on the computer monitor that allows all the functionality of the local front panel. The VXI *plug&play* soft front panel controls are explained in the KLP Developer's Guide.

3.3.6 REMOTE PROGRAMMING USING THE WEB INTERFACE [E-SERIES MODELS ONLY]

Remote programming of the KLP via the LAN port can be accomplished using a standard web browser connected to the internet. The factory default LAN settings of the KLP are DHCP on, AUTOIP on. When source power is applied to the power supply (e.g., circuit breaker switched on), it first tries to find a DHCP server and get an IP address; during this time the LAN indicator continues to blink. If a server is found and an address assigned, the LAN indicator stays on without blinking.

If the server is not found after approximately 10 seconds, or if DHCP has been disabled, the unit will use AUTOIP to get an address; if an IP address is found, the LAN indicator stays on without

blinking. The range of valid AUTOIP addresses is 169.254.000.000 through 169.254.255.255 inclusive. Note that the Network Mask default for AUTOIP is 255.255.000.000. If an IP address is not found after two seconds, the LAN indicator stays off.

The FUNCTION/LAN menu (see PAR. 3.2.15) can be used to view the IP address that was found, or change it if desired. The user can also elect to disable both DHCP and AUTOIP functions and enter IP, Network Mask, Gateway and DNS addresses manually.

3.3.6.1 TROUBLESHOOTING LAN COMMUNICATION PROBLEMS.

If the LAN indicator stays off:

- First verify that the host end of the LAN connection is active (switch or hub is powered on). These devices typically include indicators that indicate port activity, so if the port to which the power supply is connected is inactive (dark), try connecting to a different port.
- Inspect the LAN cable connections at both ends, ensuring that the plugs are fully engaged with their respective receptacles. Try replacing the LAN cable with a cable known to be good.
- If the KLP is connected directly to the computer's LAN port rather than through a switch hub or router, the connection must be made using a **null modem (crossover) cable** that reverses the transmit and receive pairs. **NOTE: The KLP LAN input will not do this swap automatically.**

If the LAN indicator is on without blinking, but communication problems persist:

- The cause may be a fixed address on the PC that is incompatible with the AUTOIP range (169.254.xxx.xxx) of the KLP. Refer to PAR. 3.2.15 to change IP1 and IP2 and assign a fixed IP address to the KLP in which the first three groups are identical to those of your PC's IP address.
- Refer to PAR 3.3.6.3 for browser types and versions supported and settings required.
- There can be latent delays in establishing communication between various devices on the LAN network hub, especially when the devices are powered on asynchronously. As a result, a steady LAN indication may begin blinking again when another device or the host computer itself is subsequently powered on. While this is a normal occurrence that typically resolves itself within a few seconds, LAN communication is interrupted during that time. Should this occur, first activate all devices connected to the hub and wait until the KLP LAN indicator is on steadily for several seconds before attempting to communicate with the KLP.

3.3.6.2 FINDING KEPCO POWER SUPPLIES ON THE LAN [E-SERIES MODELS ONLY]

The PSfind utility can be downloaded from the Kepco web site at www.kepcopower.com/drivers/drivers-dl3.htm#klp. This utility finds all operational Kepco power supplies connected to the LAN and then shows the MAC and IP addresses of the models found. To run the utility from your PC download the psfind.zip file to your computer. Extract psfind.exe from the zip file to a location of your choice, then double-click psfind.exe to run the application. A separate window opens as shown on Figure 3-3.

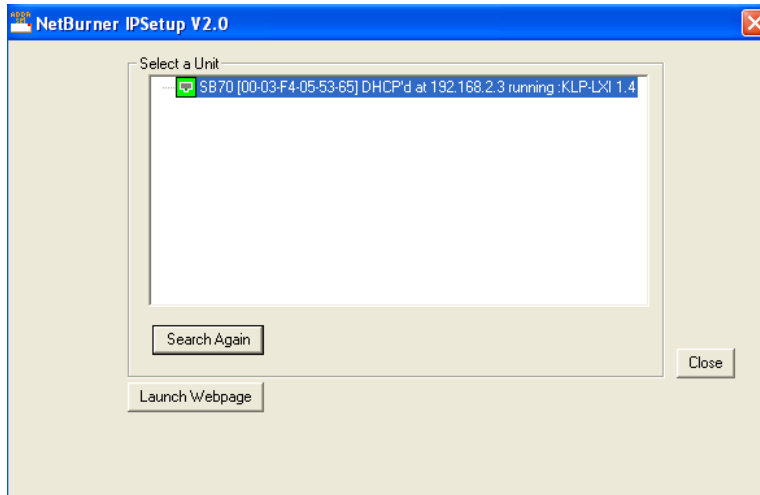

FIGURE 3-3. PS FIND SCREEN

Once the search is completed, all found units are displayed in the Select a Unit window (the MAC address appears in parentheses). If you do not see your device in the Select a Unit window or if the icon to the left of the selected instrument is red (not green), make sure it is turned on and connected to the network, then click the Search Again button.

3.3.6.3 LAUNCH WEB INTERFACE [E-SERIES MODELS ONLY]

After running the PSfind utility and selecting the desired unit (see PAR. 3.3.6.2), click the Launch Webpage button to open the KLP Instrument HOME PAGE (UNIT DESCRIPTION) in your default browser (see Figure 3-4). You can also launch the web page in any browser by entering the IP address as the URL.

NOTE: If source power to the KLP is removed or lost while a browser window is open, communication with the KLP can not be restored until the present browser window is closed and a new window is opened.

Upon initial display of the web page, it is good practice to click the browser Refresh/Reload button once to ensure that the power supply information displayed is up to date, and not prior information recalled from the browser cache.

Although most current browsers will work, Kepco recommends the following as fully supported: IE 5.5 and higher, Netscape 6 and higher and Firefox 1.0 and higher. Popup blocking must be disabled and Javascript must be enabled for proper operation. If popup blocking is enabled, it may prevent viewing of the help screens.

The KLP Instrument Home page identifies the unit which has been accessed, including Manufacturer, Instrument, Description, Serial Number, Calibration Date, Hostname, MAC Address and TCP/IP Address. Click the HELP box at the left of the screen for detailed explanations of each. These parameters can not be changed by the user. Fault alerts are not available from this page.

Clicking the ID INSTRUMENT box at the left of the screen, causes the physical front panel LAN indicator on the selected unit to blink, allowing visual confirmation as to which unit is selected. This is especially important if more than one unit is found on the LAN.

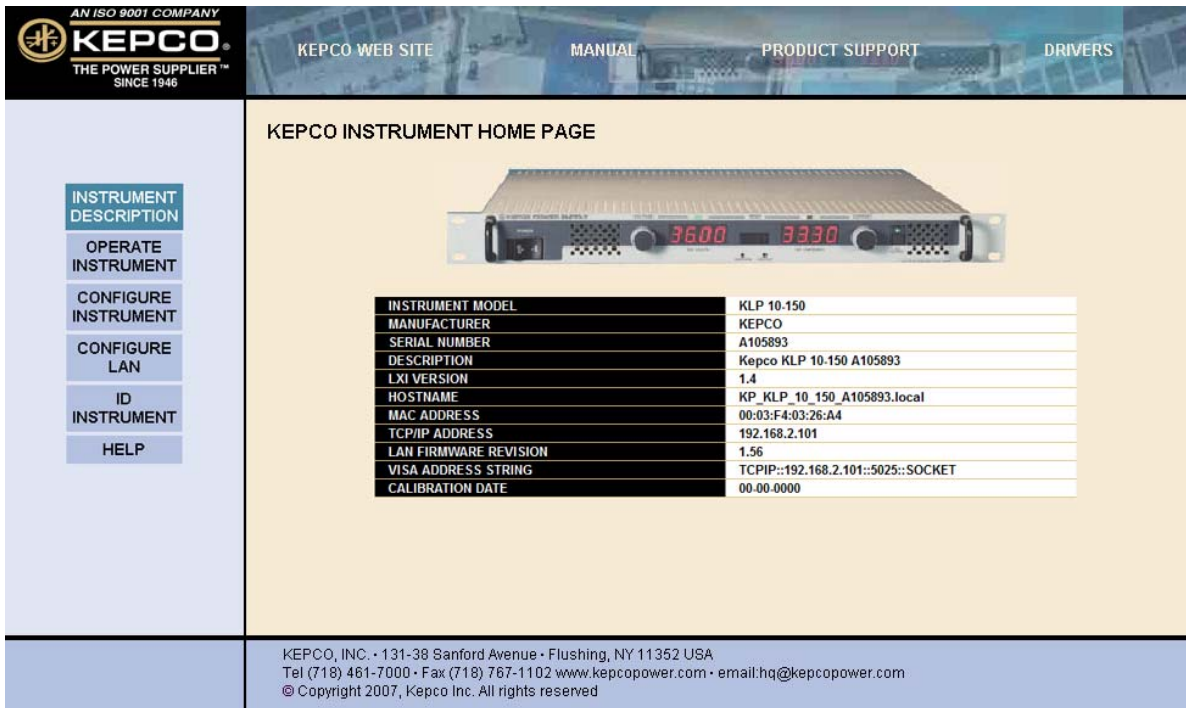

FIGURE 3-4. WEB INTERFACE HOME PAGE (UNIT DESCRIPTION)

3.3.6.4 INSTRUMENT CONFIGURATION USING WEB INTERFACE [E-SERIES MODELS ONLY]

Click on CONFIGURE INSTRUMENT at the left to view the INSTRUMENT Configuration page (Figure 3-5). The parameters that can be configured from this page are arranged in two groups.

The top group requires the unit password (see PAR. 3.2.8) to change the parameter and includes:

- Whether the polarity of the Remote Inhibit signal is active (inhibit) for low or high (see PAR. 3.2.17.3.1 for details).
- How the unit recovers from faults (see PAR. 3.2.17.3.2 for details).

The KLP evaluates only the first four characters of the entered password and discards any extra characters provided.

The second group does not require a password, and includes

- GPIB address (see PAR. 3.2.12 for details).
- Quick boot (see PAR. 3.2.17.2 for details).
- Assignment of the internal relay (see PAR. 3.2.17.1 for details). NOTE: The MODE CHANGE DELAY field **must** contain a non-zero value within the specified range regardless of the relay mode selected.
- If the relay is assigned to Manual, the state of the relay (ON or OFF) cannot be controlled via remote commands. The user must temporarily exit remote digital control (see

PAR. 3.2.2) and set the relay state using local controls (see PAR. 3.2.17.1, Item 2); refreshing the browser page will return the KLP to remote digital control.

Once the configuration has been altered by changing the applicable fields, click SUBMIT to save the new configuration, or NO CHANGE to clear and reload the page without saving (NO CHANGE is the same as browser refresh or reload).

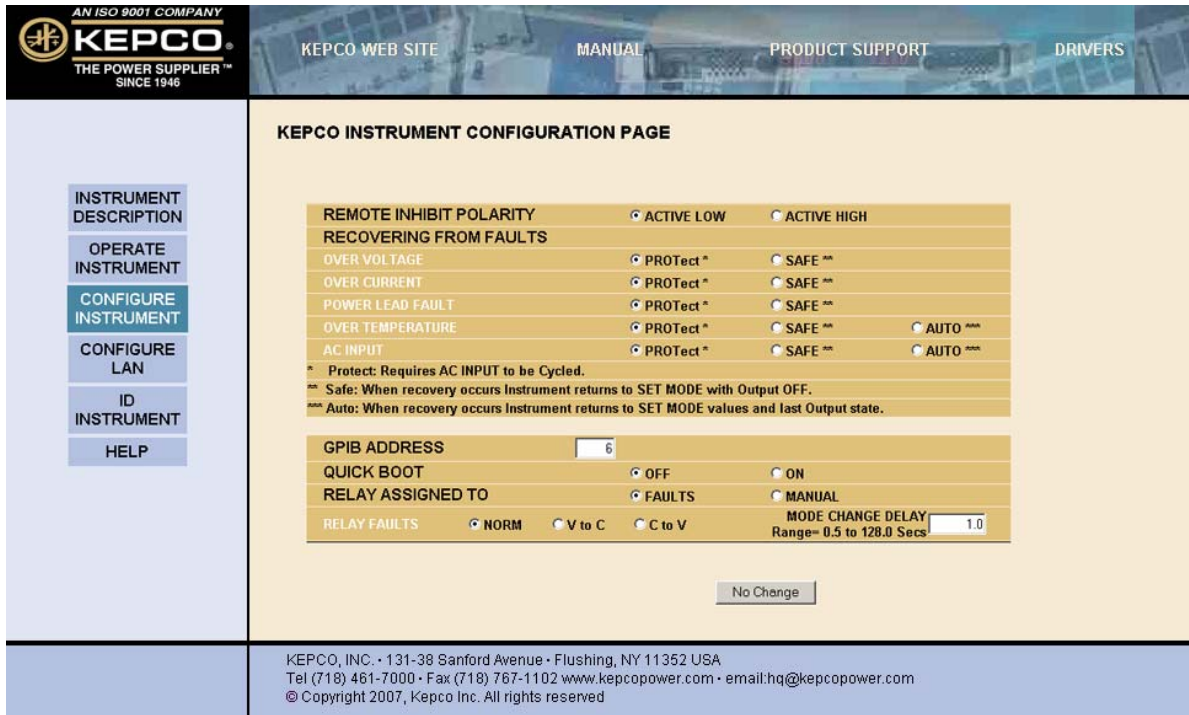

FIGURE 3-5. WEB INTERFACE CONFIGURE INSTRUMENT PAGE

3.3.6.5 LAN CONFIGURATION USING WEB INTERFACE [E-SERIES MODELS ONLY]

Click on CONFIGURE LAN at the left to view the LAN Configuration page (Figure 3-6). The parameters that can be configured from this page are Host Name (DHCP), Description, IP Address, Subnet Mask address, Default Gateway Address, and DNS Server Address. Separate checkboxes allow enabling of DHCP, AUTOIP and PING. Descriptions of these terms can be viewed by clicking the HELP box at the left. If a data entry fault condition exists, an alert window indicates the type of fault. Click OK to close the window; the SUBMIT button is disabled until the fault is corrected.

There are three passwords shown on this page which control access to the web pages only (not to be confused with the unit password (see PAR. 3.2.8) which is needed for calibration, changing virtual model, etc.). All passwords are four characters long only. The KLP evaluates only the first four characters and discards any extra characters provided. The CONFIGURE INSTRUMENT password is limited to numeric values only. The other passwords accept both upper and lower case information.

The OPERATE INSTRUMENT and CONFIGURE LAN web passwords described below are case sensitive.

NOTE: In cases where multiple users are expected to have access to the units, it is recommended that password access be used to restrict *control* of the unit to one user (functioning as a bus controller), while allowing other users viewing access. Allowing multiple users to issue commands to a single unit can cause unpredictable results and may cause the unit to lock up.

- The OPERATE INSTRUMENT password restricts the ability to modify the OPERATE INSTRUMENT page settings. Default is blank. The settings can still be viewed while password protected
- The CONFIGURE INSTRUMENT password restricts the ability to change some INSTRUMENT configuration parameters shown on the CONFIGURE INSTRUMENT page. Default is same as unit password (see PAR. 3.2.8).
- The CONFIGURE LAN password restricts the ability to change the LAN configuration parameters shown on the CONFIGURE LAN page (Figure 3-6). Default is blank.

KEPCO LAN CONFIGURATION PAGE

HOST NAME (DHCP)	KLP0	
DESCRIPTION	KLP 1200 Watt Series (0)	
IP ADDRESS	192.168.1.210	<input type="checkbox"/> DHCP ENABLED
SUBNET MASK	255.255.9.10	<input type="checkbox"/> AUTOIP ENABLED
DEFAULT GATEWAY	0.0.0.0	<input checked="" type="checkbox"/> PING ENABLED
DNS SERVER	0.0.0.0	

CHANGE PASSWORD	CURRENT	NEW	REPEAT
OPERATE INSTRUMENT			
CONFIGURE INSTRUMENT			
CONFIGURE LAN			

Submit No Change

KEPCO, INC. • 131-38 Sanford Avenue • Flushing, NY 11352 USA
 Tel (718) 461-7000 • Fax (718) 767-1102 www.kepcopower.com • email:hq@kepcopower.com
 © Copyright 2007, Kepco Inc. All rights reserved

FIGURE 3-6. WEB INTERFACE CONFIGURE LAN PAGE

To set a password for the first time, leave the CURRENT field blank, enter the new password in the NEW and REPEAT fields, then click SUBMIT. Subsequent changes require the current password to be entered in the CURRENT field. If a password is lost or forgotten, the factory default state (no password required) can be restored from the front panel using the LAN Reset function (see PAR. 3.2.15).

To change a parameter, enter the correct data and/or click the appropriate checkboxes, then click SUBMIT to save the change or NO CHANGE to clear and reload the page without saving. If the data is not entered within 20 seconds after the last keystroke, the data will revert to the

previous value. If the LAN CONFIGURATION password was set, you will be prompted to enter the password before the changes are accepted.

When SUBMIT is clicked after new IP address information is entered, the front panel LAN indicator blinks rapidly while the unit validates the IP address. If the address is valid, the browser returns to the INSTRUMENT DESCRIPTION page. If the address entered is already in use, the following note appears towards the top of the page:

NOTE: IP Address is in use.
Click CONFIGURE LAN and choose another IP to correct.

An IP address that is not already in use must be entered and submitted, otherwise the browser will lock, requiring the browser to be closed and reopened.

3.3.6.6 OPERATING THE UNIT USING WEB INTERFACE [E-SERIES MODELS ONLY]

To operate the unit, click the OPERATE INSTRUMENT box at the left. A simulated front panel at the top of the screen shows 1) output voltage and current, 2) CV or CC if the unit is in constant voltage or constant current mode, respectively (** is displayed if the output is off, meaning the unit is in neither CV nor CC mode), and 3) whether the output is on or off. An ON/OFF button can be clicked to turn the output on or off. A small white dot below the voltage display flashes to indicate the web page is communicating with the unit. If a fault condition exists, an alert window indicates the type of fault, and operation via the web is disabled. When the fault is corrected, click OK to close the alert window and resume operation via the web.

NOTE: If the OPERATE INSTRUMENT password has been set (see PAR. 3.3.6.5), you will be prompted to enter the password before the OPERATE INSTRUMENT page settings can be changed.

If the unit has been set to Analog control mode, the OPERATE INSTRUMENT page displays only voltage, current, CV or CC mode, and output state. The unit can not be controlled via the LAN interface and the message "Analog Remote Control" is displayed on the open web page.

The functions that the user can modify are listed on the black menu bar below the representation of the front panel: Output, Protection, Save/Recall, Reset, List, and Virtual Model, and are described in the following paragraphs.

NOTE: Once data in a field has been changed, clicking the browser's BACK button will cause all fields to revert to their previous values.

3.3.6.6.1 CHANGING THE OUTPUT [E-SERIES MODELS ONLY]

The Output dialog box opens when the OPERATE INSTRUMENT page is first opened, or when **OUTPUT** is clicked (see Figure 3-7). To set output voltage or current, enter the values and click SET. Voltage and current settings are not allowed to exceed either a) the virtual model setting or b) 83.3% of the protection value. Attempts to set voltage or current beyond these limits will not be accepted. To turn the output on or off, click the ON/OFF button within the simulated front panel.

3.3.6.6.2 CHANGING PROTECTION [E-SERIES MODELS ONLY]

Click **PROTECTION** to open the Protection dialog box (Figure 3-8). To set the overvoltage and overcurrent protection values, enter the values and click **Set**. See PAR. 3.2.11 for details about how overvoltage and overcurrent protection function in the KLP power supply.

3.3.6.6.3 USING SAVE AND RECALL [E-SERIES MODELS ONLY]

The KLP Power Supply contains 40 memory locations that can be used to store either active settings or a set of user-determined settings. Values are stored in the nonvolatile memory and are retained when the unit is turned off. The stored settings can then be recalled using this feature. These settings are cleared when a calibration is performed. Click **SAVE/RECALL** to open the Save/Recall Dialog Box (Figure 3-9).

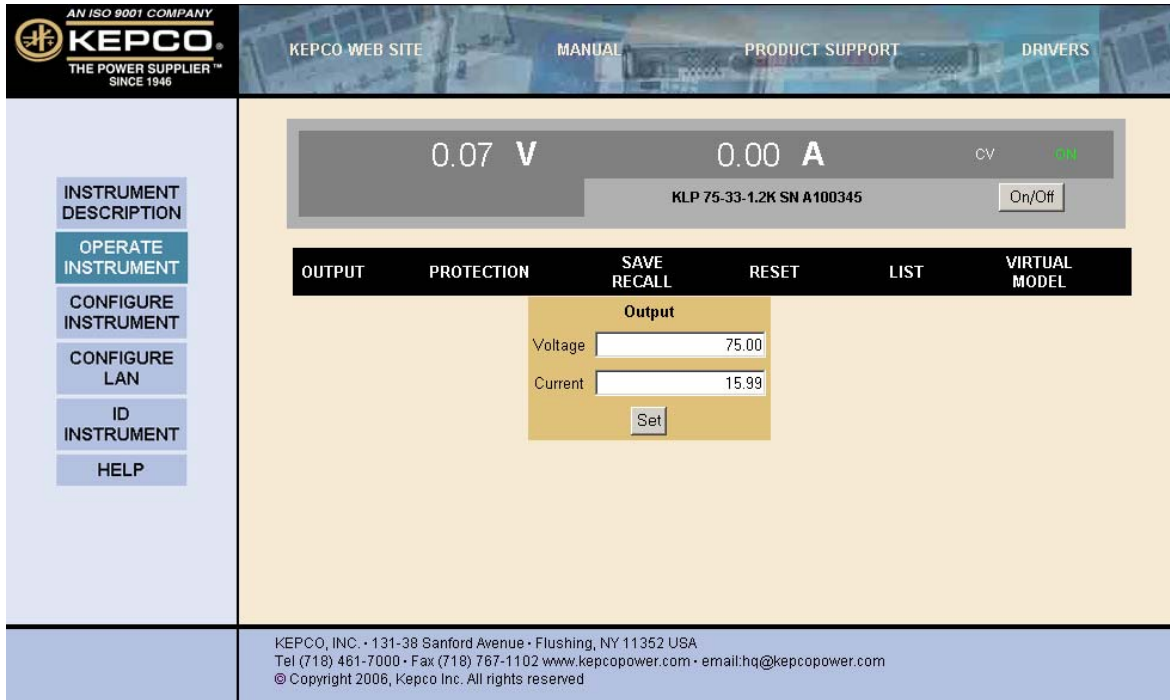

FIGURE 3-7. WEB INTERFACE OPERATE INSTRUMENT PAGE

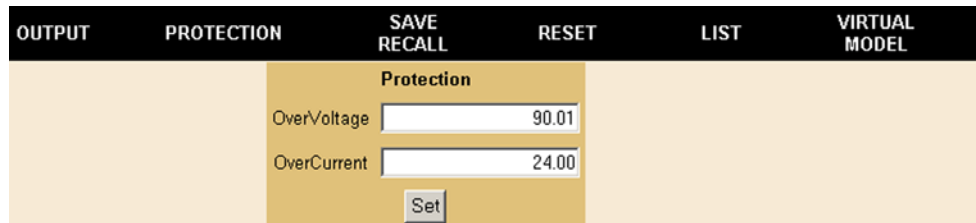

FIGURE 3-8. PROTECTION DIALOG BOX

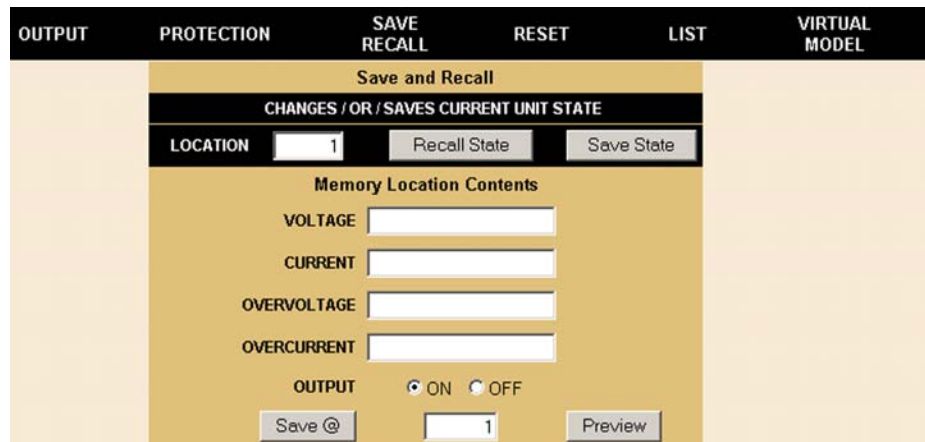

FIGURE 3-9. SAVE/RECALL DIALOG BOX

NOTE: When the SAVE/RECALL tab is initially selected, parameters for all locations appear as empty even when there are values stored from previous sessions. Click the **Preview** button first to avoid overwriting existing data.

- **To view currently stored settings:** Enter a location (1 to 40) in the box between **Save @** and **Preview** buttons, then click **Preview** button.
- **To change currently stored settings:** Enter a location (1 to 40) in the box between **Save @** and **Preview** buttons, then click **Preview** button. Modify the settings and click **Save @** button to save the modified settings.
- **To save the active settings:** Enter the desired location (1 to 40) in the **LOCATION** box and click **Save State** button to save the active settings. Only the parameters shown in Figure 3-7 can be saved.
- **To save user-determined settings:** Enter location (1 to 40) in the box between **Save @** and **Preview** buttons. Click on the Voltage or Current field and enter the new value. Pressing Enter or Tab key on computer keyboard advances the cursor to the next field while automatically filling in the corresponding Overvoltage or Overcurrent field with the larger of either the minimum value or 120% of the entered value. Using the mouse to move the cursor to the next field prevents the Overvoltage or Overcurrent field from filling in automatically, and allows the user to set custom values for Overvoltage or Overcurrent. Once the desired values for Voltage, Current, Overvoltage Protection and Overcurrent protection are entered, select whether the output is to be on or off, then click **Save @** button to save the settings
- **To Recall settings:** Enter the desired location in the **LOCATION** field and click **Recall State** to set previously stored settings as the active settings.

If a virtual model setting is changed, and a stored setting is outside the range established by the new virtual model, the data set is not loaded; although there is no indication on the web page, the Status Display of the power supply will flash E221, "Settings conflict".

3.3.6.6.4 RESETTING THE UNIT (*RST) [E-SERIES MODELS ONLY]

Click **RESET** to open the Reset dialog box, then click ***RST** button to reset power supply to the power on default state: setpoints to zero Volts and minimum Amperes (see NOTE, PAR. 3.2.1, step 3, and Table 1-3), and output set to OFF. ***RST** also clears all LIST entries.

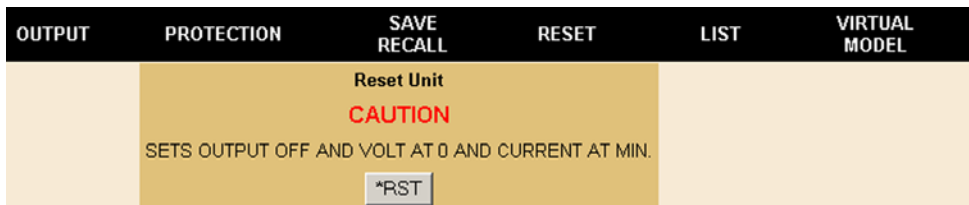

FIGURE 3-10. RESET DIALOG BOX

3.3.6.6.5 USING A LIST (USER-PROGRAMMED SEQUENCES) [E-SERIES MODELS ONLY]

Using the LIST feature, up to 100 locations are available for programming the KLP output. These locations enable the user to program the output using sequential steps which may be initiated by a single command. The repeatable user-determined sequences are stored in volatile memory and are retained until reprogrammed, the power supply is turned off, a calibration is performed, or a **LIST:CLEar** command is received. If a virtual model setting is changed, and a programmed value is outside the range established by the new virtual model, that step is executed as the default minimum (zero V, minimum A) although the location contents are not changed.

Create the List. Click **LIST** to open the List dialog box (Figure 3-11). Each location defines the values for one step: voltage and current, and a dwell time duration (between 0.5 and 655.36 seconds).

- NOTES:
1. Dwell times down to 0.01 second can be obtained using SCPI commands (via RS 232 or GPIB interfaces) to generate the list (see KLP Developer's Guide).
 2. The state of the internal relay can be stored using the VXI *plug&play* driver or SCPI LIST commands (see KLP Developer's Guide), but can not be controlled from the web interface

Click **Add to List** button to add a step (the information displayed in the Voltage, Current and Dwell boxes) to the List steps shown to the right.

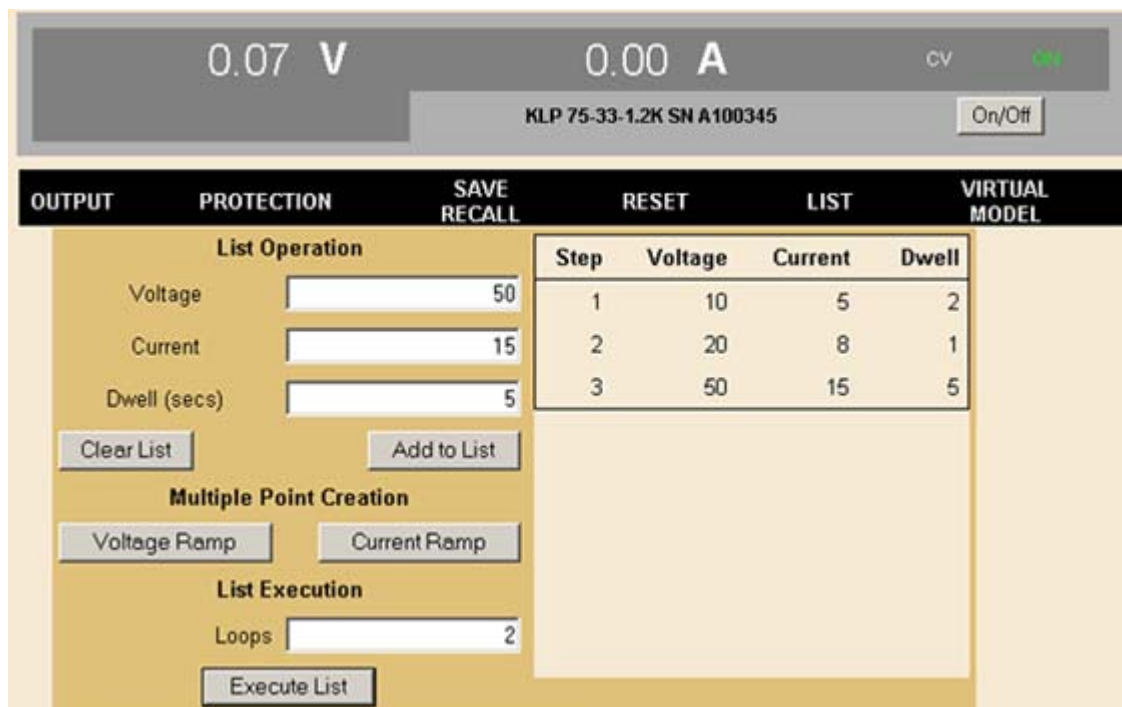

FIGURE 3-11. LIST DIALOG BOX

Clearing the List. Once a LIST has been started, the individual steps can not be changed; the only option is to delete the LIST by pressing the **Clear List** button to start over. In addition, performing any of the following operations will also clear the list: changing overcurrent or overvoltage PROTECTION settings, unit RESET (clicking *RST), changing VIRTUAL MODEL settings and exiting the OPERATE INSTRUMENT page.

Create Voltage or Current Ramps. In addition to adding single steps, the user may add multiple steps to produce voltage or current ramps. Clicking the **Voltage Ramp** or **Current Ramp** button opens similar dialog boxes (see Figure 3-12). Enter the starting and ending ramp values, the number of intermediate steps (including start and end), the total time (0.5 to 655.36 seconds) to go from the start to the end of the ramp, and a constant current (for voltage ramp) or voltage (for current ramp) for each step of the ramp. Dwell times for each step will be calculated by the firmware (total time/number of steps), and must be greater than 0.5 second. Clicking the **Create Ramp** button adds the steps to the list as the firmware calculates the intermediate voltage values and dwell times required to produce the desired ramp. Ramps with many total steps

may take a few seconds to process; the percentage complete is indicated below the **Create Ramp** button.

OUTPUT	PROTECTION	SAVE RECALL	RESET	LIST	VIRTUAL MODEL
Voltage RAMP			Current RAMP		
Start Voltage	<input type="text" value="0"/>		Start Current	<input type="text" value="20"/>	
End Voltage	<input type="text" value="10"/>		End Current	<input type="text" value="10"/>	
Steps	<input type="text" value="10"/>		Steps	<input type="text" value="10"/>	
Total Time (secs)	<input type="text" value="10"/>		Total Time (secs)	<input type="text" value="10"/>	
Current	<input type="text" value="20"/>		Voltage	<input type="text" value="35"/>	
<input type="button" value="Create Ramp"/>			<input type="button" value="Create Ramp"/>		

FIGURE 3-12. ADDING MULTIPLE STEPS (RAMPS) TO LIST

Execute the List. Steps may be added to a list using Add to List, Current Ramp or Voltage Ramp buttons, however the total number of steps can not exceed 100. To execute the list, enter the number of times the list is to be executed in the **Loops** box (1 to 65536; 0 is continuous looping), set the output on (click the **On/Off** button if necessary) and click the **Execute List** button. While the list is running, the title of the **Execute List** button changes to **Stop Execution**. After the completion of the specified number of LIST cycles, the output stabilizes at the conditions in the last LIST step.

Stop the List. If the **Stop Execution** button is clicked to stop the list, the output stays on with the voltage and current at the list values prior to the stop command, and the **Stop Execution** button reverts to **Execute List**. If the **Execute List** button is clicked again, the list restarts from the beginning. If the list is stopped by clicking the ***RST** button, the output turns off and **Output** setpoints are reset to 0V, minimum current, except that if last setting recall (PAR. 3.2.10.3) is enabled, the Setpoint values are from the last setting.

3.3.6.6.6 SETTING VIRTUAL MODEL [E-SERIES MODELS ONLY]

Refer to PAR. 3.2.9 for details about what Virtual Model means for KLP and how the virtual model affects other parameters. Click **VIRTUAL MODEL** (Figure 3-7) to open the Virtual Model dialog box (Figure 3-13). The current virtual model settings (gray) are displayed. To change the settings enter the Unit Password (see PAR. 3.2.8) and press ENTER key on the computer keyboard. After the password is accepted, the Unit Password field is inaccessible (gray) and the Maximum Voltage and Maximum Current fields can be changed. Enter the desired maximum voltage or maximum current; the other field will be filled in automatically for a maximum of 1200 Watts, then press ENTER key; all fields are gray for a second or two while the power supply accepts each entry. The Password field is reset after leaving the Virtual Model dialog box

Setting a new virtual model resets the setpoints to zero Volts and minimum Amperes and resets the OVP and OCP values to 120% of virtual model maximum. A minimum programmed current is required to ensure proper operation of the power supply under all load conditions. Programmed current is automatically set to be at least the minimum current (actual value depends on model, see Table 1-2). If DIP switch position 3 is enabled (see Table 2-2 and PAR 3.2.10.3), stored setpoints for voltage and current are cleared when the virtual model settings are saved.

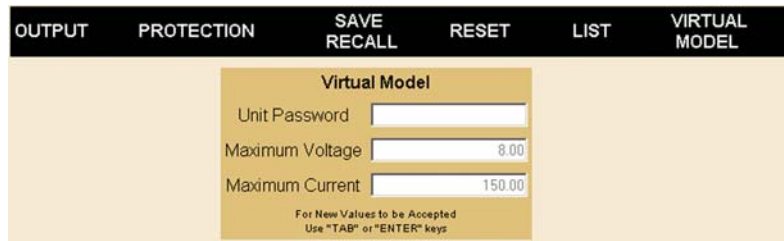

FIGURE 3-13. VIRTUAL MODEL DIALOG BOX

3.4 REMOTE PROGRAMMING USING ANALOG SIGNALS

Vref and Cref, present at the Analog Port (see J2, Figure 2-2 and Table 2-7) are the respective voltage and current programming inputs, used for programming the power supply output in proportion to either an analog voltage drive signal or programming resistance. Normally inactive, these two inputs are activated by connecting the ANALOG_CTRL pin of J2 to one of the four GND pins before switching the power supply on. Once the power supply start-up sequence is completed, the status display reads **aRem**. The default full-scale voltage level of both Vref and Cref is 10V; each parameter can be set independently to accommodate lower full scale inputs (see PAR 3.2.17.5).

While the status display reads **aRem** (Analog Remote mode), the local output controls are locked out and digital programming commands are ignored. However, local displays remain functional and digital queries related to status and readback will be accepted and executed. In addition, the analog port provides analog readback outputs corresponding to output voltage and current via the signals VOLT_R_BACK and CURR_R_BACK, respectively. These outputs are active at all times and do not require the unit to be operating in Analog Remote mode. The default full-scale voltage level of both VOLT_R_BACK and CURR_R_BACK is 10V; Similar to Vref, and Cref, the readback signal can be set independently to produce lower full-scale outputs (see PAR 3.2.17.4).

Analog programming inputs are updated once every 0.5 seconds (2 Hz). The default full-scale programming and readback levels for both voltage and current are 10V. Since Vref and Cref are converted to digital form, then processed by the digital processing circuitry of KLP (the same as any other programming input), optimum (12-bit) resolution is achieved when 10V programming input is equivalent to full scale. **It is important to note that the full scale programming input levels of Vref and Cref correspond to the active limit model setting of the power supply.** Thus, if KLP 75-33 is programmed as a virtual model 50V and 20A, applying the full scale programming input to Vref and Cref will program the output for 50V and 20A, respectively. One benefit of this feature is the preservation of full 12-bit programming resolution for limit model settings that are less than the model maximum ratings (Vmax and Imax) as long as 10V analog input is equivalent to full scale. While the full-scale voltage and readback levels can be reduced by the user to accommodate system requirements, decreasing the full scale values will result in degraded programming resolution.

Refer to PAR 3.2.6 for enabling/disabling the output using Remote Inhibit. Refer to PAR. 3.2.2 for instructions on exiting Analog Remote mode.

The remaining functions present at the Analog I/O Port connector, including the fault relay (RELAY_NO, RELAY_NC, RELAY_COM) and external trigger (EXT_TRG), remain active for all operating modes.

3.4.1 PROGRAMMING WITH EXTERNAL RESISTANCE

Figure 3-14 is a simplified diagrams of the KLP showing the switch configuration and external connections required for analog programming using an external resistance.

1. Virtual model (PAR. 3.2.9) and Overvoltage and Overcurrent settings (PAR 3.4.3) must be established via either local programming or digital remote programming prior to initiating Analog Remote programming.
2. Turn off power and configure the Analog I/O DIP switch (Figure 2-2) as follows:
 - SW1: ON (Program output voltage via resistance)
 - SW2: ON (Program output current via resistance)
 - SW3: either OFF or ON (disabled when in remote analog programming mode; see Table 2-2)
 - SW4: Reserved - Do not use.
 - SW5: Either OFF (Local controls enabled) or ON (Local controls locked)
3. Configure Analog I/O Port J2 (Figure 2-2) by referring to Table 2-7 and Figure 3-14 (grounding J1 pin 12 enables analog programming).

NOTES:

1. R1 PROGRAMS OUTPUT CURRENT
2. R2 PROGRAMS OUTPUT VOLTAGE
3. MAY BE SET TO ON TO LOCK LOCAL CONTROLS.

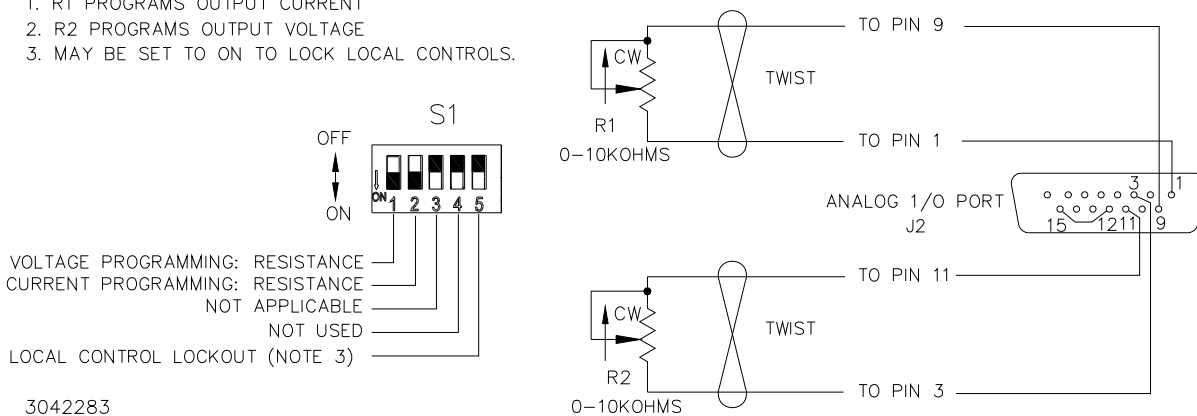

FIGURE 3-14. ANALOG PROGRAMMING OF OUTPUT VOLTAGE OR CURRENT USING RESISTANCE

With the power supply configured as shown in Figure 3-14 and assuming the load causes the power supply to operate in voltage mode, varying external resistor R2 from 0 to 10K causes the output voltage of the power supply to vary linearly from 0 to full scale, while R1 can be used to adjust the current limit. When the power supply operates in current mode, R2 will adjust the voltage limit and R1 will adjust output current.

Factory default full scale (F.S.) resistance programming is 10K ohms based on F.S. programming voltage of 10V. To set full scale resistance to a lower value, see PAR. 3.2.17.4 to change the F.S. programming voltage to a lower value, then adjust based on 1000 ohms/Volt.

3.4.2 PROGRAMMING WITH EXTERNAL VOLTAGE

Figure 3-15 is a simplified diagrams of the KLP showing the switch configuration and external connections required for analog programming using an external voltage.

1. Virtual Model (PAR. 3.2.9) and Overvoltage and Overcurrent settings (PAR. 3.4.3) must be established via either local programming or digital remote programming prior to initiating Analog Remote programming.
2. Turn off power and configure the Analog I/O DIP switch (Figure 2-2) as follows:
 - SW1: OFF (Program output voltage via voltage)
 - SW2: OFF (Program output current via voltage)
 - SW3: either OFF or ON (disabled when in remote analog programming mode; see Table 2-2)
 - SW4: Reserved - Do not use
 - SW5: Either OFF (Local controls enabled) or ON (Local controls locked)
3. Configure Analog I/O Port J2 (Figure 2-2) by referring to Table 2-7 and Figure 3-15 (grounding J1 pin 12 enables analog programming).
4. Refer to PAR. 3.4.3 to change overvoltage or overcurrent setting in analog programming mode.

With the power supply configured as shown in Figure 3-15 and assuming the load causes the power supply to operate in voltage mode, varying source voltage V2 from 0 to maximum causes the output voltage of the power supply to vary linearly from 0 to full scale, while V1 can be used to adjust the current limit. When the power supply operates in current mode, V2 will adjust the voltage limit and V1 will adjust output current.

Factory default full scale (F.S.) voltage programming is 10V. To set full scale voltage programming to a lower value, see PAR. 3.2.17.4

NOTES:

1. V1 PROGRAMS OUTPUT CURRENT.
2. V2 PROGRAMS OUTPUT VOLTAGE.
3. MAY BE SET TO ON TO LOCK LOCAL CONTROLS.

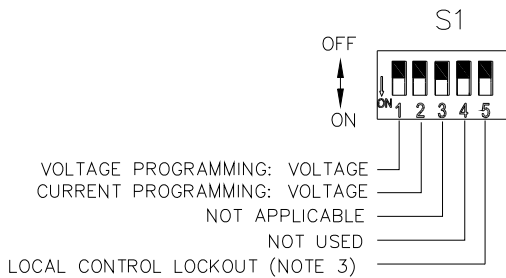

3042284

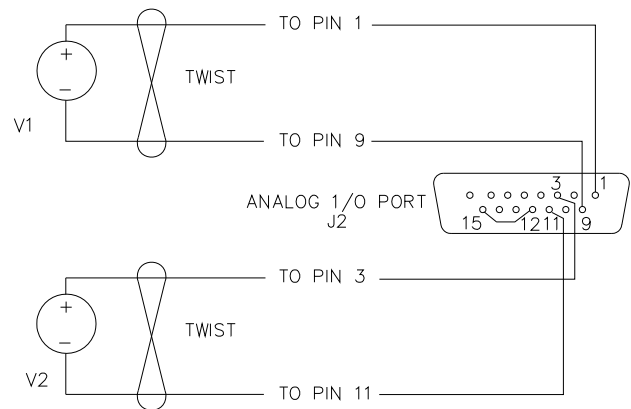

FIGURE 3-15. ANALOG PROGRAMMING OF OUTPUT VOLTAGE OR CURRENT USING VOLTAGE

3.4.3 CHANGING OVERVOLTAGE OR OVERCURRENT PROTECTION VALUES IN ANALOG PROGRAMMING MODE

Overvoltage and overcurrent values can not be changed using analog remote programming; this can only be done by issuing a command via the GPIB or RS 232 port, or via local mode from the front panel (enter local mode by pressing the VOLTAGE and CURRENT adjustment controls at the same time, then see PAR. 3.2.11).

If the panel is locked and RS 232 or GPIB access is not possible, turn the power supply off, set ANALOG I/O DIP switch position 5 to OFF, and then power up again to unlock the panel (PAR.3.2.2.1). After the settings have been changed, turn the power supply off, set ANALOG I/O DIP switch position 5 to ON to relock the panel, then turn on the power supply to restore Analog Remote Programming (status display reads aRem).

SECTION 4 - CALIBRATION

4.1 GENERAL

This section contains the calibration instructions for the Power Supply. It is recommended that the user be familiar with Local Mode operation (PAR.3.2) before calibrating the unit.

A full calibration consist of a voltage calibration and a current calibration. Both voltage and current calibrations consist of a zero and a full scale calibration.

External calibration calibrates the precise user-defined reference voltages used that will be equivalent to full scale output when external analog programming is used.

NOTE: Calibrating the unit resets all internal memory locations used for saving active settings (*SAV, *RCL), programmed sequences using the LIST commands, and trigger levels established by CURR:TRIG and VOLT:TRIG. These parameters are returned to the default minimum (0V, minimum A). In addition, values for full scale voltage and current in INVC registers (ANPR and ANRB default values) are set to 10V.

In order to enter the calibration mode the correct unit password must be entered. If the password has been forgotten, call the factory and a special password (which has been assigned to your power supply) will be provided. During the calibration, new calibration data is computed which is then stored in the nonvolatile memory either when EXIT is executed (local mode, PAR. 4.3.4) or SAVE Calibration is executed (remote mode, PAR 4.4.4).

Calibration of the KLP is performed in one of two ways: locally using the front panel controls (PAR. 4.3), or remotely using the graphical interface supplied with the VXI *plug&play* instrument driver available at www.kepcopower.com/drivers/ (PAR 4.4)). The VISA compliant VXI *plug&play* driver works with many GPIB cards from suppliers such as National Instruments and Hewlett-Packard. These two ways cannot be combined.

NOTE: Calibration of a master/slave configuration requires that both units be restored to standalone operation (see PAR. 3.2.14.4 for instructions) and calibrated individually.

4.2 EQUIPMENT REQUIRED

The following equipment is required to calibrate the KLP Power Supply.

- Digital Voltmeter (DVM) with 6 digits resolution and at least 0.002% accuracy for d-c measurements.

NOTE: Because the voltage measured will be used as a reference for calibration, the DVM used must be accurately calibrated prior to calibrating the power supply.

- Precision Shunt Resistor (with a tolerance of 0.01%, power rating of at least 10 times larger than the maximum stress, and a temperature coefficient equal to or better than 20 ppm per degree C).

NOTE: Proper cooling of the external precision shunt resistor ensures the accuracy of the calibration.

- A stable, clean d-c power source capable of supplying 10.0000V (or other desired full scale analog voltage) at 10mA minimum (a linear power supply or reference voltage I.C. is recommended).

4.3 CALIBRATION USING FRONT PANEL CONTROLS IN LOCAL MODE

For voltage calibration all loads must be disconnected and the sense terminals connected to the corresponding output terminals. The digital voltmeter will be connected to the output of the power supply. For current calibration after disconnecting all loads an appropriate shunt resistor will be connected across the output terminals and the digital voltmeter will be connected to the sense terminals of the shunt resistor.

1. Turn off power supply and disconnect load from output terminals at the rear of the unit.
2. Verify that power supply is configured for local error sensing (PAR. 2.7.5.1).
3. For voltage calibration connect DVM to (M+, S+) and (M-, S-) of terminal block at the rear of power supply.
4. For current calibration connect an appropriate shunt resistor (see PAR 4.2) across the output terminals and connect DVM to shunt resistor terminals.
5. Configure the mating I/O connector (provided with unit) to access the input programming signals (Vref and Cref) and output readback signals (VOLT_RBACK and CURR_RBACK) as shown in Figure 4-1. Note that the wires to Vref and Cref should be tightly twisted with the corresponding GND wire and kept as short as possible. Then connect the I/O mating connector to the Analog I/O port of the power supply.

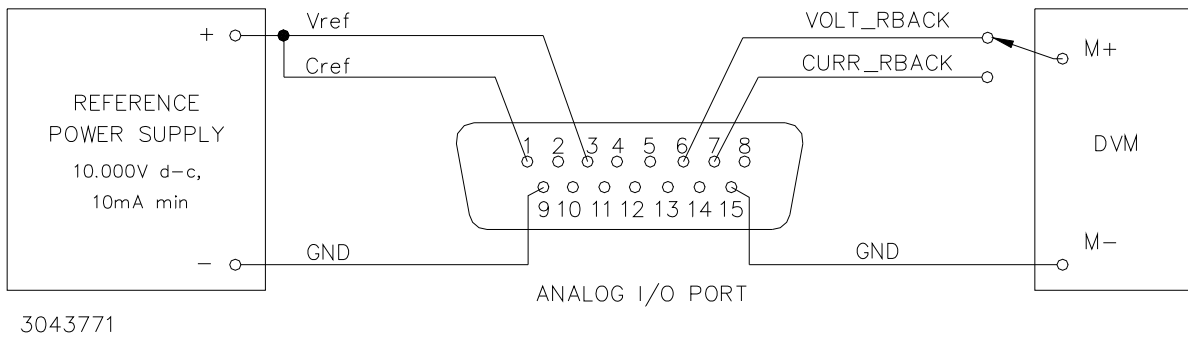

FIGURE 4-1. ANALOG PORT WIRING FOR CALIBRATION

6. Turn on power supply, exit **SET** mode by tapping either **VOLTAGE** or **CURRENT** control and using a thin tool (e.g., a paper clip), press the **FUNCTION** switch once until the status display reads **VIRT**, then rotate either the **VOLTAGE** or **CURRENT** control in either direction until status display reads **UTIL**.
7. Tap the **DC OUTPUT** switch once, then rotate either the **VOLTAGE** or **CURRENT** control in either direction until status display reads **CAL**. The last calibration date is displayed (see PAR. 4.3.4 for details) and the **DC AMPERES** display reads 0000 with the left-most digit blinking.
8. Tap **DC OUTPUT** switch to enter calibration mode. The status display shows **PASS**. Enter the password (see PAR. 3.2.8) and tap **DC OUTPUT** switch to accept the number.

- When the password is accepted, status display reads v ?. Rotating either **VOLTAGE** or **CURRENT** control continuously cycles through all the calibration choices. The status display reads: v ? for voltage calibration c ? for current calibration, **EXT?** for remote analog calibration, and **EXIT** to save the calibrated results. Tap the **FUNCTION** switch to exit calibration WITHOUT saving any calibration data (see PAR. 4.3.4). Tap the **DC OUTPUT** switch to select the displayed choice.

NOTE: Calibrations may be done in any order.

- Proceed to PAR. 4.3.1 for voltage calibration, PAR 4.3.2 for current calibration, PAR. 4.3.3 for external calibration or PAR. 4.3.4 to exit calibration

4.3.1 VOLTAGE CALIBRATION (LOCAL)

During voltage calibration, the voltage, voltage readback and remote analog voltage readback are calibrated.

- Minimum voltage is first. To start, tap the **DC OUTPUT** switch while v ? appears in the status display: the status display then reads v_0 . Monitor DVM and rotate the **VOLTAGE** control to increase or decrease the output voltage until the DVM reads minimum positive or zero Volts.
- Tap the **DC OUTPUT** switch to accept the value. The status display then reads **vMAX**. Monitor DVM and rotate the **VOLTAGE** control to increase or decrease the output voltage until the DVM reads as close as possible to (but not less than) the rated model voltage (see Table 1-2).
- Tap the **DC OUTPUT** switch to accept the value; the status display now reads **OUTV**. At the ANALOG I/O PORT J2, connect the DVM to VOLT_RBACK and GND as shown in Figure 4-1. Rotate the **VOLTAGE** control to increase or decrease the output voltage until the DVM reads as close as possible to 10V.
- Tap the **DC OUTPUT** switch to accept the value. The status display reads c ?. Tap the **DC OUTPUT** switch to proceed to Current Calibration (see PAR. 4.3.2), or rotate either **VOLTAGE** or **CURRENT** control to advance to next choice

4.3.2 CURRENT CALIBRATION (LOCAL)

During current calibration, the current, current readback and analog current readback are calibrated.

- The status display reads **LOAD**. When the shunt and DVM are connected per PAR. 4.3, step 4, tap the **DC OUTPUT** switch. The status display reads **cMAX**.
- Rotate the **CURRENT** control to increase or decrease the DVM reading until the DVM reading corresponds as close as possible to maximum rated current (Calculate current as follows:
 I (Amperes) = DVM reading (Volts) / Shunt Resistance (Ohms).
- Tap the **DC OUTPUT** switch to accept the value. The status display reads c_0 . Rotate the **CURRENT** control to increase or decrease the DVM reading until the DVM reading corresponds to minimum positive or zero current (Calculate current as follows:
 I (Amperes) = DVM reading (Volts) / Shunt Resistance (Ohms).

4. Tap the **DC OUTPUT** switch to accept the value. The status display reads **C_{MAX}**. Rotate the **CURRENT** control to increase or decrease the DVM reading until the DVM reading corresponds as close as possible to (but not less than) the maximum rated current (see Table 1-2). Calculate current as follows:

$$I \text{ (Amperes)} = \text{DVM reading (Volts)} / \text{Shunt Resistance (Ohms)}$$
5. Tap the **DC OUTPUT** switch to accept the value; the status display now reads **OUTC**. At the ANALOG I/O PORT J2, connect the DVM to CURR_RBACK and GND as shown in Figure 4-1. Rotate the **CURRENT** control to increase or decrease the output voltage until the DVM reads as close as possible to 10V.
6. Tap the **DC OUTPUT** switch to accept the value. The status display reads **EXT?**. Tap the **DC OUTPUT** switch to proceed to External Calibration (see PAR. 4.3.2), or rotate either **VOLTAGE** or **CURRENT** control to advance to next choice

4.3.3 EXTERNAL CALIBRATION (LOCAL)

During external calibration the external analog reference voltages used to establish full scale output current and voltage are calibrated.

1. The status display reads **INPV**. With the reference voltage adjusted to 10.000V, tap the **DC OUTPUT** switch to accept the value.
2. The status display reads **INPC**. With the reference voltage adjusted to 10.000V, tap the **DC OUTPUT** switch to accept the value.
3. The status display reads **EXIT**. Proceed to PAR. 4.3.4 to exit calibration.

4.3.4 CALIBRATION EXIT (LOCAL)

NOTE: Using a thin tool (e.g., a paper clip), tap the **FUNCTION** switch to exit calibration WITHOUT saving any calibration data.

1. When the status display reads **EXIT**, tap the **DC OUTPUT** switch to save the calibration.
2. The status display reads **DATE**. The **DC VOLTS** display represents MMDD (month, day) and the **DC AMPS** display represents YYYY (year). The factory calibration date is displayed with the first digit blinking as a starting point to enter the current date. Rotate either the **VOLTAGE** or **CURRENT** controls to change the digit, then tap either control to move to the next digit.

NOTE: For purposes of traceability the user is strongly urged to enter the calibration date upon completion of calibration. If a date is not entered, no date is saved.

3. Tap **DC OUTPUT** switch to accept date. If any calibration (voltage, current or external) was completed, the unit will save the new calibration. The status display reads "DONE" while calibration is being saved.
4. Once saved the unit enters Virtual Model mode. Follow the procedure in PAR 3.2.9 to set the virtual model.

NOTE: The virtual model is always reset following calibration. If voltage calibration is completed (regardless of whether or not current calibration is completed), the virtual model voltage is set for maximum rated voltage, and current is set to the value corresponding to 1200 Watts. If ONLY current calibration is completed, the virtual model current will be set for maximum rated current and voltage is set to the value corresponding to 1200 Watts.

4.4 CALIBRATION USING VXI *plug&play* DRIVER

Calibration of the KLP can be performed using SCPI commands implemented through the VXI *plug&play* Instrument driver. The driver provides a graphical interface with informational displays and prompts which lead you through the calibration of the KLP. This VISA compliant driver works with many GPIB cards from suppliers such as National Instruments and Hewlett-Packard.

The following calibration procedure uses the “soft” front panel which is part of the VXI *plug&play* driver for the KLP which can be downloaded from the Kepco website at: www.kepcopower.com/drivers/.

Unzip the files and doubleclick on setup.exe to install the driver. The Kepco\klp folder will be added to the Start - Programs folder. Doubleclick KLPCTRL.exe to run the program, and refer to the KLP Developer’s Guide in the Kepco\klp folder for details about using the soft front panel.

For voltage calibration all loads must be disconnected and the sense terminals connected to the corresponding output terminals. The digital voltmeter will be connected to the output of the power supply. For current calibration after disconnecting all loads an appropriate shunt resistor will be connected across the output terminals and the digital voltmeter will be connected to the sense terminals of the shunt resistor.

1. Turn off power supply and disconnect load from output bus bar at the rear of the unit.
2. Verify that power supply is configured for local error sensing (See PAR. 2.7.5.1).
3. For voltage calibration connect DVM to (M+, S+) and (M–, S–) of terminal block at the rear of power supply.
4. For current calibration connect an appropriate shunt resistor (see PAR 4.2) across the output terminals and connect DVM to shunt resistor terminals.
5. Configure the mating I/O connector (provided with unit) to access the input programming signals (Vref and Cref) and output readback signals (VOLT_RBACK and CURR_RBACK) as shown in Figure 4-1. Note that the wires to Vref and Cref should be tightly twisted with the corresponding GND wire and kept as short as possible. Then connect the I/O mating connector to the Analog I/O port of the power supply.
6. Turn on power supply, and after the status display shows **SET**, start the KLP VXI *plug&play* demo program.
7. Click the **Calibrate Access** button on the VXI *plug&play* demo main panel: the button label changes to **Calibrate Close** and the Calibration Window (Figure 4-2) opens with all buttons disabled (grayed out) and PASSWORD appears in the text box near the top of the window. The main panel status display shows calibration, and the voltage and current meters are not visible.

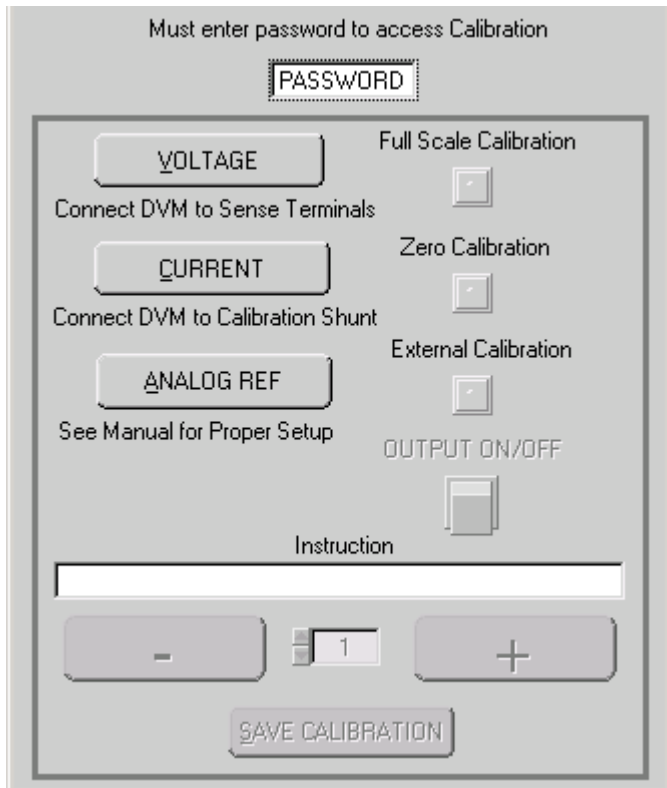

FIGURE 4-2. CALIBRATION WINDOW

8. Use the computer keyboard to enter the password in the text box displaying the word PASSWORD, then press the ENTER key.
9. If password is correct, the status display on the VXI main panel reads CAL and the buttons on Calibration Screen (Figure 4-1) are enabled (highlighted). If the password is incorrect, the password text box displays “WRONG #”. Repeat step 7 to enter the correct password, or click the **Calibrate Close** button on the VXI main panel to exit calibration.

NOTE: Calibrations may be done in any order.

10. Proceed to PAR. 4.4.1 for voltage calibration, PAR 4.4.2 for current calibration., PAR. 4.4.3 for external calibration or PAR. 4.4.4 to exit calibration

4.4.1 VOLTAGE CALIBRATION (VXI *plug&play* DRIVER DEMO)

During voltage calibration, the voltage, voltage readback and remote analog voltage readback are calibrated.

1. Click the **VOLTAGE** button on the Calibration window to start voltage calibration: the Voltage Calibration Window (Figure 4-3) appears. Minimum voltage is first; the status display on both the UUT and the VXI main panel) reads **V_0**. Monitor DVM and click the “+” button to increase and the “-” to decrease the output voltage until the DVM reads as close as possible to minimum rated POSITIVE voltage or zero.

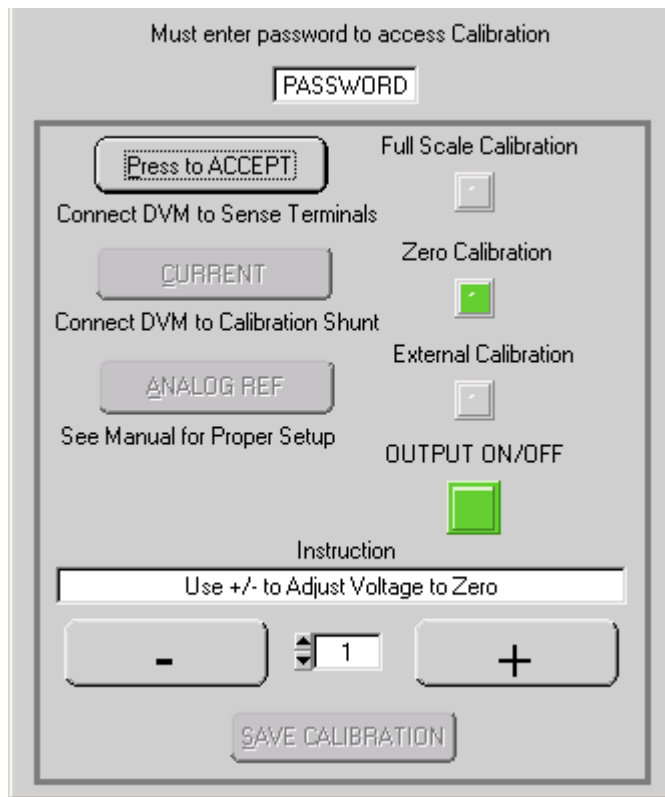

FIGURE 4-3. VOLTAGE CALIBRATION WINDOW

2. Click the **Press to ACCEPT** button to accept the value. The status display then reads **VMAX**. Monitor DVM and click the “+” button to increase and the “-” to decrease the output voltage until the DVM reads as close as possible to maximum rated voltage.
3. Click the **Press to ACCEPT** button to accept the value; the status display now reads **OUTV**. At the ANALOG I/O PORT J2, connect the DVM to VOLT_RBACK and GND as shown in Figure 4-1. Click the “+” button to increase and the “-” button to decrease the output voltage until the DVM reads as close as possible to 10V.
4. Click the **Press to ACCEPT** button to accept the value. The status display will not change. At the calibration window, click the **CURRENT** Button to proceed to current calibration (see PAR. 4.4.2).

4.4.2 CURRENT CALIBRATION (VXI *plug&play* DEMO)

During current calibration, the current, current readback and analog current readback are calibrated.

1. Click the **CURRENT** button on the Calibration Window to start current calibration; a pop-up box appears instructing the operator to connect the shunt across the output terminals. Once the shunt is connected, click OK; the Current Calibration Window (Figure 4-4) appears and the status display on the VXI main panel reads **CMAX**.

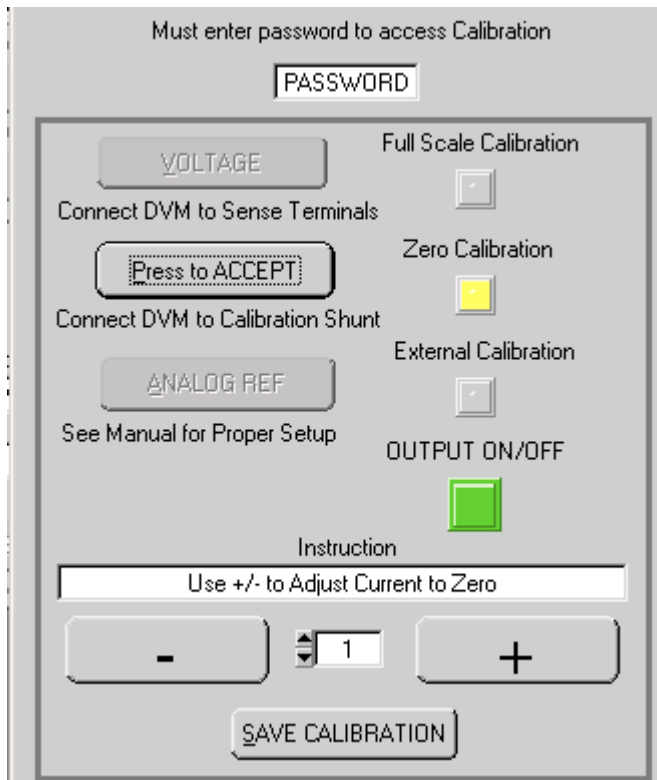

FIGURE 4-4. CURRENT CALIBRATION WINDOW

2. Monitor DVM and click the “+” button to increase and the “–” to decrease the output current until the DVM reads as close as possible to maximum rated current (Calculate current as follows:

$$I \text{ (Amperes)} = \text{DVM reading (Volts)} / \text{Shunt Resistance (Ohms)}.$$
3. Click the **PRESS TO ACCEPT** button to accept the value. The status display reads **C_0**. Click the “+” button to increase and the “–” to decrease the output current until the DVM reads as close as possible to minimum positive or zero current (Calculate current as follows:

$$\text{(Amperes)} = \text{DVM reading (Volts)} / \text{Shunt Resistance (Ohms)}.$$
4. Click the **PRESS TO ACCEPT** button to accept the value. The status display reads **CMAX**. Click the “+” button to increase and the “–” to decrease the output current until the DVM reads as close as possible to maximum rated current (Calculate current as follows:

$$I \text{ (Amperes)} = \text{DVM reading (Volts)} / \text{Shunt Resistance (Ohms)}.$$
5. Click the **Press to ACCEPT** button to accept the value; the status display now reads **OUTC**. At the ANALOG I/O PORT J2, connect the DVM to CURR_RBACK and GND as shown in Figure 4-1. Click the “+” button to increase and the “–” to decrease the output current until the DVM reads as close as possible to 10V.

- Click the **PRESS TO ACCEPT** button to accept the value. The status display will not change. Click the **ANALOG REF** button on the calibration window to proceed to external calibration (see PAR. 4.4.3).

4.4.3 ANALOG REFERENCE CALIBRATION (VXI *plug&play* DEMO)

During analog reference calibration the external analog reference voltages used to establish full scale output current and voltage are calibrated.

- Click the **ANALOG REF** button on the Calibration Window; the Analog Reference Calibration Window (Figure 4-5) appears and the status display on the VXI main panel reads **INPV**. With the reference voltage adjusted to 10.000V, click the **PRESS TO ACCEPT** button to accept the value. When the calibration is saved, this analog voltage will be equivalent to full scale output voltage.

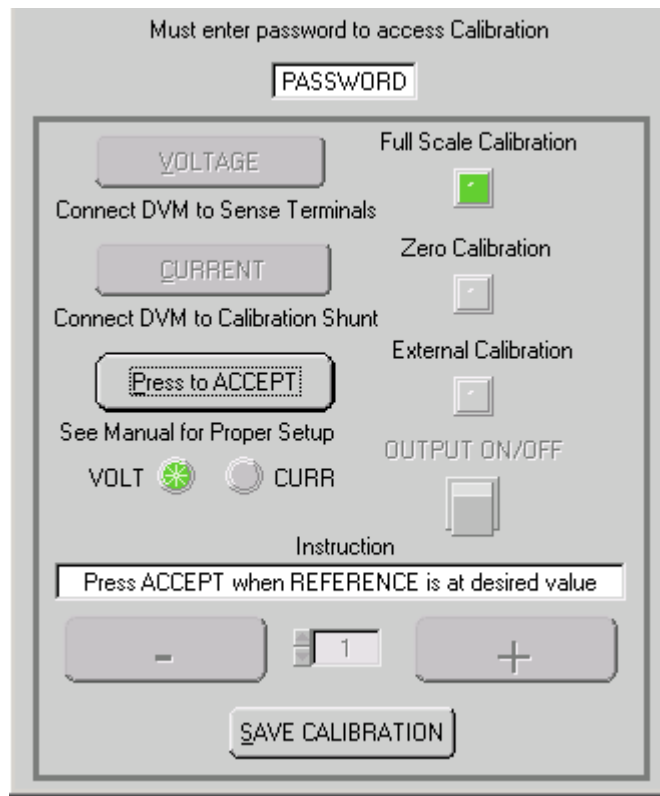

FIGURE 4-5. ANALOG REFERENCE CALIBRATION WINDOW

- The status display reads **INPC**. With the reference voltage adjusted to 10.000V, click the **PRESS TO ACCEPT** button to accept the value.
- The status display will not change. Proceed to PAR. 4.4.4 to exit calibration.

4.4.4 CALIBRATION EXIT (VXI *plug&play* DEMO)

NOTE: Clicking the Calibrate **Close** button on the VXI main panel will exit calibration WITHOUT saving any calibration data.

1. Click the **SAVE CALIBRATION** button on the calibration window to save this calibration.
2. The Calibration window automatically closes and the Virtual Model window automatically opens.
3. The virtual model settings can be changed after the password has been properly entered.
4. NOTE: The virtual model is always reset following calibration. If voltage calibration is completed (regardless of whether or not current calibration is completed), the virtual model voltage is set for maximum rated voltage, and current is set to the value corresponding to 1200 Watts. If a current calibration is completed, but no Voltage calibration, the virtual model current will be set for maximum rated current and voltage is set to the value corresponding to 1200 Watts.

4.5 CHANGING THE CALIBRATION PASSWORD

The 4-digit Unit password is required for to enter calibration mode. The factory default Unit password is listed in Table 4-1. To change the password from the front panel proceed as follows:

TABLE 4-1.FACTORY DEFAULT UNIT PASSWORDS

MODEL (STANDARD OR E-SERIES)	UNIT PASSWORD
KLP 10-150	1015
KLP 20-120	2012
KLP 36-60	3660
KLP 75-33	7533
KLP 150-16	1516
KLP 300-8	3008
KLP 600-4	6004

1. If the status display shows **SET**, tap either the **CURRENT** or **VOLTAGE** controls to take the unit out of setpoint mode (status display goes from **SET** to blank)
2. Using two thin tools, while holding the **PROTECT** switch in, tap the **FUNCTION** switch once. Status display reads **PASS**.

NOTE: The **FUNCTION** switch must be actuated within two seconds, i.e., before **PROT** appears in the status display. To exit this procedure without changing the password, rotate the **VOLTAGE** control.

3. Tap the **DC OUTPUT** switch. Status display reads **OLD?**.
4. Rotate the **CURRENT** control until first position of the **DC AMPERES** display shows the first character of the old password. Tap the **CURRENT** control to move to the next character. Proceed as for the first character unit all four characters of the old password are displayed. Tap the **DC OUTPUT** switch to enter. Status display shows **NEW?**.

NOTE: To reset a lost or forgotten password, contact Kepco. The password used in step 4 of the reset process may contain a decimal point. The decimal point is selected (step 4 only) when rotating the **CURRENT** control clockwise one click past 9, or counterclockwise one click past 0..

5. Following the same process as described in step 4, use the **CURRENT** control to show the new password in the **DC AMPERES** display. Tap the **DC OUTPUT** switch to enter. Status display shows **RPT?**.

6. Following the same process as described in step 4, use the **CURRENT** control to show the new password in the **DC AMPERES** display. Tap the **DC OUTPUT** switch to enter. Status display reads **DONE** and then goes blank.

NOTE: If the password is not the same as entered in step 5, the password will remain unchanged and the **STATUS** display shows **ERR**. To change the password the entire procedure must be repeated.

4.6 RESTORING PRIOR CALIBRATION VALUES

Calibration values for KLP are stored in three separate locations in flash memory designated: Factory, Prior and Working. Each time the unit is calibrated, the Working values are moved to Prior, and the new calibration values are stored in Working. Factory values cannot be altered by the user. The values in Working are the ones used by the power supply during operation.

During item final test at Kepco, Factory values are established during calibration and are copied to all three locations. Should a unit be returned to Kepco for repair or retest, the recalibration accompanying this testing will overwrite the contents of all three locations with the latest Factory values.

Should the need arise, it is possible to replace the Working calibration values with the Factory calibration values via one of the digital programming ports using the SCPI command string **CAL:DMP? [source];:CAL:COPY [destination]**, where [source] and [destination] refer to the location of calibration values desired: FACT for factory and WORK for working. The calibration values are protected by the calibration password.

For example, to restore the Factory calibration values as the Working values the user would send the following commands (presented in short form, with xxxx representing the applicable calibration password):

```
SYST:PASS:CEN [xxxx]
```

```
CAL:DMP? FACT;:CAL:COPY WORK
```

```
SYST:PASS:CDIS [xxxx]
```

The Utilities section of the KLP VXI PLUG&PLAY driver may be used both to archive and restore calibration files. The driver is available for download at:

www.kepcopower.com/drivers/index.htm

Consult the KLP Developer's Guide for instructions on implementing these functions.

KLP INSTALLATION/OPERATION SUMMARY

This summary can be printed as a handy overview to common tasks covered in the KLP User Manual, and includes hyperlinked references to appropriate paragraphs, Tables and Figures and Kepco website pages for more details.

INITIAL SETUP INSTRUCTIONS

- 1. Location:** Do not obstruct front and rear panel vents; additional clearance at side, top and bottom vents is recommended.
- 2. Connect power supply output to load:**
 - Voltage drop must be less than 0.25V per conductor (see Nomograph1 at <http://www.kepcopower.com/nomomax.htm>)
 - Local error sense operation is factory default; for remote error sense operation see PAR. 2.7.5.1.
 - For parallel or series operation of two or more power supplies see PAR. 2.7.7 and 2.7.6, respectively.
- 3. Connect remote programming cables (if applicable):** Only one remote programming input may be active at a time.
 - **Remote analog programming:** Connect programming cable between programming source and J2; see Table 2-7 and PAR. 2.7.9.
 - **Digital programming using GPIB:** Connect programming cable between host computer and J4; see Table 2-3 and PAR. 2.8.1.
 - **Digital programming using RS 232 [standard models only]:** Connect programming cable between host computer and J3; see PAR. 2.8.2 and Table 2-4.
 - **Digital programming using LAN [E-Series models only]:** Connect LAN cable between host computer and J3; see PAR. 2.8.3 and Table 2-5.
- 4. Connect power supply to power source using one of the following:** See PAR. 2.7.2 for additional information.
 - Use standard NEMA line cord set from Kepco (see Table 1-5) or customized line cord using user-wireable mating connector (supplied) in conjunction with user-selected line cord or discrete wiring as applicable.
 - See PAR. 2.7.2.1 for source power branch current rating and overload protection recommendations.
- 5. Apply source power:** Set Power ON/OFF circuit breaker/switch on front panel to ON. Apply firm, continuous pressure to rocker actuator until fully engaged (right side of rocker actuator locked parallel to front panel). If actuator does not lock when released, allow actuator to return to starting position, then wait a few seconds before repeating turn-on sequence. DO NOT attempt to "tease" the switch contacts closed by repetitive press-and-release action. The circuit breaker is "trip-free" design; if overload exists, contacts cannot be held closed by actuator.

LOCAL OPERATING MODE INSTRUCTIONS

How do I enable/disable the output? Press DC OUTPUT to toggle output on and off. *The output cannot be enabled while SET appears in the status display; tap either knob to exit setpoint mode.* The output can be disabled at any time. VOLTS and AMPS displays show actual output parameters as determined by the load (see PAR. 3.2.5).

How do I establish the operating mode? Operating mode is determined automatically by the programmed voltage (V_p) and current (I_p) settings and the load. If the load impedance is greater than V_p/I_p , the unit operates in CV mode (voltage stabilized to voltage setpoint). If the load impedance is less than V_p/I_p , the unit operates in CC mode (current stabilized to current setpoint) (see PAR. 3.2.10). Crossover between operating modes is seamless and automatic. CV and CC indicators show present mode.

How do I adjust output voltage or current (real-time)? Enable the output. If in CV mode (indicator lit), rotate Voltage knob until VOLTS display shows desired output voltage. (See PAR. 3.2.4 for coarse/fine preference.) If in CC mode (indicator lit), rotate Current knob until AMPS display shows desired output current. Rotating knob controlling limit parameter (Voltage in CC mode, Current in CV mode) changes limit setting, however change is invisible since actual outputs are displayed on VOLTS and AMPS displays (see PAR. 3.2.10.1).

How can I see what the voltage and current setpoints are? Tap (press and release) either Voltage or Current knob once to enter setpoint mode (status reads SET). VOLTS and AMPS displays show the setpoints. Tap either knob once to exit setpoint mode (SET disappears) (see PAR. 3.2.10.2).

How do I change voltage and current setpoints (enter and exit setpoint mode)? *Setpoint mode can be entered with output enabled or disabled, but output CAN NOT be enabled while setpoint mode is active.* Tap (press and release) either Voltage or Current knob once to enter setpoint mode (status reads SET). Rotate Voltage and Current knobs until desired values appear in VOLTS and AMPS displays; pressing and holding control knob in while turning provides fine adjustment. Tap either knob once to exit setpoint mode (SET disappears) (see PAR. 3.2.10.2).

What happens when setpoint mode is exited? If the output is enabled, exiting setpoint causes output to jump to new setpoints. If the output was disabled prior to or while in setpoint, exiting setpoint stores the new settings in memory; when output is enabled, output jumps to programmed setpoints. When setpoint is exited, VOLTS and AMPS revert to actual output values as determined by the load.

How do I enter a Password? Password is required to set Virtual Model or calibrate the unit. Status shows PASS (password) and Current Display shows 0000. Rotate Current knob to select a number from 0-9. Tap Current knob to advance to next digit. Repeat until all four digits have been selected. Tap DC OUTPUT to accept the number. See Table 4-1 for default passwords.

How do I enter/exit Function mode? To enter a function, press FUNCTION using a thin tool once so status reads VIRT (virtual model, see below); rotate Voltage or Current knobs for ADDR (set GPIB address, PAR. 3.2.12), BAUD (standard models only, set RS 232 baud rate, PAR. 3.2.13), LAN (E-Series models only, configure LAN parameters. see PAR. 3.2.15), M/S (standard models only, Master/Slave, PAR. 3.2.14), UTIL (utility, PAR. 3.2.17). or EXIT. To select a function, tap DC OUTPUT.

How do I view/change the virtual model settings? See PAR. 3.2.9 for description of virtual model. *If status shows SET, exit setpoint mode (tap either knob once).* Use thin tool to press FUNCTION once; status reads VIRT. VOLTS and AMPS displays show the maximum voltage and current of the present virtual model. *If no change, exit function mode (see above).* To change, press DC OUTPUT once. Status shows PASS (password). Enter password (*see above*) and tap DC OUTPUT to accept. When password is accepted, status reads VIRT, VOLTS and AMPS displays blink. To change setting rotate Voltage and Current knobs until VOLTS and AMPS displays show desired virtual model settings. (Press and hold knob in while turning for fine adjustment.) Press DC OUTPUT to accept virtual model settings. Unit displays DONE, then resets and repeats power on sequence.

How do I view/change overvoltage and overcurrent protection limits? See PAR.3.2.11 for description of protection limits. *If status reads SET, tap either knob to exit setpoint mode.* To view protection limits, use a thin tool to press and hold PROTECT until status reads PROT, VOLTS and AMPS displays show the protection limits; to change limits, while continuing to hold PROTECT in, adjust OVP and OCP limits using the Voltage and Current knobs. When PROTECT released, values showing in VOLTS and AMPS displays are the new protection limits.

REMOTE ANALOG OPERATING MODE INSTRUCTIONS

How do I enable analog operating mode? Connect ANALOG_CTRL (pin 12) to GROUND (pin 9, 11, 13, or 15) of analog port prior to power-up to enable remote analog programming for that session. Remote analog control is indicated by "aREM" in status display. *The status of ANALOG_CTRL is sensed at power-up only.* Enabling analog operating mode disables the local operating controls on the front panel. (see PAR. 3.4).

How do I enable or disable the output? Connect REM_INH (pin 8) to GROUND (pin 9, 11, 13, or 15) of analog port to disable power supply output, open the connection to enable the output (see PAR. 3.2.6). The DC OUTPUT control on the front panel remains active in remote analog programming mode. REM_INH can be configured as active for either TTL high or low (see PAR. 3.2.17.3.1).

How do I adjust voltage and current setpoints using an external voltage source? Set analog I/O DIP switch positions 1 and 2 up (factory default position) to use external voltage control of voltage and current, respectively. Full-scale programming voltage is factory set at 10V; to alter full-scale value see PAR. 3.2.17.4. Apply a 0-10V signal from Vref (pin 1) and Cref (pin 3) to GROUND (pin 9, 11, 13, or 15) of analog port to adjust the setpoint values for output voltage and current proportionally between minimum and maximum virtual model limits. *Programming input pins are only active when analog port is enabled.* (See PAR. 3.4.2 for details.)

How do I adjust voltage and current setpoints using an external resistance? Set analog I/O DIP switch positions 1 and 2 down to use external resistance for remote analog programming of voltage and current, respectively. Full-scale programming resistance is factory set at 10KOhms; to alter full-scale value see PAR. 3.2.17.4 and use 1000 ohms per volt scale factor. Apply a 0-10KOhm resistance from Vref (pin 1) and Cref (pin 3) to GROUND (pin 9, 11, 13, or 15) of analog port to adjust the setpoint values for output voltage and current proportionally between minimum and maximum virtual model limits. *Programming inputs are only active when analog port is enabled.* (See PAR. 3.4.1 for details.)

How do I Read back operating voltage and current? Analog signals proportional to actual output voltage and current levels are available at VOLT_RBACK (pin 6) and CURR_RBACK (pin 7) of analog I/O port. Full-scale signal level is the same as that for full scale programming. Readback signals are always available at analog port, even if analog programming is not enabled.

How do I exit remote analog programming mode? Simultaneously depressing and releasing both Voltage and Current knobs forces the unit to exit remote analog programming mode and return to local operating mode; this can also be done by sending any command or query via the remote digital inputs. To restore remote analog control cycle source power OFF for five seconds then restart.

REMOTE DIGITAL OPERATING MODE INSTRUCTIONS

How do I enable digital operating mode? Sending any digital command or query via either the GPIB, LAN or RS 232 port immediately sets the unit in remote digital operating mode and disables the local operating controls on the front panel. For details on command formatting and communication protocols see PAR. 3.3.

How do I exit remote digital programming mode? Simultaneously depressing and releasing both Voltage and Current knobs will force the unit to exit remote digital programming mode and return to local operating mode. Remote digital control is reactivated upon transmission of any digital command or query by the control (host) computer.

How do I view/change the GPIB address? The factory default GPIB address is 6. Using a thin tool, press FUNCTION once; status reads VIRT. Rotate Voltage or Current knob until status reads ADDR; the active GPIB address shows in AMPS display. To exit, rotate Voltage or Current knob till status reads EXIT then tap DC OUTPUT. To change, tap DC OUTPUT: AMPS display blinks. Rotate Current knob to change address and tap DC OUTPUT to accept; display flashes DONE then ADDR. See above to exit.

How do I view/change RS 232 baud rate? [standard models Only] The factory default RS 232 baud rate is 38400. Using a thin tool, press FUNCTION once; status reads VIRT. Rotate Voltage or Current knob until status reads BAUD; AMPS display shows active baud rate x 1000 (e.g., 38400 is displayed as 38.4). To exit, rotate Voltage or Current knob till status reads EXIT then tap DC OUTPUT. To change, tap DC OUTPUT: AMPS display blinks. Rotate Current knob to change baud rate and tap DC OUTPUT to accept; display flashes DONE then BAUD. See above to exit. See PAR. 3.3.1.2 for additional RS 232 parameters.

How do I set up the LAN interface? [E-Series models only] See PAR. 3.2.15 and refer to KLP Developer's Guide.

How do I operate the KLP using web pages via the LAN interface? [E-Series models only] See PAR. 3.3.6 and refer to KLP Developer's Guide. Use the PSfind program available at www.kepcopower.com/utility to locate KLP(s) functioning on the LAN. Highlight the unit and click Launch Web Page. Click OPERATE INSTRUMENT. Simulated front panel shows status of voltage, current, output on/off, and operating mode (CV or CC). Operating functions supported from Operate Instrument page: Set output on/off and output voltage/current (PAR. 3-7), overvoltage/overcurrent protection (PAR. 3-7), save/recall (PAR. 3.3.6.6.3), reset (PAR. 3.3.6.6.4), list (PAR. 3.3.6.6.5) and virtual model (PAR. 3.3.6.6.6). Click CONFIGURE LAN to view LAN addresses (PAR. 3.3.6.4). Click ID INSTRUMENT to flash physical LAN indicator on KLP.