

# OPERATOR'S MANUAL

## BOP-MG/MGL/ME/MEL 2KW

### HIGH POWER BIPOLAR POWER SUPPLY

KEPCO INC.  
An ISO 9001 Company.

MODEL CE  
**BOP-MG/MGL/ME/MEL**  
**2KW**  
**POWER SUPPLY**

ORDER NO.

#### IMPORTANT NOTES:

- 1) This manual is valid for the following Firmware Versions:

FIRMWARE VERSION	NOTE.
7.0 and higher	
  
- 2) A Change Page may be included at the end of the manual. All applicable changes and revision number changes are documented with reference to the equipment serial numbers. Before using this Instruction Manual, check your equipment firmware version number to identify your model. If in doubt, contact your nearest Kepco Representative, or the Kepco Documentation Office in New York, (718) 461-7000, requesting the correct revision for your particular model and firmware version number.
  
- 3) The contents of this manual are protected by copyright. Reproduction of any part can be made only with the specific written permission of Kepco, Inc.

Data subject to change without notice.

©2019, KEPCO, INC  
P/N 243-1402-r1





## Conditions of Conformance

When this product is used in applications governed by the requirements of the EEC, the following restrictions and conditions apply:

1. For European applications, requiring compliance to the Low Voltage Directive, 73/23/EEC, this power supply is considered a component product, designed for "built in" applications. Because it is incomplete in construction, the end product enclosure must provide for compliance to any remaining electrical safety requirements and act as a fire enclosure. (EN61010-1 Cl. 6, Cl. 7, Cl.8, Cl. 9 and EN61010-1 annex F)
2. This power supply is designed for stationary installation, with mains power applied via a detachable power supply cord or via direct wiring to the source power terminal block.
3. This power supply is considered a Class 1 (earthed) product, and as such depends upon proper connection to protective earth for safety from electric shock. (EN61010-1 Cl. 6.5.4)
4. This power supply is intended for use as part of equipment meant for test, measurement and laboratory use, and is designed to operate from single phase, three wire power systems. This equipment must be installed within a suitably wired equipment rack, utilizing a three wire (grounded) mains connection. See wiring section of this manual for complete electrical wiring instructions. (EN61010-1 Cl. 6.5.4 and Cl.6.10.1)
5. This power supply has secondary output circuits that are considered hazardous, and which exceed 100V d-c, able to deliver current greater than 10A d-c.
6. The output wiring terminals of this power supply have not been evaluated for field wiring and, therefore, must be properly configured by the end product manufacturer prior to use.
7. This power supply employs a supplementary circuit protector in the form of a circuit breaker mounted on the front panel. This circuit breaker protects the power supply itself from damage in the event of a fault condition. For complete circuit protection of the end product, as well as the building wiring, it is required that a primary circuit protection device be fitted to the branch circuit wiring. (EN61010-1 Cl. 9.6.2)
8. Hazardous voltages are present within this power supply during normal operation. All operator adjustments to the product are made via externally accessible switches, controls and signal lines as specified within the product operating instructions. There are no user or operator serviceable parts within the product enclosure. Refer all servicing to qualified and trained Kepco service technicians.

# SAFETY INSTRUCTIONS

## 1. Installation, Operation and Service Precautions

This product is designed for use in accordance with EN 61010-1 and UL 3101 for Installation Category 2, Pollution Degree 2. Hazardous voltages are present within this product during normal operation. The product should never be operated with the cover removed unless equivalent protection of the operator from accidental contact with hazardous internal voltages is provided:



There are no operator serviceable parts or adjustments within the product enclosure. Refer all servicing to trained service technician.



Source power must be removed from the product prior to performing any servicing.



This product is factory-wired for the nominal a-c mains voltage indicated on the rating nameplate located adjacent to the source power connection on the product's rear panel. To reconfigure the product input for other nominal mains voltages as listed herein, the product must be modified by a trained service technician.

## 2. Grounding

This product is a Class 1 device which utilizes protective earthing to ensure operator safety.



The PROTECTIVE EARTHING CONDUCTOR TERMINAL must be properly connected prior to application of source power to the product (see instructions on installation herein) in order to ensure safety from electric shock.



PROTECTIVE EARTHING CONDUCTOR TERMINAL - This symbol indicates the point on the product to which the protective earthing conductor must be attached.



EARTH (GROUND) TERMINAL - This symbol is used to indicate a point which is connected to the PROTECTIVE EARTHING TERMINAL. The component installer/ assembler must ensure that this point is connected to the PROTECTIVE EARTHING TERMINAL.

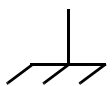

CHASSIS TERMINAL - This symbol indicates frame (chassis) connection, which is supplied as a point of convenience for performance purposes (see instructions on grounding herein). This is not to be confused with the protective earthing point, and may not be used in place of it.

## 3. Electric Shock Hazards

This product outputs hazardous voltage and energy levels as a function of normal operation. Operators must be trained in its use and exercise caution as well as common sense during use to prevent accidental shock.



This symbol appears adjacent to any external terminals at which hazardous voltage levels as high as 500V d-c may exist in the course of normal or single fault conditions.



This symbol appears adjacent to any external terminals at which hazardous voltage levels in excess of 500V d-c may exist in the course of normal or single fault conditions.

# OPERATOR SAFETY INSTRUCTIONS

Read these safety instructions, as well as the applicable installation and operating instructions contained in this manual before using the power supply.





Do not touch the output terminals. The output is dangerous. Electric shock can cause injury or death.

Do not remove the cover or disassemble the unit. There are no operator serviceable components or adjustments inside the unit. High voltage components inside the unit can cause serious injury even with input power disconnected.

Service must be referred to authorized personnel. Using the power supply in a manner not specified by Kepco, Inc. may impair the protection provided by the power supply. Observe all safety precautions noted throughout this manual. The following table lists symbols used on the power supply or in this manual where applicable.

The liquid in the LCD is hazardous: do not lick or swallow. Wash skin and clothes immediately and thoroughly upon exposure.

## SAFETY SYMBOLS

SYMBOL	Meaning
	WARNING: RISK OF ELECTRIC SHOCK. INDICATES THE POSSIBILITY OF BODILY INJURY OR DEATH.
	CAUTION: REFER TO REFERENCED PROCEDURE. INDICATES THE POSSIBILITY OF EQUIPMENT DAMAGE.



## CAUTION

If this power supply is used in OEM equipment, the OEM equipment manufacturer is responsible for attaching appropriate warning labels on the OEM equipment.

Operating the power supply outside the specified limits for input voltage, temperature, or other environmental conditions noted in this manual can damage the power supply and void the warranty.

DO NOT: wipe the front panel with hard materials, nor apply excessive force to the surface. DO NOT expose to extended periods of bright sunshine or UV light.

## Safety Messages

The BOP protection circuitry is designed to protect the load against unregulated high voltages and protect the BOP from extensive damage in the event of a component failure. Refer to Table 1-2 for more information regarding the protection circuits.



# LIST OF WARNINGS AND CAUTIONS

PAGE	WARNING/CAUTION
2-14	<b>WARNING:</b> This feature requires disassembly and modification of the unit and implementation is permitted only by authorized service personnel.
3-24	<b>WARNING:</b> For inductive loads, and especially superconducting magnet type loads, the inherent offset of the BOP in the OFF state may generate significant current in the circuit. Two properly rated external switches must be installed for safety: one in series between the power supply and the magnet, and the other in parallel with the magnet. Once the BOP front panel display reads 0V, 0A, close the parallel switch, then open the series switch before removing or installing connections between BOP and load. To restore normal operation, first close the series switch, then open the parallel switch.
3-24	<b>WARNING:</b> For both inductive loads and constant-current-type active electronic loads when the BOP output is set to OFF, a path is provided for absorbing either the energy accumulated in the reactance of the load during the ON state, or energy delivered by an electronic load. This prevents damage to the load and power supply as well as providing safety for the user. However, In addition to the built-in safety features, constant-current-type active electronic loads must be adjusted to zero and the BOP front panel LCD must read 0V, minimum current, before handling the power supply-to-load connections.
3-25	<b>WARNING:</b> Accessing the BOP after the output is disabled in BATTERY mode is hazardous because (1) high current arcing is possible and (2) either the external battery voltage, or the voltage ( $\pm$ Voltage Protection max) on the BOP output terminals may be dangerous. Therefore, for battery and constant-voltage-type active electronic loads it is recommended that two properly rated external switches be installed for safety: one in series with the battery, and one across the BOP output. After the unit is set to OFF, first open the switch in series with the battery, then close the switch across the BOP output to ensure safety before handling BOP connections. When connecting the battery, the switch across the output should be opened after the connections are complete and then the switch in series with the battery should be closed. If the constant-voltage-type active electronic load is adjusted to zero before handling the power supply-to-load connections, only the switch across the BOP output is required.
3-41	<b>WARNING:</b> Be sure that output power is OFF (Standby indicator lit) while connecting monitoring device. Be sure that connections are secure and that terminals are not inadvertently shorted.
3-45	<b>WARNING:</b> Dangerous voltages are present at the output terminals: Do not touch! Disconnect load before running this test.
4-8	<b>WARNING:</b> The sense resistor will be dissipating full rated current of the BOP. If it is hot to the touch, the sense resistor value, power rating and/or cooling are incorrect; refer to PAR. 4.3 and Table 4-2.
4-13	<b>WARNING:</b> The sense resistor will be dissipating full rated current of the BOP. If it is hot to the touch, the sense resistor value, power rating and/or cooling are incorrect; refer to PAR. 4.4 and Table 4-2.

# LIST OF WARNINGS AND CAUTIONS

PAGE	WARNING/CAUTION
2-5	<b>CAUTION:</b> it is recommended that source power of external equipment connected to the Analog Port be applied through an isolating transformer to avoid ground loops or possible damage to the BOP due to incorrect equipment a-c wiring (e.g., defeating of ground connection).
2-8	<b>CAUTION:</b> When working with active loads, the voltage or current of the active load must not exceed the maximum voltage or current rating of the BOP. Otherwise the overvoltage or overcurrent protection will shut down the power supply.
2-9	<b>CAUTION:</b> Never connect the both the load terminal tied to the BOP COM terminal and the programming device common to earth-ground. This allows a ground loop current to flow within the BOP which will compromise accuracy. Catastrophic damage to the BOP will result if the connection between BOP COM and the load terminal connected to earth-ground is lost.
2-10	<b>CAUTION:</b> Never connect the load to the sense terminals. Monitoring instruments (e.g., DVM, etc.) are the only external equipment that may be safely connected to the sense terminals.
2-10	<b>CAUTION:</b> Never connect the both the load terminal tied to the BOP COM terminal and the programming device common to earth-ground. This allows a ground loop current to flow within the BOP which will compromise accuracy. Catastrophic damage to the BOP will result if the connection between BOP COM and the load terminal connected to earth-ground is lost.
2-10	<b>CAUTION:</b> The safety features incorporated into the BOP to handle energy from Active loads are unable to protect the power supply or the load if input power to the BOP is lost or if the BOP malfunctions. It is recommended that the user monitor "Power OK" flag pins 3 and 4 of the external Protect Port (see Table 2-6) and implement a fast-acting means of disconnecting capacitive loads or crowbarring inductive loads to prevent damage to both the BOP and the load in the event of input power loss.
2-15	<b>CAUTION:</b> To ensure correct operation, do not remove the GPIB cable from the BOP after a Query is processed. Ensure that the last command is a non-query such as *CLS before removing the GPIB cable. Otherwise, power to the BOP and/or the host computer may need to be cycled OFF then ON to restore proper operation.
3-4	<b>CAUTION:</b> Pressing RESET will cause voltage transients to appear at the output which may damage a connected load.
3-7	<b>CAUTION:</b> DO NOT repeatedly toggle the circuit breaker/switch as this may damage the unit.
3-16	<b>CAUTION:</b> When the ADJUST control is rotated, the active parameter is immediately effective if the output is enabled (on = STANDBY indicator not lit). The voltage/current applied to the load changes as the ADJUST control is rotated.
3-22	<b>CAUTION:</b> When working with active loads, always adjust the BOP protection limits to be above the maximum values of voltage or current expected from the load. For example, when the BOP is operating in voltage mode sinking energy from a constant current type load, set the current protection limits of the BOP above the maximum current expected from the load.

# LIST OF WARNINGS AND CAUTIONS

PAGE	WARNING/CAUTION
3-25	<b>CAUTION:</b> When working with battery mode, if the output is set to ON by *RST (see PAR. 3.5.3.3) and the battery is charged above 0.01V, the unit will sink 105% of $I_{Omax}$ .
3-33	<b>CAUTION:</b> Before Pressing  to enter the Saved Waveform Screen from the power-up screen, perform the following steps to avoid unexpected voltages or currents from previous settings being briefly applied to the load when the waveform is first executed.
3-44	<b>CAUTION:</b> Pressing RESET will cause voltage transients to appear at the output which may damage a connected load. Switch is recessed to prevent inadvertent activation.
3-56	<b>CAUTION:</b> The commands listed above with (**) will generate a “-440, Missing Query” error if a query does not precede the command in the same command string or ; *OPC? does not follow the command. Although commands not marked with (**) will not generate an error, all commands listed above require verification to insure absolute success. Failure to follow these rules can result in the loss of all stored constants and render the unit inoperative.
3-63	<b>CAUTION:</b> To ensure correct operation, do not remove the GPIB cable from the BOP after a Query is processed. Ensure that the last command is a non-query such as *CLS before removing the GPIB cable. Otherwise, power to the BOP and/or the host computer may need to be cycled OFF then ON to restore proper operation.
3-67	<b>CAUTION:</b> When the serial port has received an XOFF, the error message “-400, Query Error” will be placed in the queue to indicate the loss of transmitted information due to a received XOFF character. When XON is received, the unit will transmit all data in it's buffer followed by the exclamation character (!). This (!) character is not part of any message from the BOP and indicates the transmission buffer has been cleared and the BOP is idle.
4-5	<b>CAUTION:</b> Sending commands other than SYST:ERR? during calibration will adversely affect calibration of the unit.
4-11	<b>CAUTION:</b> If the CALIBRATE ZERO  function is available, perform this function first, as it affects all other output calibrations.



# TABLE OF CONTENTS

SECTION	PAGE
<b>SECTION 1 - INTRODUCTION</b>	
1.1	Scope of Manual ..... 1-1
1.2	General Description..... 1-1
1.2.1	LXI Compatibility (ME Models) ..... 1-2
1.3	Specifications ..... 1-2
1.4	Local Control ..... 1-14
1.5	Remote Control ..... 1-14
1.6	Features ..... 1-16
1.6.1	Digital Calibration..... 1-16
1.6.2	voltage/current Protection..... 1-16
1.6.3	Waveforms..... 1-16
1.6.4	Saving and Recalling Settings ..... 1-16
1.6.5	External Reference (Analog Control)..... 1-16
1.6.6	External Limits ..... 1-17
1.6.7	User-defined Voltage/Current Maximum Values (Software Limits) ..... 1-17
1.6.8	Energy Recuperation ..... 1-17
1.7	Equipment Supplied ..... 1-17
1.8	Accessories ..... 1-18
1.9	Safety ..... 1-19
<b>SECTION 2 - INSTALLATION</b>	
2.1	Unpacking and Inspection ..... 2-1
2.2	Terminations and Controls ..... 2-1
2.3	Preliminary Operational Check..... 2-6
2.4	Installation ..... 2-7
2.5	Wiring Instructions ..... 2-8
2.5.1	Safety Grounding..... 2-8
2.5.2	Source Power Connections ..... 2-8
2.5.3	D-C Output Grounding..... 2-8
2.5.3.1	Earth-Ground Configuration..... 2-9
2.5.4	Power Supply/Load Interface..... 2-9
2.5.5	Load Connection - General..... 2-10
2.5.6	Load Connection Using Local Sensing..... 2-12
2.5.7	Load Connection Using Remote Sensing..... 2-12
2.6	Cooling ..... 2-12
2.7	Setting up the unit ..... 2-12
2.7.1	Consider the Load Type ..... 2-12
2.7.2	Setup for Local Operation..... 2-12
2.7.3	Setup for Fail Safe/Interlock PROTECTION..... 2-14
2.7.4	Setup for Remote Operation via GPIB (MG Models Only) ..... 2-14
2.7.5	Setup for Remote Operation via RS 232C..... 2-15
2.7.6	Setup for Remote Operation via LAN (ME Models Only) ..... 2-15
2.7.6.1	Finding Kepco Power Supplies on the LAN..... 2-15
2.7.6.2	Bonjour-enabled Discovery..... 2-16
2.7.6.3	LXI Discovery..... 2-16
2.7.6.4	Launch Web Interface..... 2-17
2.7.6.5	LAN Configuration Using Web Interface ..... 2-18
<b>SECTION 3 - OPERATION</b>	
3.1	General..... 3-1
3.2	Power Supply Basics..... 3-1
3.2.1	Keypad Description..... 3-3
3.2.2	LCD and Power-up Screen Description..... 3-5
3.2.3	Turning the Power Supply On..... 3-7
3.2.4	How to Access the menus ..... 3-8
3.2.4.1	How to Modify a Parameter ..... 3-9

# TABLE OF CONTENTS

SECTION	PAGE
3.2.4.2	Password Setup..... 3-10
3.2.4.3	How to Access a Password Protected Menu ..... 3-11
3.2.5	Display Settings (Operator Convenience) Menu..... 3-12
3.2.5.1	Displaying Meters or Graph (Time line) ..... 3-13
3.2.5.2	Adjusting LCD contrast and Background ..... 3-13
3.2.5.3	Waveform Stop ..... 3-13
3.2.5.4	Enabling/Disabling Audible Beeps ..... 3-13
3.3	Local Mode Operation ..... 3-13
3.3.1	Setting Local Mode ..... 3-13
3.3.1.1	Keypad Lockout ..... 3-15
3.3.1.2	Local Password Protection at Power-up ..... 3-15
3.3.2	Setting Voltage or Current Mode ..... 3-15
3.3.3	Programming Voltage or Current and Associated Protect Limits..... 3-15
3.3.3.1	Selecting Bipolar/Independent Protection Limits..... 3-17
3.3.3.2	Understanding Voltage and Current Protect Limits..... 3-18
3.3.3.3	Hidden Voltage and Current Protect Limits..... 3-19
3.3.4	Changing Maximum or Minimum Software-controlled Limits..... 3-19
3.3.4.1	Changing Maximum Accepted Voltage or Current (Main Channel Software Limits)..... 3-20
3.3.4.2	Changing Maximum/Minimum Protection Software-controlled Limits ..... 3-22
3.3.4.3	External Limits..... 3-22
3.3.5	Enabling/Disabling DC Output Power ..... 3-23
3.3.6	Using the Trigger Port to Customize Output On/Off Operation..... 3-23
3.3.7	Determining How the Unit responds when Output is OFF (Load Type)..... 3-23
3.3.7.1	Battery Charging/Discharging using the BOP ..... 3-26
3.3.7.1.1	Battery Operations using Voltage Mode..... 3-26
3.3.7.1.2	Battery Operations using Current Mode ..... 3-26
3.3.8	Changing the Default Power up Settings ..... 3-27
3.3.9	Storing/Recalling Power Supply Output Settings..... 3-29
3.3.9.1	Understanding Abbreviations Used for Saved Settings ..... 3-30
3.3.9.2	Viewing Saved Settings ..... 3-30
3.3.9.3	Saving Settings and Erasing or Modifying Previously Saved settings ..... 3-32
3.3.9.4	Copying Previously Saved settings to a New Location ..... 3-33
3.3.9.5	Applying Saved settings to the Output (Recall)..... 3-33
3.3.10	Waveform Generation..... 3-33
3.3.10.1	Protecting the Load When Accessing Waveforms ..... 3-33
3.3.10.2	Waveform Overview ..... 3-33
3.3.10.3	Understanding How Waveforms Are Generated..... 3-34
3.3.10.4	Waveform Specifications..... 3-36
3.3.10.5	Viewing Stored Waveforms..... 3-36
3.3.10.6	Creating a New Waveform ..... 3-36
3.3.10.7	Executing a Waveform ..... 3-40
3.3.10.8	Modifying Previously Stored Waveforms ..... 3-41
3.3.10.9	Using Segments to Build a Waveform ..... 3-41
3.3.10.10	Copying a Waveform..... 3-44
3.3.11	Reset..... 3-44
3.3.12	Operator Testing..... 3-44
3.3.13	Error Message Explanations..... 3-45
3.4	Analog Remote Mode Programming ..... 3-47
3.4.1	Suppressing Noise at the Output..... 3-47
3.4.2	Remote Output off..... 3-47
3.4.2.1	Remote Shutdown..... 3-47
3.4.2.2	Remote Standby ..... 3-48
3.4.3	Voltage/Current Mode Control ..... 3-48
3.4.4	Controlling the Output Using the BOP as a Power Amplifier ..... 3-49
3.4.4.1	Fixed Gain using External Reference Control ..... 3-49
3.4.4.2	Variable Gain Using External Reference Level ..... 3-50
3.4.5	External Protection Limits ..... 3-51

# TABLE OF CONTENTS

SECTION	PAGE
3.4.5.1	Using Both Local/Digital and External Protection Limits ..... 3-52
3.4.6	Monitoring Output Current Using an analog signal ..... 3-52
3.5	Digital Remote Mode Programming ..... 3-52
3.5.1	Operating Features Available only by Remote Commands ..... 3-53
3.5.1.1	Measurement Capabilities ..... 3-53
3.5.1.2	Maximum Setpoint to Measurement Response ..... 3-53
3.5.1.2.1	New or Modified Commands: ..... 3-53
3.5.1.2.2	Power-up Defaults ..... 3-54
3.5.1.2.3	How to Implement MAXimum Setpoint to Measurement Specification ..... 3-54
3.5.2	Programming Techniques to Optimize performance ..... 3-55
3.5.2.1	Programming Voltage/Current Limit and Current/Voltage Limit ..... 3-55
3.5.2.2	Making Sure the Previous Command is Complete ..... 3-55
3.5.3	Remote Mode Setup ..... 3-56
3.5.3.1	Determining Whether *RST Command sets the Output Off or On ..... 3-57
3.5.3.2	GPIB Port Setup (MG Models ONLY) ..... 3-58
3.5.3.2.1	Changing the GPIB Address ..... 3-58
3.5.3.2.2	Establish Communication Language ..... 3-59
3.5.3.2.3	Configure Device Clear (DCL) Control ..... 3-59
3.5.3.3	RS 232 Serial Port Setup ..... 3-59
3.5.3.3.1	Select Baud Rate ..... 3-59
3.5.3.3.2	Configure XON/XOFF Protocol ..... 3-59
3.5.3.3.3	Configure Prompt Mode ..... 3-59
3.5.3.4	LAN Interface Setup (ME Models Only) ..... 3-60
3.5.3.4.1	Set IP Address ..... 3-61
3.5.3.4.2	Change IP Address Mask ..... 3-61
3.5.3.4.3	Configure Auto IP ..... 3-61
3.5.3.4.4	Configure DHCP ..... 3-61
3.5.3.4.5	Configure Host Name ..... 3-61
3.5.3.4.6	Configure Index ..... 3-62
3.5.3.5	BIT 4882 Compatibility ..... 3-62
3.5.3.6	BIT 4886 Compatibility ..... 3-62
3.5.3.6.1	LIST Command Differences in BIT 4886 ..... 3-62
3.5.3.6.2	Status Reporting Differences in BIT 4886 ..... 3-63
3.5.3.6.3	Trigger Operation Differences in BIT 4886 ..... 3-63
3.5.4	IEEE 488 (GPIB) Bus Protocol (MG Models Only) ..... 3-63
3.5.5	BOP VISA Instrument driver ..... 3-65
3.5.6	RS232-C Operation ..... 3-65
3.5.6.1	Serial Interface ..... 3-65
3.5.6.2	RS 232 Implementation ..... 3-66
3.5.6.2.1	XON XOFF Method ..... 3-68
3.5.6.2.2	Echo Mode ..... 3-68
3.5.6.2.3	Prompt Method ..... 3-68
3.5.6.3	Using SCPI commands for RS 232 Communication ..... 3-68
3.5.6.4	Isolating RS 232 Communication Problems ..... 3-69
3.5.7	LAN Operation (ME Models Only) ..... 3-69
3.5.7.1	LAN Factory Defaults ..... 3-69
3.5.7.2	Remote Programming Using the Web Interface ..... 3-70
3.5.7.3	Troubleshooting LAN Communication Problems ..... 3-70
3.5.7.4	Launch Web Interface ..... 3-71
3.5.7.5	LAN Configuration Using Web Interface ..... 3-72
3.5.7.6	Operating The Unit Using Web Interface ..... 3-74
3.5.7.6.1	Changing the Output ..... 3-74
3.5.7.6.2	Resetting the Unit (*RST) ..... 3-75
3.5.7.6.3	Using a Waveform (User-Programmed Sequences) ..... 3-75
3.6	SCPI Programming ..... 3-77
3.6.1	SCPI Messages ..... 3-77
3.6.2	Common Commands/Queries ..... 3-77

# TABLE OF CONTENTS

SECTION	PAGE
3.6.3	SCPI Subsystem Command/Query Structure..... 3-77
3.6.3.1	ABORt Subsystem ..... 3-77
3.6.3.2	INITiate Subsystem..... 3-77
3.6.3.3	LIST Subsystem..... 3-78
3.6.3.4	MEASure Subsystem ..... 3-78
3.6.3.5	OUTPut Subsystem ..... 3-78
3.6.3.6	MEMory Subsystem ..... 3-80
3.6.3.7	STATus Subsystem ..... 3-81
3.6.3.8	TRIGger subsystem ..... 3-81
3.6.3.9	[SOURce:]VOLTage and [SOURce:]CURRent Subsystems ..... 3-81
3.6.3.10	CALibrate Subsystem ..... 3-82
3.6.3.11	System Subsystem ..... 3-82
3.6.3.11.1	Forgotten Passwords ..... 3-82
3.6.4	Program Message Structure ..... 3-82
3.6.4.1	Keyword ..... 3-83
3.6.4.2	Keyword Separator ..... 3-84
3.6.4.3	Query Indicator..... 3-84
3.6.4.4	Data..... 3-84
3.6.4.5	Data Separator..... 3-84
3.6.4.6	Message Unit Separator ..... 3-84
3.6.4.7	Root Specifier..... 3-85
3.6.4.8	Message Terminator ..... 3-85
3.6.5	Understanding The Command Structure ..... 3-85
3.6.6	Program Message Syntax Summary ..... 3-86
3.6.7	Status Reporting ..... 3-87
3.6.7.1	Status Reporting Structure ..... 3-87
3.6.7.2	Operational Status Register ..... 3-87
3.6.7.3	QUEStionable Status Register ..... 3-89
3.6.8	SCPI Program Examples..... 3-90

## SECTION 4 - CALIBRATION

4.1	General..... 4-1
4.2	Test Equipment Requirements ..... 4-2
4.3	Calibration using Remote SCPI commands via GPIB or RS 232 Interface ..... 4-5
4.3.1	Calibration Procedure using SCPI Commands..... 4-5
4.4	Calibration Using Front Panel Keypad in Local Mode ..... 4-9
4.4.1	Understanding the Calibration Process ..... 4-10
4.4.2	Calibration Procedure using Local Mode ..... 4-11
4.5	Calibration Storage ..... 4-15

## APPENDIX A - SCPI COMMON COMMAND/QUERY DEFINITIONS

A.2	*CLS — Clear Status Command ..... A-1
A.3	*ESE — Standard Event Status Enable Command..... A-1
A.4	*ESE? — Standard Event Status Enable Query..... A-2
A.5	*ESR? — Event Status Register Query..... A-2
A.6	*IDN? — Identification Query..... A-2
A.7	*OPC — Operation Complete Command ..... A-2
A.8	*OPC? — Operation Complete Query ..... A-3
A.9	*OPT? — Options Query ..... A-4
A.10	*RCL — Recall Command ..... A-4
A.11	*RST — Reset Command..... A-4

# TABLE OF CONTENTS

SECTION		PAGE
A.12	*SAV — Save Command .....	A-5
A.13	*SRE — Service Request Enable Command .....	A-5
A.14	*SRE? — Service Request Enable Query .....	A-5
A.15	*STB? — Status Byte Register Query .....	A-5
A.16	*TRG — Trigger Command .....	A-6
A.17	*TST? — Self Test Query .....	A-6
A.18	*WAI — Wait-To-Continue Command .....	A-6

## APPENDIX B - SCPI COMMAND/QUERY DEFINITIONS

B.1	Introduction .....	B-1
B.2	Numerical Values .....	B-3
B.3	ABORt Command .....	B-3
B.4	CAL Commands and Queries .....	B-3
B.5	INITiate[:IMMEDIATE] Command .....	B-3
B.6	INITiate:CONTInuous Command .....	B-4
B.7	INITiate:CONTInuous? Query .....	B-4
B.8	MEASure? Query .....	B-5
B.9	MEASure:CURRent? Query .....	B-5
B.10	MEASure:MODE Command .....	B-5
B.11	MEASure:MODE? Query .....	B-5
B.12	MEASure:RATE Command .....	B-5
B.13	MEASure:RATE? Query .....	B-6
B.14	MEASure:VOLTage? Query .....	B-6
B.15	MEASure:TRANSient? QUERY .....	B-6
B.16	MEMory:LIST? QUERY .....	B-6
B.17	MEMory:LOCation Command .....	B-6
B.18	MEMory:LOCation? Query .....	B-7
B.19	MEMory:PACK Command .....	B-8
B.20	MEMory:UPDate Command .....	B-8
B.21	OUTPut[:STATe] Command .....	B-8
B.22	OUTPut[:STATe] Query .....	B-9
B.23	OUTPut:CONTrol Command .....	B-10
B.24	OUTPut:CONTrol? Query .....	B-11
B.25	OUTPut:MODE Command .....	B-11
B.26	OUTPut:MODE? Query .....	B-11
B.27	[SOURce:]CURRent[:LEVel][:IMMEDIATE][:AMPLitude] Command .....	B-11
B.28	[SOURce:]CURRent[:LEVel][:IMMEDIATE][:AMPLitude] Query .....	B-11
B.29	[SOURce:]CURRent[:LEVel]:LIMit[:BOTH] Command .....	B-11
B.30	[SOURce:]CURRent[:LEVel]:LIMit[:BOTH]? Query .....	B-11
B.31	[SOURce:]CURRent[:LEVel]:LIMit:NEG Command .....	B-12
B.32	[SOURce:]CURRent[:LEVel]:LIMit:NEG? Query .....	B-12
B.33	[SOURce:]CURRent[:LEVel]:LIMit:POS Command .....	B-12
B.34	[SOURce:]CURRent[:LEVel]:LIMit:POS? Query .....	B-12
B.35	[SOURce:]CURRent:MODE Command .....	B-12
B.36	[SOURce:]CURRent:MODE? Query .....	B-13
B.37	[SOURce:]CURRent[:LEVel]:PROTect[:BOTH] Command .....	B-13
B.38	[SOURce:]CURRent[:LEVel]:PROTect[:BOTH] Query .....	B-14
B.39	[SOURce:]CURRent[:LEVel]:PROTect:MODE Command .....	B-14
B.40	[SOURce:]CURRent[:LEVel]:PROTect:MODE? Query .....	B-14
B.41	[SOURce:]CURRent[:LEVel]:PROTect:NeGative Command .....	B-14
B.42	[SOURce:]CURRent[:LEVel]:PROTect:NeGative? Query .....	B-14
B.43	[SOURce:]CURRent[:LEVel]:PROTect:POSitive Command .....	B-14
B.44	[SOURce:]CURRent[:LEVel]:PROTect:POSitive? Query .....	B-14
B.45	[SOURce:]CURRent[:LEVel]:PROTect:LIMit[:BOTH] Command .....	B-15
B.46	[SOURce:]CURRent[:LEVel]:PROTect:LIMit[:BOTH]? Query .....	B-15

## TABLE OF CONTENTS

SECTION	PAGE
B.47	[SOURCE:]CURRENT[:LEVEL]:PROTECT:LIMIT:NEGATIVE Command ..... B-15
B.48	[SOURCE:]CURRENT[:LEVEL]:PROTECT:LIMIT:NEGATIVE? Query ..... B-15
B.49	[SOURCE:]CURRENT[:LEVEL]:PROTECT:LIMIT:POSITIVE Command ..... B-15
B.50	[SOURCE:]CURRENT[:LEVEL]:PROTECT:LIMIT:POSITIVE? Query ..... B-15
B.51	[SOURCE:]CURRENT[:LEVEL]:TRIGGERED[:AMPLITUDE] Command ..... B-16
B.52	[SOURCE:]CURRENT[:LEVEL]:TRIGGERED[:AMPLITUDE]? Query ..... B-16
B.53	[SOURCE:]FUNCTION:MODE Command ..... B-16
B.54	[SOURCE:]FUNCTION:MODE? Query ..... B-16
B.55	[SOURCE:]FUNCTION:MODE:TRIGGER Command ..... B-16
B.56	[SOURCE:]FUNCTION:MODE:TRIGGER? Query ..... B-16
B.57	[SOURCE:]LIST:CLEAR Command ..... B-16
B.58	[SOURCE:]LIST:COPY Command ..... B-17
B.59	[SOURCE:]LIST:COUNT Command ..... B-17
B.60	[SOURCE:]LIST:COUNT? Query ..... B-18
B.61	[SOURCE:]LIST:COUNT:SKIP Command ..... B-18
B.62	[SOURCE:]LIST:COUNT:SKIP? Query ..... B-19
B.63	[SOURCE:]LIST:CURRENT Command ..... B-20
B.64	[SOURCE:]LIST:CURRENT? Query ..... B-20
B.65	[SOURCE:]LIST:CURRENT:APPLY Command ..... B-20
B.66	[SOURCE:]LIST:CURRENT:APPLY:SWEPT Command ..... B-21
B.67	[SOURCE:]LIST:CURRENT:APPLY:SWEPT? Query ..... B-21
B.68	[SOURCE:]LIST:CURRENT:POINTS? Query ..... B-21
B.69	[SOURCE:]LIST:DIRECTORY? Query ..... B-21
B.70	[SOURCE:]LIST:DIVIDER Command ..... B-21
B.71	[SOURCE:]LIST:DIVIDER? Query ..... B-22
B.72	[SOURCE:]LIST:DWELL Command ..... B-22
B.73	[SOURCE:]LIST:DWELL? Query ..... B-22
B.74	[SOURCE:]LIST:DWELL:POINTS? Query ..... B-22
B.75	[SOURCE:]LIST:ERASE Command ..... B-22
B.76	[SOURCE:]LIST:QUERY Command ..... B-22
B.77	[SOURCE:]LIST:QUERY? Query ..... B-22
B.78	[SOURCE:]LIST:RECALL Command ..... B-23
B.79	[SOURCE:]LIST:REPEAT Command ..... B-23
B.80	[SOURCE:]LIST:RESOLUTION? Query ..... B-23
B.81	[SOURCE:]LIST:SAMPLE:CURRENT Command ..... B-23
B.82	[SOURCE:]LIST:SAMPLE:VOLTAGE Command ..... B-24
B.83	[SOURCE:]LIST:SAMPLE? Query ..... B-29
B.84	[SOURCE:]LIST:SEGMENT Command ..... B-29
B.85	[SOURCE:]LIST:SEGMENT? Query ..... B-29
B.86	[SOURCE:]LIST:SET:SAMPLE Command ..... B-29
B.87	[SOURCE:]LIST:SET:SAMPLE? Query ..... B-29
B.88	[SOURCE:]LIST:SAVE Command ..... B-29
B.89	[SOURCE:]LIST:SET:TRIGGER Command ..... B-30
B.90	[SOURCE:]LIST:SET:TRIGGER? QUERY ..... B-30
B.91	[SOURCE:]LIST:SET:WAIT Command ..... B-30
B.92	[SOURCE:]LIST:SET:WAIT? QUERY ..... B-30
B.93	[SOURCE:]LIST:TRIGGER Command ..... B-30
B.94	[SOURCE:]LIST:VOLTAGE Command ..... B-31
B.95	[SOURCE:]LIST:VOLTAGE? Query ..... B-31
B.96	[SOURCE:]LIST:VOLTAGE:APPLY Command ..... B-31
B.97	[SOURCE:]LIST:VOLTAGE:APPLY:SWEPT Command ..... B-33
B.98	[SOURCE:]LIST:VOLTAGE:APPLY:SWEPT? Query ..... B-33
B.99	[SOURCE:]LIST:VOLTAGE:POINTS? Query ..... B-33
B.100	[SOURCE:]LIST:WAIT:HIGH Command ..... B-34
B.101	[SOURCE:]LIST:WAIT:LEDGE Command ..... B-34
B.102	[SOURCE:]LIST:WAIT:LOW Command ..... B-34
B.103	[SOURCE:]VOLTAGE[:LEVEL][:IMMEDIATE][:AMPLITUDE] Command ..... B-35

# TABLE OF CONTENTS

SECTION		PAGE
B.104	[SOURce:]VOLTage[:LEVel][:IMMediate][:AMPlitude]? Query .....	B-35
B.105	[SOURce:]VOLTage[:LEVel]:LIMit[:BOTH] Command .....	B-36
B.106	[SOURce:]VOLTage[:LEVel]:LIMit[:BOTH]? Query .....	B-36
B.107	[SOURce:]VOLTage[:LEVel]:LIMit:NeGative Command .....	B-36
B.108	[SOURce:]VOLTage[:LEVel]:LIMit:NeGative? Query .....	B-36
B.109	[SOURce:]VOLTage[:LEVel]:LIMit:POSitive Command .....	B-36
B.110	[SOURce:]VOLTage[:LEVel]:LIMit:POSitive? Query .....	B-36
B.111	[SOURce:]VOLTage:MODE Command .....	B-36
B.112	[SOURce:]VOLTage:MODE? Query .....	B-37
B.113	[SOURce:]VOLTage[:LEVel]:PROTect:BOTHS Command .....	B-37
B.114	[SOURce:]VOLTage[:LEVel]:PROTect[:BOTH]? Query .....	B-37
B.115	[SOURce:]VOLTage[:LEVel]:PROTect:MODE Command .....	B-38
B.116	[SOURce:]VOLTage[:LEVel]:PROTect:MODE? Query .....	B-38
B.117	[SOURce:]VOLTage[:LEVel]:PROTect:NeGative Command .....	B-38
B.118	[SOURce:]VOLTage[:LEVel]:PROTect:NeGative? Query .....	B-38
B.119	[SOURce:]VOLTage[:LEVel]:PROTect:POSitive Command .....	B-38
B.120	[SOURce:]VOLTage[:LEVel]:PROTect:POSitive? Query .....	B-38
B.121	[SOURce:]VOLTage[:LEVel]:PROTect:LIMit:BOTHS Command .....	B-38
B.122	[SOURce:]VOLTage[:LEVel]:PROTect:LIMit[:BOTH]? Query .....	B-39
B.123	[SOURce:]VOLTage[:LEVel]:PROTect:LIMit:NeGative Command .....	B-39
B.124	[SOURce:]VOLTage[:LEVel]:PROTect:LIMit:NeGative? Query .....	B-39
B.125	[SOURce:]VOLTage[:LEVel]:PROTect:LIMit:POSitive Command .....	B-39
B.126	[SOURce:]VOLTage[:LEVel]:PROTect:LIMit:POSitive? Query .....	B-39
B.127	[SOURce:]VOLTage[:LEVel]:TRIGgered[:AMPlitude] Command .....	B-39
B.128	[SOURce:]VOLTage[:LEVel]:TRIGgered[:AMPlitude]? Query .....	B-39
B.129	STATus:OPERation:CONDition? Query .....	B-40
B.130	STATus:OPERation:ENABle Command .....	B-40
B.131	STATus:OPERation:ENABle? Query .....	B-40
B.132	STATus:OPERation[:EVENTi] Query .....	B-40
B.133	STATus:PRESet Command .....	B-40
B.134	STATus:QUESTionable[:EVENTi]? Query .....	B-41
B.135	STATus:QUESTionable:CONDition? Query .....	B-41
B.136	STATus:QUESTionable:ENABle Command .....	B-41
B.137	STATus:QUESTionable:ENABle? Query .....	B-42
B.138	SYSTem:BEEP Command .....	B-42
B.139	SYSTem:COMMunication:GPIB:ADDRes Command .....	B-43
B.140	SYSTem:COMMunication:GPIB:ADDRes? Query .....	B-43
B.141	SYSTem:COMMunication:LAN:AUTO Command .....	B-43
B.142	SYSTem:COMMunication:LAN:AUTO? Query .....	B-43
B.143	SYSTem:COMMunication:LAN:DHCP Command .....	B-43
B.144	SYSTem:COMMunication:LAN:DHCP? Query .....	B-43
B.145	SYSTem:COMMunication:LAN:IP Command .....	B-43
B.146	SYSTem:COMMunication:LAN:IP? Query .....	B-43
B.147	SYSTem:COMMunication:LAN:MAC? Query .....	B-44
B.148	SYSTem:COMMunication:LAN:MASK Command .....	B-44
B.149	SYSTem:COMMunication:LAN:MASK? Query .....	B-44
B.150	SYSTem:COMMunication:LAN:LRST Command .....	B-44
B.151	SYSTem:COMMunication:SERial:BAUD Command .....	B-44
B.152	SYSTem:COMMunication:SERial:BAUD? Query .....	B-44
B.153	SYSTem:COMMunication:SERial:ECHO Command .....	B-44
B.154	SYSTem:COMMunication:SERial:ECHO? Query .....	B-45
B.155	SYSTem:COMMunication:SERial:PACe Command .....	B-45
B.156	SYSTem:COMMunication:SERial:PACe? Query .....	B-45
B.157	SYSTem:COMMunication:SERial:PRoMpt Command .....	B-45
B.158	SYSTem:COMMunication:SERial:PRoMpt? Query .....	B-45
B.159	SYSTem:ERRor? Query .....	B-45
B.160	SYSTem:ERRor:CODE? Query .....	B-45

# TABLE OF CONTENTS

SECTION		PAGE
B.161	SYSTem:ERRor:CODE:ALL? Query .....	B-46
B.162	SYSTem:KEYBoard Command .....	B-46
B.163	SYSTem:KEYBoard? Query .....	B-46
B.164	SYSTem:MDNS? Query .....	B-46
B.165	SYSTem:MDNS:INDex Command .....	B-46
B.166	SYSTem:MDNS:IND? Query .....	B-46
B.167	SYSTem:MDNS:NAME Command .....	B-46
B.168	SYSTem:MDNS:NAME? Query .....	B-46
B.169	SYSTem:MODE Command .....	B-47
B.170	SYSTem:MODE? Query .....	B-47
B.171	SYSTem:PASSword:CENable Command .....	B-47
B.172	SYSTem:PASSword:CDISable Command .....	B-47
B.173	SYSTem:PASSword:NEW Command .....	B-47
B.174	SYSTem:PASSword:STATe? Query .....	B-47
B.175	SYSTem:REMOte Command .....	B-47
B.176	SYSTem:REMOte? Query .....	B-47
B.177	SYSTem:SECurity:IMMediate Command .....	B-48
B.178	SYSTem:SET Command .....	B-48
B.179	SYSTem:SET? Query .....	B-48
B.180	SYSTem:VERSion? Query .....	B-48
B.181	TRIGger:SOURce Command .....	B-49
B.182	TRIGger:SOURce? Query .....	B-49



# LIST OF FIGURES

FIGURE	TITLE	PAGE
1-1	High Power BOP Series Power Supply .....	xii
1-2	2000W BOP Power Supply, Outline Drawing .....	1-15
1-3	BOP Output Characteristics .....	1-20
2-1	BOP Series Rear Panel (Control Section Cover Removed) .....	2-2
2-2	Packing/Unpacking .....	2-7
2-3	Earth Ground Connection Recommendations .....	2-11
2-4	Load Connections, Local Sensing .....	2-13
2-5	Load Connections, Remote Sensing .....	2-13
2-6	Fail Safe Feature, Simplified Schematic Diagram.....	2-14
2-7	PS Find Screen.....	2-16
2-8	Discovery using Safari Browser with Bonjour Installed.....	2-16
2-9	Typical screen Using LXI Discovery Tool.....	2-17
2-10	Web Interface Home Page (Unit Description) .....	2-18
2-11	Web Interface Configure LAN Page.....	2-19
3-1	BOP Series Front Panel.....	3-2
3-2	Front Panel Keypad .....	3-4
3-3	Start-up Screen.....	3-5
3-4	Power-up Screen Showing Graphic Meters.....	3-6
3-5	Power-up Screen Showing Time Line Graph.....	3-6
3-6	Password Protection Menu, Factory Defaults .....	3-12
3-7	Display Settings Menu .....	3-12
3-8	General Setup Menu .....	3-18
3-9	Max/Min Settings Menu .....	3-21
3-10	Saved Setups Menu.....	3-32
3-11	Saved Waveforms Menu.....	3-34
3-12	Edit Waveform Menu .....	3-36
3-13	New Waveform Menu .....	3-37
3-14	Sample Waveform .....	3-42
3-15	Remote Shutdown Using External Power.....	3-47
3-16	Remote Shutdown Using Internal Power .....	3-48
3-17	Remote Standby .....	3-48
3-18	Programming Example to Verify Previous Command has Completed.....	3-57
3-19	RS 232 Implementation .....	3-67
3-20	Web Interface Home Page (Unit Description) .....	3-72
3-21	Web Interface Configure LAN Page.....	3-73
3-22	Web Interface Operate Instrument Page .....	3-74
3-23	Reset Dialog Box .....	3-75
3-24	Waveform Dialog Box .....	3-76
3-25	Tree Diagram of SCPI Commands Used with BOP Power Supply.....	3-79
3-26	Message Structure.....	3-83
3-27	Status Reporting Structure.....	3-89
3-28	Typical Example Of BOP Power Supply Program Using SCPI Commands .....	3-91
4-1	Calibration Setup for Voltage Mode .....	4-5
4-2	Calibration Setup for Current Mode .....	4-8
4-3	Main Calibration Screen.....	4-10
A-1	GPIB Commands .....	A-3
B-1	Programming the Output.....	B-4
B-2	Using MEMory LOCation Commands and Queries .....	B-8
B-3	Using List Commands to measure sample at End of Pulse .....	B-9
B-4	Using List Commands to measure sample at Start of Pulse.....	B-10
B-5	Setting Limits .....	B-13
B-6	Using LIST Commands and Queries .....	B-17
B-7	Creating and Executing a complex Waveform Using LIST Commands.....	B-19
B-8	Using List Commands to measure sample at End of Pulse .....	B-25
B-9	Using List Commands to measure sample at Start of Pulse.....	B-26
B-10	Using List:WAIT Commands to Control Generation of a Waveform Measured	

# LIST OF FIGURES

FIGURE	TITLE	PAGE
	by Multiple External Devices using a Single External Pulse.....	B-27
B-11	Using List:WAIT Commands to allow an external device time to function while imposing a maximum wait time.....	B-28
B-12	Using ZDEC and ZINC WITH LIST:VOLT:APPL command.....	B-32
B-13	Square wave Using LIST:VOLT:APPL ZINC and LIST:VOLT:APPL ZDEC WITH Eleven Steps Each (Zero Plus 10 Non-Zero Values) .....	B-33
B-14	Using List:WAIT Commands to Control Generation of a Waveform Measured by Multiple External Devices using the Low-Going leading Edge of an External Pulse .....	B-35
B-15	Using PROT:LIM:POS and PROT:LIM:POS Commands to Set Asymmetrical Limits .....	B-37
B-16	Using Status Commands and Queries .....	B-42
B-17	Setting the Unit to Remote Mode via Serial (RS 232) Port .....	B-48
B-18	Using System Commands and Queries .....	B-49

# LIST OF TABLES

TABLE	TITLE	PAGE
1-1	BOP 2KW-MG/ME Model Parameters .....	1-2
1-2	BOP General Specifications .....	1-3
1-3	Equipment Supplied .....	1-17
1-4	Accessories .....	1-18
1-5	Safety Symbols .....	1-19
2-1	Rear Panel Connector/Terminal Block Functions .....	2-1
2-2	IEEE 488 Port Input/Output Pin Assignments .....	2-3
2-3	Trigger Port Pin Assignments .....	2-4
2-4	RS232C PORT Input/Output Pin Assignments .....	2-4
2-5	Analog I/O Port Input/Output Pin Assignments .....	2-5
2-6	External Protection Connector Input/Output Pin Assignments .....	2-6
3-1	Front Panel Controls and Indicators .....	3-2
3-2	Special Key Functions .....	3-4
3-3	Display Settings (Operator Convenience) Menu .....	3-14
3-4	Voltage and Current Parameter Definitions .....	3-16
3-5	Max/Min Settings Menu .....	3-19
3-6	Power Supply Behavior when Output is set to OFF .....	3-23
3-7	Power Up Settings menu .....	3-28
3-8	Examples Showing How Power-up Settings Function .....	3-29
3-9	Save/recall menu .....	3-31
3-10	Sine, Triangle and Ramp Waveform Frequency vs. Points .....	3-35
3-11	Square Waveform Frequency vs. Points .....	3-35
3-12	Waveform Segment Details Menu .....	3-38
3-13	New Waveform Settings Menu .....	3-39
3-14	Revisions/test Menu .....	3-44
3-15	Error Message Explanations .....	3-46
3-16	Analog Remote Setup Menu .....	3-49
3-17	Interface Settings Menu .....	3-58
3-18	LAN Interface Settings Menu .....	3-60
3-19	IEEE 488 (GPIB) Bus Interface Functions .....	3-63
3-20	IEEE 488 (GPIB) Bus Command Mode Messages .....	3-64
3-21	IEEE 488 (GPIB) Bus Data Mode Messages .....	3-64
3-22	Rules Governing Shortform Keywords .....	3-83
4-1	Calibration Summary .....	4-1
4-2	Suggested Sense Resistors .....	4-3
4-3	Voltage Calibration Measurements and Tolerances .....	4-3
4-4	Current Calibration Measurements and Tolerances .....	4-4
4-5	Calibration Storage .....	4-15
A-1	IEEE 488.2 Command/query Index .....	A-1
A-2	Standard Event Status Enable Register and Standard Event Status Register Bits .....	A-1
A-3	Service Request Enable and Status Byte Register Bits .....	A-5
A-4	Built-in test Error Codes .....	A-6
B-1	SCPI Subsystem Command/query Index .....	B-1
B-2	MEAS? Query Status Byte Register Bits .....	B-5
B-3	List Data Table .....	B-20
B-4	Operation Condition Register, Operation Enable Register, and Operation Event Register Bits .....	B-40
B-5	Questionable Event Register, Questionable Condition Register and Questionable Condition Enable Register Bits .....	B-41
B-6	Error Messages .....	B-49

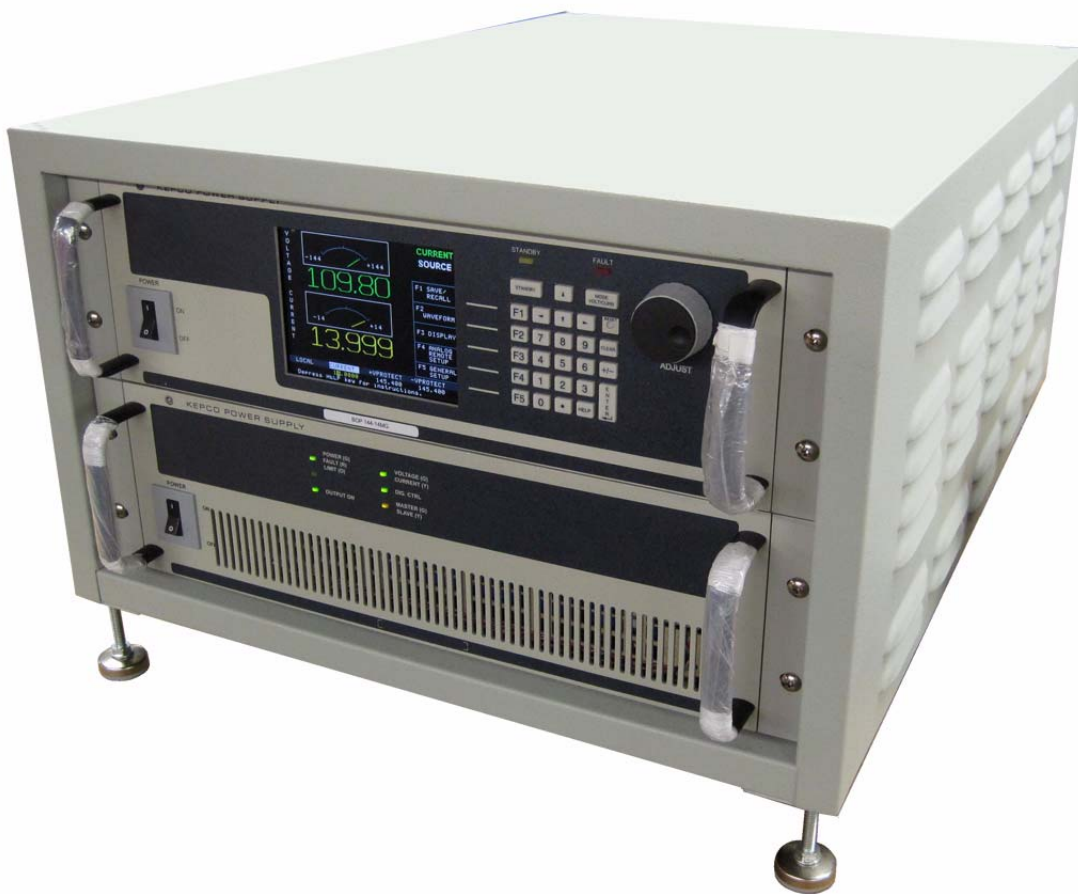

**FIGURE 1-1. HIGH POWER BOP SERIES POWER SUPPLY**

## SECTION 1 - INTRODUCTION

### 1.1 SCOPE OF MANUAL

This manual contains instructions for the installation, operation and servicing of the BOP series of 2000 Watt 4-quadrant bipolar, programmable, voltage and current stabilized d-c power supplies manufactured by Kepco, Inc., Flushing, New York, U.S.A.

This manual applies to both MG and MGL models with a GPIB digital interface and ME and MEL models with a LAN digital interface. BOP 2KW models with MG and ME suffixes are identical except that the MG units have a factory-installed GPIB interface and in the ME units the GPIB interface is replaced with a LAN interface. BOP-MG/ME models with an L suffix have been optimized for better performance when driving inductive loads such as large magnets or motors.

NOTE: This manual does not apply to units with a Firmware Revision less than 7.0.

### 1.2 GENERAL DESCRIPTION

The BOP Series (Figure 1-1), hereafter referred to as BOP, are true 4-quadrant programmable voltage and current power supplies, meaning they are capable of both sourcing and sinking power. These bipolar power supplies pass smoothly through zero without switching to provide true  $\pm$  voltage and  $\pm$  current. These BOP power supplies use switch mode technology for low dissipation. A bi-directional, isolating, a-c input power factor correcting (PFC) circuit recuperates energy sunked from an active load and sends it back into the line to maintain low dissipation.

These BOP Models are each comprised of a control section (upper) and power boost section (lower) which combine to achieve output power up to 2KW. The two sections are housed in an integral cabinet equipped with four levelling feet as well as casters for ease of moving the unit. Four threaded holes at the top of the cabinet accommodate eyebolts used to lift the unit.

The BOP operates in either VOLTAGE mode or CURRENT mode. When in Voltage mode, the power supply will (within the configured and rated limits) provide the programmed output voltage. Current is determined by the load, and cannot exceed the Current Protect limits. When in Current mode, the power supply will (within the configured and rated limits) provide the programmed output current. Voltage is determined by the load, and cannot exceed the Voltage Protect limits. Figure 1-3 defines the operating limits in each mode.

These BOP power supplies are controlled digitally from a menu-driven front-panel keypad or one of the standard remote digital interfaces (GPIB or RS 232 for MG models, or LAN or RS 232 for ME models) to set voltage and current and the four protection limits (+voltage, -voltage, +current and -current.) A front panel rotary adjuster allows real-time adjustment of the output. A large color LCD displays the settings, mode and the actual output voltage and current. Additionally, these BOP models can be remotely controlled by an analog  $\pm 10V$  input for the main channel (voltage or current), and a +1 to +10V input for the limit channels.

BOP models are suitable for driving inductive loads such as large magnets or motors, and for exercising batteries. They are also suitable for characterizing solar cell arrays, and powering many electrochemical reactions.

### 1.2.1 LXI COMPATIBILITY (ME MODELS)

BOP with the ME suffix are designed to meet the LXI Version 1.4 standard, providing the following standardized web interface capabilities for the user:

Discovery:

- MDNS (Bonjour - like the printer discovery)
- VXI-11 (National Instruments Ni Max, Agilent Io controller)

IP address support:

- DHCP
- AUTOIP
- Static IP (using Web Page)

Connections:

- SOCKET @ port 5025
- TELNET @ port 5024

Connection throughput:

- 25 milliseconds

NOTE: VXI-11 socket connection is provided for discovery. It only supports the \*idn? query in operation. Consult factory if this slow connection is required.

### 1.3 SPECIFICATIONS

Table 1-1 below indicates parameters that vary for different 2,000 Watt BOP models; Table 1-2 lists general specifications that apply to all 2,000 Watt BOP models.

**TABLE 1-1. BOP 2KW-MG/ME MODEL PARAMETERS**

Model <sup>(1)</sup>	d-c Output Range		Closed Loop Gain	
	Voltage <sup>(2)</sup> (V d-c)	Current (A d-c)	Voltage Channel G <sub>V</sub> (V/V)	Current Channel G <sub>I</sub> (A/V)
2000 WATT MODELS				
BOP 6-250MG/ME <sup>(3)</sup>	0 to ±6	0 to ±250	0.6	25.0
BOP 10-200MG/ME/MGL/MEL	0 to ±10	0 to ±200	1.0	20.0
BOP 12-125MG/ME	0 to ±12	0 to ±125	1.2	12.5
BOP 20-100MG/ME/MGL/MEL	0 to ±20	0 to ±100	2.0	10.0
BOP 25-80MG/ME	0 to ±25	0 to ±80	2.5	8.0
BOP 36-56MG/ME/MGL/MEL	0 to ±36	0 to ±56	3.6	5.6
BOP 40-50MG/ME/MGL/MEL	0 to ±40	0 to ±50	4.0	5.0
BOP 50-40MG/ME/MGL/MEL	0 to ±50	0 to ±40	5.0	4.0
BOP 72-28MG/ME/MGL/MEL	0 to ±72	0 to ±28	7.2	2.8
BOP 100-20MG/ME	0 to ±100	0 to ±20	10.0	2.0
BOP 144-14MG/ME	0 to ±144	0 to ±14	14.4	1.4
BOP 200-10MG/ME	0 to ±200	0 to ±10	20.0	1.0

(1) Models with MG suffix include GPIB and RS 232 digital interfaces. Models with ME suffix include LAN and RS 232 digital interfaces.  
(2) When connecting active loads, the steady-state voltage of the active load must not exceed the maximum voltage rating of the BOP. Otherwise the overvoltage protection will shut down the power supply.  
(3) This model can handle 1.5kW maximum.

**TABLE 1-2. BOP GENERAL SPECIFICATIONS**

SPECIFICATION		RATING/DESCRIPTION	CONDITION
<b>INPUT CHARACTERISTICS</b>			
a-c voltage	nominal	200/220/230/240Va-c <sup>(1)</sup> (200-240 Va-c)	No setting required. Single phase or between 2 phases of a 3-phase system within 200-240Va-c.
	range	176 - 264 Va-c	Continuous; Input voltage outside range causes protection fault.
Frequency	nominal	50/60 Hz	
	range	47 - 63 Hz	
Current	176 Va-c	9.5A (7.5A <sup>(2)</sup> )	maximum
	264 Va-c	6.4A (4.4A <sup>(2)</sup> )	maximum
Power factor	Source	0.99 minimum	nominal output power
	Sink	0.97 minimum	
Efficiency		65% (56% <sup>(2)</sup> )	minimum when sourcing
Switching frequency, front end module		70 KHz ±5% (50KHz ±5% <sup>(2)</sup> )	Active PFC Input for both Source and Recuperation (Sink)
EMC Compliance		EN61326-1 (1997)	Class A equipment
EMC immunity to:	ESD	EN61000-4-2	Electrostatic discharge
	Radiated RF	EN61000-4-3	
	EFT	EN61000-4-4	Electrical fast transient/burst
	Surges	EN61000-4-5	
	Conducted RF	EN61000-4-6	
EMC emissions	Conducted	EN61000-3-2	harmonics
		EN61000-3-3	fluctuation & flicker
	Conducted	EN55011/CISPR11	0.15 to 30 MHz
	Radiated	EN55011/CISPR11	30 to 1000 MHz
Leakage current		3.5 mA	230V a-c, 47-63 Hz
Insulation coordination	Input	Installation Category II	For TN or TT power system
		Overvoltage Category II	
	Output	Installation Category II	Maximum 300V (500V for BOP 10-100MG/ME) common mode voltage between output terminals and chassis ground.
		Overvoltage Category II	
Pollution degree		2	
<b>OUTPUT CHARACTERISTICS <sup>(3)</sup></b>			
Type of stabilizer		Voltage-current, 4-quadrant	Switch mode
Switching frequency, output module		100KHz ±5%	Output Stage
Source adjustment range	voltage	-100% to +100% of rating	0 to 50 deg C
	current	-100% to +100% of rating	
Sink adjustment range	voltage	-100% to +100% of rating	0 to 50°C, recuperated energy is sent back into line for general reuse
	current	-100% to +100% of rating	

(1) All specifications listed in this table are for 230V a-c input voltage.

(2) BOP 6-125MG/ME and BOP 10-75MG/ME only.

(3) Output characteristics are for a single standalone unit. Output characteristics of identical multiple unit parallel/series configurations are described in the Technical Manual associated with the applicable Cable Kit (see Table 1-4).

**TABLE 1-2. BOP GENERAL SPECIFICATIONS (Continued)**

SPECIFICATION		RATING/DESCRIPTION	CONDITION
<b>OUTPUT CHARACTERISTICS (Continued)</b>			
Digital Programming resolution / accuracy	Voltage	14 bits / 0.03%	3% accuracy for Ext Ref Level (see PAR. 3.4.4.2). Unit gain adjustable between 0 and $E_{ONOM}$ (voltage) or $I_{ONOM}$ (current).
	Current	14 bits / 0.1%	
	Voltage Limit	12 bits / 0.3%	
	Current Limit	12 bits / 0.5%	
Digital Readback resolution / accuracy	Voltage	16 bits / 0.05%	main or limit channel
	Current	16 bits / 0.1%	main or limit channel
	Sustain Output update rate	90 updates/Sec	voltage or current via GPIB interface
		120 updates/Sec	voltage or current via RS 232 interface @ 38.4K baud
Analog Programming accuracy	Voltage	0.1% of rating	<ul style="list-style-type: none"> <li>Voltage and Current limit in Voltage Mode and Current and Voltage Limit in Current Mode.</li> <li>The programming signal is 0V to <math>\pm 10V</math> for 0 to <math>\pm E_{ONOM}</math> (Voltage mode) or for 0 to <math>\pm I_{ONOM}</math> (Current mode).</li> <li>The programming signal is +1V to +10V for 10% to 100% of all four limits (<math>\pm</math>voltage, <math>\pm</math>current)</li> <li>Input impedance is 20KOhms for the main channel (voltage or current)</li> <li>When the limit channels are not used, the limits are clamped to 1% above the nominal values.</li> <li>The limit source must be able to sink a maximum 0.15mA @ +1V programming signal</li> <li>Gain adjustable range: 10% (recommended) to 100% of nominal gain.</li> </ul>
	Current	0.1% of rating	
	Voltage Limit	0.3% of rating	
	Current Limit	0.5% of rating	
	Voltage, variable gain	3% of rating	
	Current, variable gain	4% of rating	
Analog Readback accuracy	Voltage	-	Available on request: 0 to $\pm 10V$ for 0 to $\pm$ nominal output voltage.
	Current	0.1% of rating	0 to $\pm 10V$ for 0 to $\pm$ nominal output voltage; accuracy is for d-c or very low frequency a-c signals.
Digital Readback Characteristics	measurement rate	GPIB: 11mS	
		LAN: 25mS	
		38.4K baud Serial: 28mS	
		19.2K baud Serial: 32mS 9600 baud Serial: 38mS	
	measurement array	64 samples	voltage and current
	rejection of line-related ripple/noise	50, 60, 125Hz	Digital readback (see PAR. B.10).
	Maximum time between setpoint change and measurement response	<p style="text-align: center;"><u>Average</u>   <u>Max.</u></p> GPIB: 45mS   55mS LAN: 55mS   60mS 38.4K baud Serial: 55mS   60mS 19.2K baud Serial: 60mS   65mS 9600 baud Serial: 75mS   80mS	Standalone only. See PAR. 3.5.1.2 for details



**TABLE 1-2. BOP GENERAL SPECIFICATIONS (Continued)**

SPECIFICATION		RATING/DESCRIPTION	CONDITION
<b>OUTPUT CHARACTERISTICS (Continued)</b>			
Voltage stabilization in voltage mode	source effect	0.05% of rating	min-max input voltage, 230V a-c reference
	load effect	0.1% of rating	0-100% load current
	time effect (drift)	0.02% of rating	0.5 through 8 hours
	temperature effect	0.02%/deg C of rating	0 to 50 deg C
	ripple and noise	(2% E <sub>Omax</sub> ) p-p/(0.2% E <sub>Omax</sub> ) rms	Full scale, nominal resistive load; includes switching noise
Current stabilization in current mode	source effect	0.05% of rating	min-max input voltage, 230V a-c reference
	load effect	0.2% of rating	0-100% load voltage
	time effect (drift)	0.02% of rating	0.5 through 8 hours
	temperature effect	0.02%/deg C of rating	0 to 50 deg C
	ripple and noise	2% I <sub>Omax</sub> p-p / (0.2% I <sub>Omax</sub> ) rms	Full scale, load is shunt only; includes switching noise
Output isolation voltage	d-c or p-p	300V (500V for BOP 10-100MG/ME)	Output to chassis ground
	d-c leakage current	0.1mA @ 300V (0.1mA @ 500V for BOP 10-100MG/ME)	GND-NET to GND link not installed. <sup>(4)</sup>
Error sensing		0.25V or 1% of voltage rating per wire (whichever is less)	Above rated output <sup>(5)</sup>
Transient recovery in voltage mode	maximum excursion	5% of nominal output	nominal voltage, 50% load step
	Recovery time	200 μS	Return within 0.1% of set voltage
Power-up timing (parallel, series and series-parallel systems)		15 Sec max.	For system to be able to respond to analog or digital control.
Output Protection limiting	Analog	Voltage and current limited in four quadrants, adjustable between 10% and 101% of E <sub>ONOM</sub> or I <sub>ONOM</sub> . The analog limits are converted to digital limits at 100ms update rate.	
	Digital	Voltage and current limited in four quadrants, adjustable between ±Internal minimum E <sub>OMIN</sub> or I <sub>OMIN</sub> (box) (see Figure 1-3) and ±1.01 E <sub>ONOM</sub> or I <sub>ONOM</sub> .	

(4) With GND-NET to GND link installed: 0.55mA at 300V (0.91mA at 500V for BOP 10-100MG/ME).

(5) Remote error sensing applies to the main voltage channel. Feedback for the ±voltage limit channels is supplied locally from the power terminals. Consult factory for a remote sensing solution applicable to the voltage limit channels.

**TABLE 1-2. BOP GENERAL SPECIFICATIONS (Continued)**

SPECIFICATION		RATING/DESCRIPTION	CONDITION
<b>OUTPUT CHARACTERISTICS (Continued)</b>			
Output Stage Protection		Output overvoltage/overcurrent Heatsink overtemperature, switchers overcurrent	Triggers latched shutdown protection of the output module and PFC stage. Recover by cycling power off, then on or by pressing <b>RESET</b> at the front panel.
Input Stage Protection (PFC)		Internal overvoltage, undervoltage, overcurrent, heat sink overtemperature, fan inoperative	
		Input circuit breaker overcurrent	Trips circuit breaker to shut off unit
Small signal Bandwidth	voltage channel	2 KHz minimum	Into nominal resistive load 10% of rating
	current channel	800 Hz minimum (BOP 6-125MG: 600 Hz minimum)	Into short circuit, 10% of rating
Rise/Fall time	voltage channel	300/300 $\mu$ S	Into nominal resistive load, measured from 10 to 90%, from 0 to $\pm$ 100% of rating
	current channel	500/500 $\mu$ S	Into short circuit, measured from 10 to 90%, from 0 to $\pm$ 100% of rating
<b>PROGRAMMING/DISPLAY CHARACTERISTICS</b>			
Analog I/O Port (See Table 2-5)	Main channel (voltage or current)	-10V to +10V	Full range output, 20K Ohm input impedance (see PAR. 3.4)
	Protection Limit channels: ( $\pm$ Voltage, $\pm$ Current)	+0.05V to +10V	0.5% to 100% of Nominal Range. Input voltage clamped to 12V through 1K ohms. Maximum of 0.15mA input current at 1V input voltage.
	Mode Control	Voltage: open circuit or TTL logic 1 Current: short circuit or TTL logic 0	Available only when digitally activated through Power-up setting.
	Output Current Analog Readback	0 to $\pm$ 10 Volts corresponds to zero to $\pm$ Full Scale nominal output current	Output impedance of this signal is 2K Ohms.
External Protection Port (see Table 2-6)	External Shutdown	Isolated input for shutdown of the BOP (latched status)	Pulse width: 100 $\mu$ S min. Action delay: 100 $\mu$ S max Restore operation by cycling input power or pressing <b>RESET</b> key.
	External Shutdown Flag	Isolated output indicating shutdown status)	Action delay: 100 $\mu$ S max
	External On-Off Flag or External Trigger	Flag: Isolated output indicating output on (enabled, STANDBY off) or off (disabled, STANDBY on) status)  Trigger: Isolated trigger output for external devices.	Flag: LIST:SET:TRIG enables trigger function. Flag action delay: 200 mS max  Trigger: LIST:CLE disables trigger and restores flag. Trigger output pulse duration: settable between 0.25 to 34mS Trigger output action delay: 100 $\mu$ S max. Trigger output active level: settable to either "0" or "1."

**TABLE 1-2. BOP GENERAL SPECIFICATIONS (Continued)**

SPECIFICATION	RATING/DESCRIPTION		CONDITION
<b>PROGRAMMING/DISPLAY CHARACTERISTICS (Continued)</b>			
Trigger Port (See Table 2-3) Shutdown (pin 2):	Operation of pin 2 is controlled by OUP:CONT command (see Par. B.23). Settings are LPLS (default), HON, LON, HOFF, LOFF, OFF. Either OFF, LPLS, LOFF or HOFF is required if using OUP ON and OUP OFF commands to control the output. Setting output to off stops a running list.		
LPLS (default)	External Trigger Shutdown (Isolated input. Front panel display shows Low-Pulse. Logic 0 or short-circuit causes the output to go to STANDBY (off, disabled) (latched status)	Pulse width: 100 $\mu$ S min. Action delay: 200 mS max Restore operation by pressing <b>STANDBY</b> key. or sending OUP ON command via remote interface.	
HON	Front panel display shows HighsOn. Isolated Input for controlling output status, on or off. High or open (not connected), output is on (enabled). When 0 volts or short circuit applied to the pin, output is off (disabled)	Pulse width: 6 mS min for any guaranteed unit response. Action delay: 200 mS max	
LON	Front panel display shows LowIsOn. Isolated Input for controlling output status, on or off. Logic 0 = output is on (enabled); Logic 1 or open (not connected) = output is off (disabled).	Pulse width: 6 mS min for any guaranteed unit response. Action delay: 200 mS max	
LOFF	Front panel display shows LowIsOff. Isolated Input. When disconnected or open, STANDBY and OUP ON commands will set output on. When low or shorted, output is always off.	Action delay: 200 mS max	
HOFF	Front panel display shows HighIsOff. Isolated Input. When disconnected or open, output is always off. When low or shorted, STANDBY key and OUP ON commands will set output on.	Action delay: 200 mS max	
OFF	Trigger port disabled. Inputs applied to pin 2 have no effect.		
External Trigger Input (pin 4)	Isolated input for trigger events	Pulse width: 100 $\mu$ S min. Action delay: 500 $\mu$ S max	
<b>FUNCTION GENERATOR CHARACTERISTICS (See PAR. 3.3.10)</b>			
Digital control	local	Panel-mounted keypad	Direct Entry
	remote	IEEE 488-2 (GPIB)	SCPI
	remote	RS 232	
	remote	RS 485 (BITBUS)	Used for series and parallel configurations.
Display	front panel	4.7 inch backlit 16-bit color LCD, displays all functions	
	remote (MG models)	All parameters read back on GPIB or RS 232 buses	
	remote (ME models)	All parameters read back on LAN or RS 232 ports	
Maximum number of waveforms		16	Local: Saved for power-up

**TABLE 1-2. BOP GENERAL SPECIFICATIONS (Continued)**

SPECIFICATION	RATING/DESCRIPTION	CONDITION
<b>FUNCTION GENERATOR CHARACTERISTICS (Continued)</b>		
Maximum number of segments or basic waveforms per waveform	Local: 10 Remote: 100	Or maximum number of points (whichever comes first) <ul style="list-style-type: none"> <li>The time interval for each segment depends on the type of waveform: period for ramp and square waveforms, period or fraction of period for sine and triangular waveforms and time interval for DC levels</li> <li>Segments that cause the waveform to exceed the maximum number of points are not executed. For local operation they are marked with a triple asterisk on the front panel. For remote operation an error message is generated.</li> </ul>
Types of Basic waveforms	Sine (Sinusoidal waveform) Triangle (Triangular waveform) Pos. Ramp (Ramp waveform) Neg. Ramp (Sawtooth waveform) Square (50% Duty Cycle Pulse) Level (DC waveform)	
Maximum number of points per basic waveform	Local: 3933	
Count (Number of repetitions)	Range: 1 to 255 For Count = 0 the waveform is executed indefinitely until stop command is sent	<ul style="list-style-type: none"> <li>Local: Factory default: when the count is complete or if execution is stopped using , the output of the unit is set to OFF (Standby indicator lit). Output must be enabled (press STANDBY) to execute the waveform again. (See Table 3-3, WAVEFORM STOP for additional settings.)</li> <li>Remote: When the count is complete or the waveform is stopped using the VOLT:MODE FIX command, the output remains at last output value.</li> </ul>
Waveform Name	10 characters maximum	Upper case only, no spaces
Waveform Parameters	Type: Voltage or Current  Positive Protection Limit: (Vd-c or Ad-c)  Negative Protection Limit: (Vd-c or Ad-c)  Count: number  Initial/Repeating	<ul style="list-style-type: none"> <li>Type of waveform, voltage or current, can be selected only for a new waveform and consequently applies to all waveform segments. Changing the type for an existing waveform is not possible, unless the waveform is erased first.</li> <li>The Protection values (positive/negative) and the count number apply to all waveform segments and can be edited at the beginning of a new waveform or later when modifying a waveform (see PAR. 3.3.10.8).</li> <li>All segments except the last may be set to run once (Initial) or per the Count setting (Repeating).</li> </ul>

**TABLE 1-2. BOP GENERAL SPECIFICATIONS (Continued)**

SPECIFICATION	RATING/DESCRIPTION	CONDITION
<b>FUNCTION GENERATOR CHARACTERISTICS (Continued)</b>		
Basic waveform parameters	<p><b>Sine:</b> Frequency (Hz), Amplitude (Vp-p or Ap-p), Offset (Vd-c or Ad-c), Start Phase (°), Stop Phase (°).</p> <p><b>Triangular:</b> Frequency (Hz), Amplitude (Vp-p or Ap-p), Offset (Vd-c or Ad-c), Start Phase (°), Stop Phase (°).</p> <p><b>Ramp (Pos. or Neg.):</b> Frequency (Hz), Amplitude (Vp-p or Ap-p), Offset (Vd-c or Ad-c).</p> <p><b>Slope:</b> Period (Sec), Starting Amplitude (V or A): Ending Amplitude (V or A)</p> <p><b>Square:</b> Frequency (Hz), Amplitude (Vp-p or Ap-p), Offset (Vd-c or Ad-c).</p> <p><b>Level:</b> Period (duration) (Sec), Amplitude (Vd-c or Ad-c).</p> <ul style="list-style-type: none"> <li>Local: the Start/Stop phases, available for sine and triangle only, can be set or edited by modifying the existing segment (see PAR. 3.3.10.8).</li> <li>Remote: the start/stop phases are global parameters, applicable to all sine/ triangular waveform segments.</li> <li>The Start/Stop points are independent and can have any value between 0° and 360°.</li> </ul> <p><b>ZDEC</b> Decrement to Zero, n (n = No. of steps). Each repeating segment that follows is successively decreased in amplitude by <math>A = A[1/(n-1)]</math>, starting from A down to 0, where A = amplitude specified in repeating segment.</p> <p><b>ZINC</b> Increment from Zero, n (n = No. of steps). Each repeating segment that follows is successively increased in amplitude by <math>A = A[1/(n-1)]</math>, starting from 0 up to A, where A = amplitude specified in repeating segment.</p>	
LIST command characteristics for "string" type waveform (Remote only)	<p>Maximum number of points</p> <ul style="list-style-type: none"> <li>For single (global) dwell time: 5900 (high resolution)</li> <li>For 100 or fewer different dwell times: 3933</li> <li>For 115 or more different dwell times: 2950</li> </ul> <p>Dwell time range: 93µS to 34mS.</p> <p>Dwell time resolution (increment): 0.751µS</p> <p>Skip feature (a number of steps can be skipped from the LIST at the first run using LIST:COUN:SKIP.)</p> <p>Able to synchronize a LIST command with multiple BOP's or other devices using Trigger Port (see Table 2-6 NOTE).</p> <p>Able to sample output voltage or current during LIST command execution (see Figures B-3 and B-4).</p> <p>Note: Dwell time list must match (balance) the amplitude list.</p>	

**TABLE 1-2. BOP GENERAL SPECIFICATIONS (Continued)**

SPECIFICATION	RATING/DESCRIPTION	CONDITION
<b>FUNCTION GENERATOR CHARACTERISTICS (Continued)</b>		
Waveform graphics displayed on LCD for both Local and Remote operation	<p>Local: The LCD represents the programming waveform graph of the main channel, voltage for voltage mode or current for current mode.</p> <ul style="list-style-type: none"> <li>There is no difference between programming and real output waveform, as long as programmed Limits are not exceeded and the load is resistive. The programming waveform representation does not taking into account the interaction between settings and load.</li> <li>The graph timing is automatically selected for the best waveform representation.</li> <li>Because the BOP unit is not an oscilloscope, the waveform representation is sometimes very sketchy, especially if there is a large difference between the timing of two adjacent segments or for a reduced number of repetitions of high frequency waveform. Also, synchronization is difficult for low frequency waveforms.</li> </ul> <p>Remote: When using LIST commands for waveform creation/ execution, the LCD displays the actual or real waveform graphs of the main and limit channel, voltage &amp; current protection limit for voltage mode and current &amp; voltage protection limit for current mode. Main and Limit graphs are not phase correlated.</p> <ul style="list-style-type: none"> <li>In order to get a meaningful representation, the graph timing must be chosen properly. It is recommended that the first value higher than total waveform time be chosen from the 12 time selections, spread from 0.04 Second to 75 Seconds.</li> </ul>	
Frequency:		Not applicable to Level
Range (Hz)	0.001 to 443 (0.001 to 0.76 if ZINC or ZDEC used)	Sine, Triangle
	0.02 to 532 (0.02 to 1.52 if ZINC or ZDEC used)	±Ramp
	0.02 to 990 (0.001 to 0.76 if ZINC or ZDEC used)	Square
Programming Resolution (Hz)	0.001 minimum	Sine, Triangle
	0.01 minimum	Ramp, Square
Accuracy	1.5% of Frequency	Sine, Triangle, Square, ±Ramp
Period (applicable to Level and Slope only)		
Level: Range (Seconds):	0.0001 TO 5.0000 (local front panel) 0.0030 TO 5.0000 if ZDEC/ZINC used	0.0005 to 5.0000 (remote interface)
Slope: Range (Seconds):	0.03 TO 4.0 (local front panel) 0.05 TO 4.0 if ZDEC/ZINC used	0.03 TO 4.0 (remote interface)
Resolution:	0.0001	
Accuracy:	1.5% of Time Duration	
Amplitude Range		
Main Channel	Voltage (Volts p-p)	0 to 2 x E <sub>ONOM</sub>
	Current (Amperes p-p)	0 to 2 x I <sub>ONOM</sub>
Protection Limit Channel	Current, bipolar (Amperes)	0 to I <sub>ONOM</sub>
	Voltage, bipolar (Volts)	0 to E <sub>ONOM</sub>
Offset	Voltage (Volts)	-E <sub>ONOM</sub> to +E <sub>ONOM</sub>
	Current (Amperes)	-I <sub>ONOM</sub> to +I <sub>ONOM</sub>

**TABLE 1-2. BOP GENERAL SPECIFICATIONS (Continued)**

SPECIFICATION		RATING/DESCRIPTION	CONDITION
<b>FUNCTION GENERATOR CHARACTERISTICS (Continued)</b>			
Amplitude Resolution (Programming)			
Main Channel and Offset	Voltage (millivolts a-c)	.35	Sine
	(millivolts d-c)	1	Triangle, Square, $\pm$ Ramp, Level
	Current (milliamperes a-c)	.35	Sine
	(milliamperes d-c)	1	Triangle, Square, $\pm$ Ramp, Level:
Protection Limit Channel .	Current, bipolar (Amperes)	0.1	
	Voltage, bipolar (Volts)	0.1	
Amplitude Accuracy			
Main Channel and Offset	Voltage	0.03% $E_{ONOM}$	
	Current	0.1% $I_{ONOM}$	
Protection Limit Channel.	Current	0.5% $I_{ONOM}$	
	Voltage	0.3% $E_{ONOM}$	
Distortion (THD-F, Total Harmonic Distortion relative to the fundamental component)		5% max.	Sine
		13% max.	Triangle
		70% max.	$\pm$ Ramp
		47% max.	Square
Start/Stop Angle (Phase) Range		0 to 360°	Sine, Triangle
	Programming Resolution	0.01°	
Accuracy	Start Angle	1°	
	Stop Angle	1° @ 0.01Hz, to 16° @ 443 Hz	Frequency dependent
<b>SAVE/RECALL CHARACTERISTICS</b> (See PAR. 3.3.9)			
Number of Locations		74	
Parameters Saved or Recalled			All parameters saved for power-up.
	Mode of operation	Voltage, Current or External	For External the operating mode is determined by signal at I/O Port; no signal selects voltage mode (see PAR. 3.4.3).
	Reference type	Internal, External or External Reference Level	Main channel
		Internal, External or Lesser Limit	Limit channel
	Main Amplitude (Internal)	0 to $E_{ONOM}$ or $I_{ONOM}$ (internal or external)	Main Channel: Voltage (Volts) for Voltage mode, Current (Amperes) for Current mode
	Protection Limit Amplitude (Internal)	$E_{OMIN}$ or $I_{OMIN}$ to 1.01 $E_{ONOM}$ or $I_{ONOM}$	Limit Channel, Positive and Negative Voltage (Volts) for Current mode, Current (Amperes) for Voltage mode
	Output status	ON or OFF	

**TABLE 1-2. BOP GENERAL SPECIFICATIONS (Continued)**

SPECIFICATION	RATING/DESCRIPTION	CONDITION
<b>MISCELLANEOUS FEATURES</b>		
Maximum/Minimum Settings		
Protection Limit Type	Bipolar (default) or Independent	
Main Channel	0 to $E_{ONOM}$ or $I_{ONOM}$ (default)	Software limit to setting of main channel Voltage (Volts) for Voltage mode, Current (Amperes) for Current mode
Protection Limit Channel (maximum value, Internal)	$E_{OMIN}$ or $I_{OMIN}$ to 1.01 $E_{ONOM}$ or $I_{ONOM}$ (internal)	Software limit to setting of protection limit channel. Voltage (Volts) for Current mode Current (Amperes) for Voltage mode
Load Type Settings	Active (default), Resistive, Battery, Custom	Consult factory for custom setting.
Self-test capabilities	Display, Keypad, Digital Interface, Serial Interface, Analog, Output	Serial Interface test requires Loop Back Test connector (p/o KIT 219-0436, see Table 1-4).
Interface Settings	Data Format	SCPI (default), CIL
	GPIO Address	0 to 30 (6 = default)
	Output Status @ Reset	ON or OFF (OFF = default)
	Serial Baud Rate	Off, 9600, 19200 (Off = default)
	Device Clear	SCPI (default) or MATE
	XON/XOFF	Enable (default) or Disable
	Prompt	Disable (default), Enable, Enable with Echo
Calibration	Assisted by front-panel prompts	
Power-up Settings	Mode	Voltage (default) or Current
	Main Channel Reference Type	Internal (default), External or External Reference Level (Gain Mode)
	Protection Limit Channel Reference type	Internal (default), External or Lesser Limit
	Protection Limit Levels (Internal)	$E_{OMIN}$ or $I_{OMIN}$ to 1.01 $E_{ONOM}$ or $I_{ONOM}$
	Output status	On (default) or Off
Password	Types	Main, Admin1, Admin2
	Protection Choices	Unprotected, Main, Admin1, Admin2
	Items Protected	Interface, max/min, Load type, Test, Calibration, Power-up, Keypad @ local, Keypad lockout at power-up, Save Display Chg (See Figure 3-6 for defaults)
		Multiple unit configurations are protected by Admin2 password.  Save Display Chg choice is Enable or Disable; when set to Disable, prevents changes made to the display settings from being saved for power up.



**TABLE 1-2. BOP GENERAL SPECIFICATIONS (Continued)**

SPECIFICATION		RATING/DESCRIPTION	CONDITION
<b>GENERAL (ENVIRONMENTAL) CHARACTERISTICS</b>			
Temperature	operating	0 to +50 deg C	Full rated load
	storage	-20 to +85 deg C	
Cooling		Two internal fans	exhaust to the rear
Humidity		0 to 95% RH	non-condensing
Shock		20g, 11mS ±50% half sine	non-operating
Vibration	5-10HZ:	10mm double amplitude	3 axes, non-operating
	10-55HZ:	2g	3 axes, non-operating
Altitude		sea level to 10,000 feet	
Safety Certification	a-c power	UL 3101-1 and EN 6101-1	Pending
<b>PHYSICAL CHARACTERISTICS</b>			
Dimensions	English	15.05' X 21.09" X 30.0"	H X W X D
	metric	387.4mm X 535.7.6mm X 762.05mm	H X W X D
Weight, 2000W models	English	250 lbs	
	metric	113.4 kg	
Connections	Source power	3-terminal terminal block	
	Load connections	Binding Posts (3)	OUT (red), COM (black), GND (green)
	Sensing Output Terminal Block	5-pin terminal block	Default: 2 links installed for local sensing
	Analog I/O control port	15-pin D female	See Figure 2-1, Table 2-5
	EXT PROT port	6-pin phone jack	See Table 2-6
	Primary digital port	24-pin GPIB connector	IEEE 488 port - See Table 2-2
	Secondary digital port	6-pin phone jack	RS 232 port - See Table 2-4
	External Trigger	4-pin stereo audio phone jack	See Table 2-3

## 1.4 LOCAL CONTROL

Either the front panel keypad or the adjust control can set and adjust output voltage and current under local control. The display provides a digital display of output voltage and current as well as a pictorial display of real-time analog voltage and current meters.

The keypad includes five function keys which provide access to the menu-driven functions of the unit. The menu screens provide access to save the unit's settings, recall previously saved settings, configure or execute a waveform, display references or configure the unit by setting GPIB address, Serial protocols, maximum acceptable voltage and current, etc. (see PAR. 3.3 for details on local control).

Context-sensitive help screens are available by pressing the HELP key. Actual output voltage and current displays are available while the help screens are displayed.

## 1.5 REMOTE CONTROL

The BOP Power Supply can be remotely controlled directly via either the IEEE 488.2 (GPIB) bus (MG models only, see PARs. 3.5 and 3.5.4), LAN Interface (ME models only, see PAR. 3.5.7) or RS232C (see PAR. 3.5.6) interface using SCPI commands (see and Appendix A and B). Most features available in local mode can also be accessed remotely via the digital interface. The unit can be controlled with a VISA (Virtual Instrumentation Software Architecture) driver to facilitate remote programming of the BOP Power Supply (see PAR. 3.5.5). The VISA driver is an interface written in standard C language which adds the proper SCPI syntax to commands sent to the BOP.

The BITBUS is used to allow communication between identical BOP units that are connected in series and/or parallel to expand the voltage or current range (see PAR. 2.7.6.2).

The BOP can also be controlled remotely using analog signals applied to the Analog I/O Port (see PAR. 3.4 for details.)

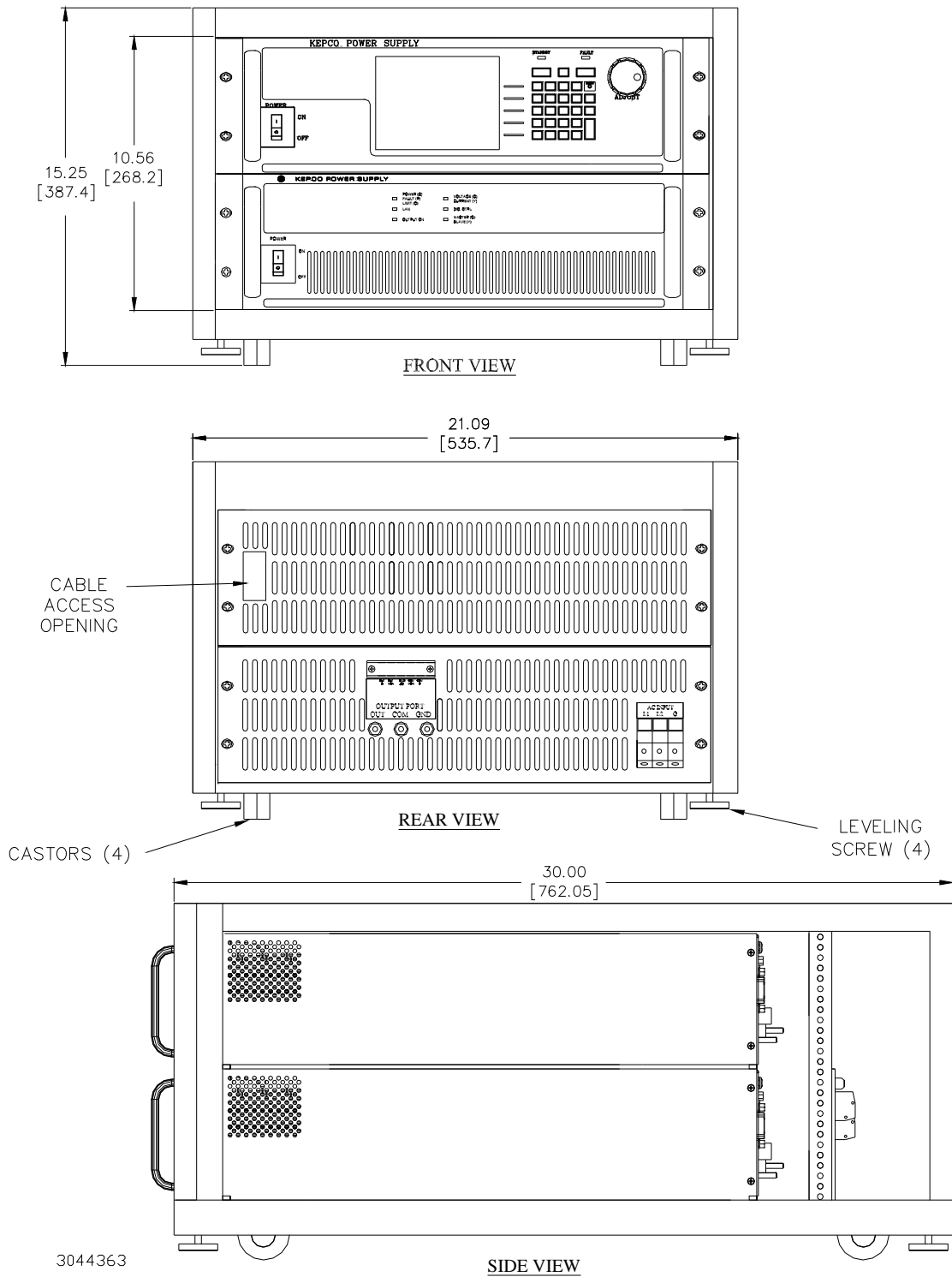

**FIGURE 1-2. 2000W BOP POWER SUPPLY, OUTLINE DRAWING**

## **1.6 FEATURES**

### **1.6.1 DIGITAL CALIBRATION**

The BOP Power Supply contains no internal adjustments. Calibration is done entirely via the keypad or remotely via the GPIB (for MG models), LAN (for ME models) or RS 232 interface using digital entries and a calibrated DVM, a precision d-c reference voltage source and precision shunt resistor. Calibration instructions appear on the front panel after a password is entered; previous calibration values are saved and can be restored using the remote interface if desired. The original factory calibration values can also be restored using the remote interface. (Refer to Section 4.)

### **1.6.2 VOLTAGE/CURRENT PROTECTION**

Positive and negative voltage and current protection values can be individually programmed. Refer to PAR. 3.3.3.

### **1.6.3 WAVEFORMS**

The BOP models have the capability to make the output follow complex waveforms. These may be generated either externally, using an analog reference voltage (see PAR. 1.6.6), or internally, using user-generated waveforms. The waveforms can be setup and recalled from both the front panel display and the computer interfaces.

Up to 16 user-generated waveforms can be stored for later use. The user selects the operating mode, positive and negative protection levels, and a count (the number of times the waveform is to be repeated). Each waveform consists of up to 10 segments; each segment is assigned one of six basic waveform types: square, sine, triangle, negative ramp, positive ramp and level. Depending on the waveform type, frequency, peak-to-peak amplitude, offset, and start and stop phase angle are then assigned by the user.

Segments at the beginning of the waveform can be programmed to be executed only once, or to be repeated as specified by the count. A graphic representation on the LCD shows the waveform as segments are added and is displayed prior to execution. This feature provides unique versatility for generating a waveform that meets user requirements. Refer to PAR. 3.3.10 for further details.

### **1.6.4 SAVING AND RECALLING SETTINGS**

The BOP offers 99 memory locations accessible from the front panel that can be used to store a set of operating parameters for later use. For each location, the user can store operating mode, output on/off, Main channel reference type and value, and protection reference type and value. The stored settings can then be recalled to quickly program the unit to the predetermined setting. Refer to PAR. 3.3.9 for further details.

### **1.6.5 EXTERNAL REFERENCE (ANALOG CONTROL)**

An external reference, provided through the rear analog port connector (see Table 2-5), can be used to control the output of the BOP. The external reference may be applied directly or can be attenuated by the digital controls (see PAR. 3.4.4.2). The BOP will limit its output based on the user configurable limits so that, in the event of a failure in the external reference, the devices connected to the output are protected. Refer to PAR. 3.4 for further details on using external signals to control the output.

### 1.6.6 EXTERNAL LIMITS

When the unit is controlled by an external reference, the protection limits can also be controlled by analog signals that are digitally calibrated. The BOP samples the limit channel inputs and applies the proper limit levels at a 5 mS rate with the positive and negative limits being sampled alternately. The external limit inputs are hardware-protected against overvoltage. Refer to PAR. 3.4.5

### 1.6.7 USER-DEFINED VOLTAGE/CURRENT MAXIMUM VALUES (SOFTWARE LIMITS)

The BOP output can be programmed not to exceed user-defined values. For example, the BOP 36-56MG, which has a maximum capacity of  $\pm 36V$ ,  $\pm 56A$ , can be limited to +30V, -10V, +5A, -1A for working with circuitry that might be damaged by higher levels. Once the limits are set, values exceeding the limit values will not be accepted, including external references and protection limits. Refer to PAR. 3.3.4.1.

### 1.6.8 ENERGY RECUPERATION

The BOP is a four-quadrant device as shown in Figure 1-3. Operating as a source, it delivers energy into a passive load, and as a sink it operates as an electronic load, absorbing and dissipating energy from an active load. To minimize energy dissipation, the BOP employs energy recuperation, where energy sunked from an active load is passed backwards through the output circuit and the bidirectional input power factor correcting circuit to the a-c power lines, where it becomes available for reuse. This technology allows high power levels using switch-mode technology while maintaining high efficiency and reduced size and weight.

## 1.7 EQUIPMENT SUPPLIED

Equipment supplied with the BOP power supply is listed in Table 1-3.

**TABLE 1-3. EQUIPMENT SUPPLIED**

ITEM	FUNCTION	PART NUMBER
Source Power Entry mating connector	Mates with source power entry connector	142-0381 (Kepco) (IEC 320)
PAR/SER CONTROL - IN mating connector	Mates with PAR/SER CONTROL - IN port to allow access to pins required for calibration	142-0488 (Kepco)

## 1.8 ACCESSORIES

Accessories for the BOP Power Supply are listed in Table 1-4.



**TABLE 1-4. ACCESSORIES**

ITEM	FUNCTION	PART NUMBER
Mating Connector, Trigger	Mates with Trigger port.	142-0527 (Kepco) SP2501 (CUI Stack)
IEEE 488 Cable, (1 meter long)	Connects BOP power supply to GPIB bus.	SNC 488-1
IEEE 488 Cable, (2 meter long)	Connects BOP power supply to GPIB bus.	SNC 488-2
IEEE 488 Cable, (4 meter long)	Connects BOP power supply to GPIB bus.	SNC 488-4
Line Cord (250V, 20A)	Provides connection to a-c mains via Nema 6-20P connector.	118-1087
Line Cord (250V, 20A)	Provides connection to a-c mains via Nema L6-20P locking type connector.	118-1088
RS 232 Cable Kit	Contains RJ11 to RJ45 Patch cord, RJ 45 Patch cord, two RS 232 adapters, one with male pins to connect to DTE equipment and one with female pins to connect to a PC (personal computer), two RS 232 Loop Back test Connectors (one 6-pin and one 8-pin) to test RS 232 communication and aid in isolating RS 232 communication problems.	KIT 219-0436
RS 232 Adapter (Male pins)	Allows RS 232 port to be connected to DTE equipment. (Supplied in KIT 219-0436.)	142-0487 (L-COM RA098M)
RS 232 Adapter (Female pins)	Allows RS 232 port to be connected to a PC (personal computer). (Supplied in KIT 219-0436.)	142-0506 (L-COM RA098F)
15-pin DSUB Connector	Mating connector for Analog input connector A2A5J6 Dsub 15 pin hood Dsub 15 pin male	108-0374 (Tyco-Amp 207470-1) 142-0449 (Amphenol 17S-DA15P)
IDC 6-pin connector	Mating connector for RS-232 PORT, connector A1J5 and PROTECTION EXT. PORT, connector A2A5J7	142-0536 (Amphenol 5-555176-3)
Heat Sink	Provides adequate cooling for calibration sense resistors.	136-0451
Terminal Cover	Protects against contact with output and barrier strip terminals. Install using the two existing screws (adjacent to two ground terminals) securing rear panel to chassis. Particularly recommended for 72V and 100V models for safety purposes. Consult factory for parallel/series configurations.	129-0423

## 1.9 SAFETY

Service must be referred to authorized personnel. Using the power supply in a manner not specified by Kepeco, Inc. may impair the protection provided by the power supply. Observe all safety precautions noted throughout this manual (see listing on page D, preceding the Table of Contents). Table 1-5 lists symbols used on the power supply or in this manual where applicable.

**TABLE 1-5. SAFETY SYMBOLS**

<b>SYMBOL</b>	<b>Meaning</b>
	WARNING! RISK OF ELECTRIC SHOCK!
	CAUTION: REFER TO REFERENCED PROCEDURE.
WARNING	INDICATES THE POSSIBILITY OF BODILY INJURY OR DEATH.
CAUTION	INDICATES THE POSSIBILITY OF EQUIPMENT DAMAGE.

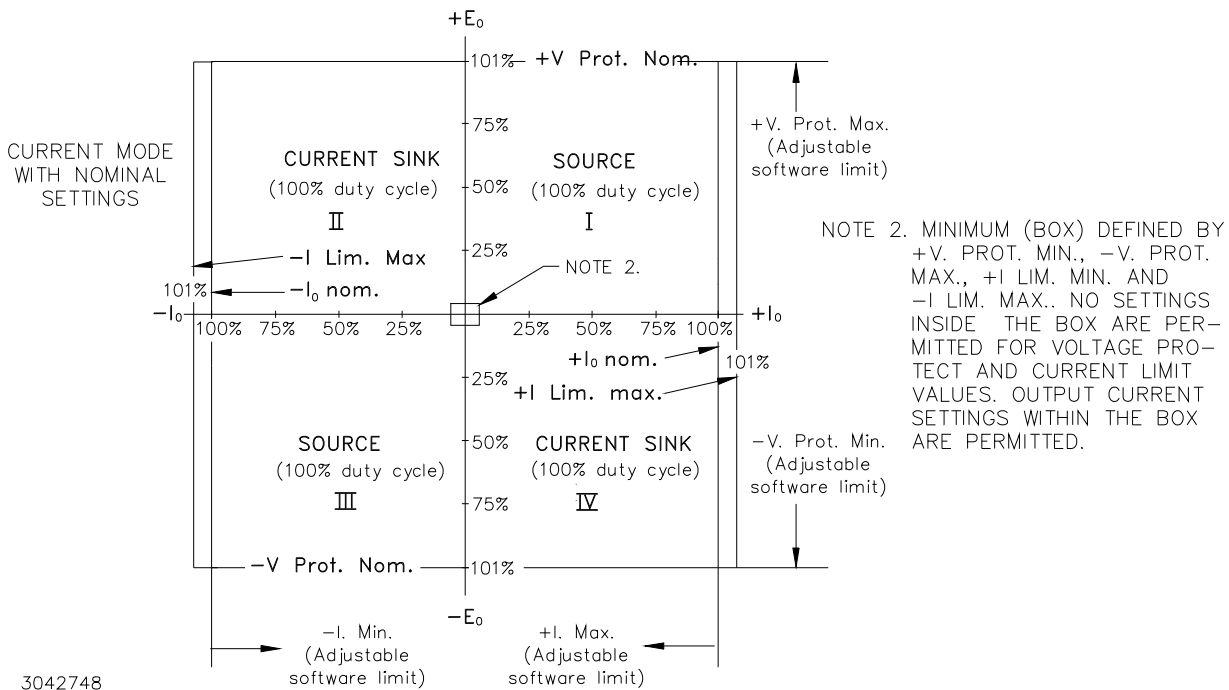
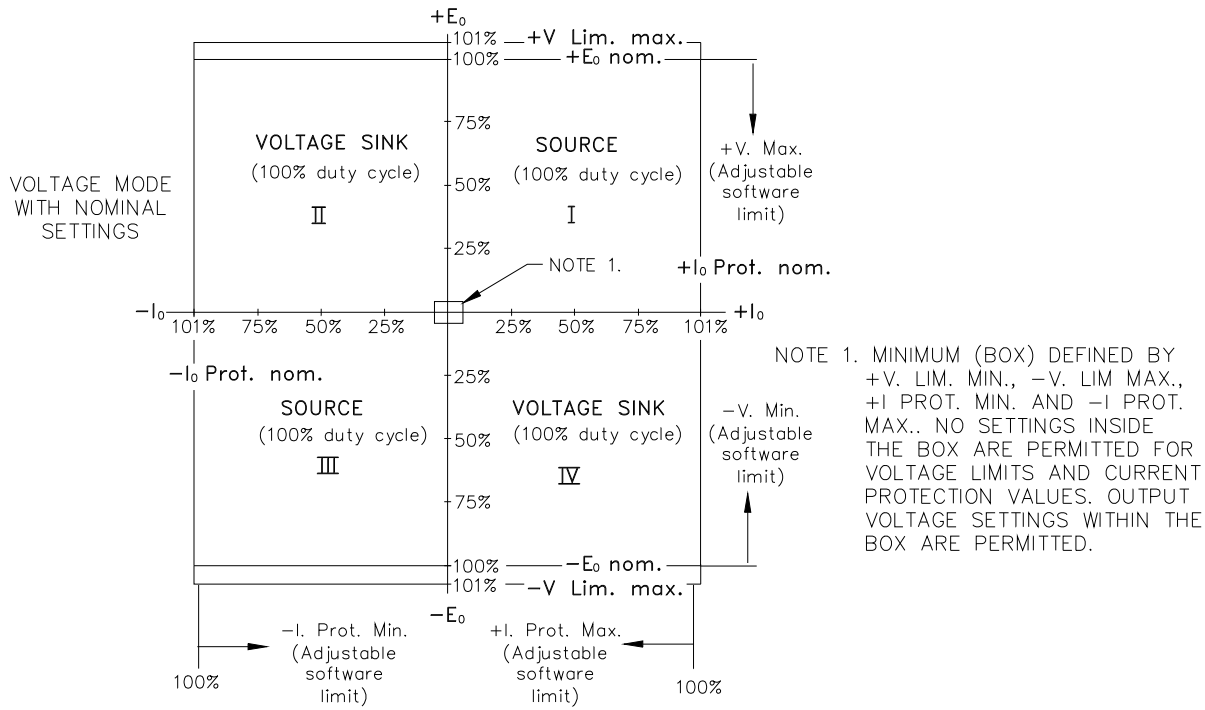

3042748

NOTE 3. The concept of "box value" is illustrated above. It is an area around the origin, where the limits of the unit (voltage or current) cannot be programmed. This minimum (box) value for the positive limits or maximum (box) value for the negative limits, is a model dependent constant of approximately 0.2% of the nominal values for voltage and current. The parameters involved are defined by Note 1 for voltage and Note 2 for current mode, and are further explained in Tables 3-4 and 3-5.

FIGURE 1-3. BOP OUTPUT CHARACTERISTICS



## SECTION 2 - INSTALLATION

### 2.1 UNPACKING AND INSPECTION

This instrument has been thoroughly inspected and tested prior to packing and is ready for operation. After careful unpacking, inspect for shipping damage before attempting to operate. Perform the preliminary operational check as outlined in PAR. 2.3. If any indication of damage is found, file an immediate claim with the responsible transport service.

### 2.2 TERMINATIONS AND CONTROLS

- a) Front Panel: Refer to Figure 3-1 and Table 3-1.
- b) Rear Panel: Refer to Figure 2-1 and Table 2-1.

**TABLE 2-1. REAR PANEL CONNECTOR/TERMINAL BLOCK FUNCTIONS**

NUMBER (FIGURE 2-1)	CONNECTOR/TERMINAL (REFERENCE DESIGNATOR)	FUNCTION
1	IEEE 488 (GPIB) PORT (connector A1J6)	<b>Installed on MG models only.</b> Used for Remote control of the BOP via the IEEE 488 (GPIB) interface (See Table 2-2.)
2	TRIGGER (connector A1J3)	May be used to initiate BOP output. (See Table 2-3.)
3	RS232 PORT (connector A1J5)	Used for Remote control of the BOP via the RS 232 serial interface. (See Table 2-4 for details.)
4	ANALOG I/O PORT (connector A2A5J6)	Installed on MG models only. Provides interface for analog input/output signals. (See Table 2-5.)
5	PROTECT EXT PORT (connector A2A5J7)	Provides means for controlling protection via external circuitry and provides status flags to external circuitry. (See Table 2-6.)
6	LAN PORT	<b>Installed on ME models only.</b> Used for Remote control of the BOP via the LAN interface (see PAR. 3.5.7.4). Indicators for LAN activity and speed are integral to the LAN port. <b>LAN Reset switch</b> is a pushbutton switch that requires a thin tool (e.g., the end of a paper clip) to activate. This switch restores the LAN interface configuration to the factory defaults presented in 3.5.7.1. <b>LAN Indicator</b> - During initialization, the green LAN indicator blinks rapidly while attempting to locate a valid IP address. If successful, the LAN indicator stays on without blinking; When the LAN indicator is not lit it indicates failure to find a valid IP address. This indicator can be intentionally blinked using the ID INSTRUMENT feature of the web-based interface to identify which unit is being accessed in a multi-unit environment. While the LAN indicator blinks, foreground and background colors of the LCD display alternate.
7	 <b>CAUTION:</b> <b>Do not connect load to these terminals; damage to the unit can occur.</b> Monitor and Sensing terminal block	Terminal block provides external connections as follows: OUT S: Sense line connection to load (compensate for voltage drop on connections to load.) See PAR. 2.5.6 and 2.5.7. OUT MON: Monitor connection used to monitor output voltage at power terminals and to implement local sensing. GND: Chassis ground connection. COM MON: Monitor return connection. Used to monitor output voltage at power terminals and to implement local sensing. COM S: Sense line return connection from load. See PAR. 2.5.6 and 2.5.7.
8	OUTPUT Binding Post (red)	Power output connection to load.
9	COM Binding Post (black)	Common - Power output return from load.
10	GND Binding Post (green)	Frame or chassis ground.
11	INPUT Terminal Block	Connects source power to unit. L1 - Line 1, L2 - Line 2 , G - Ground

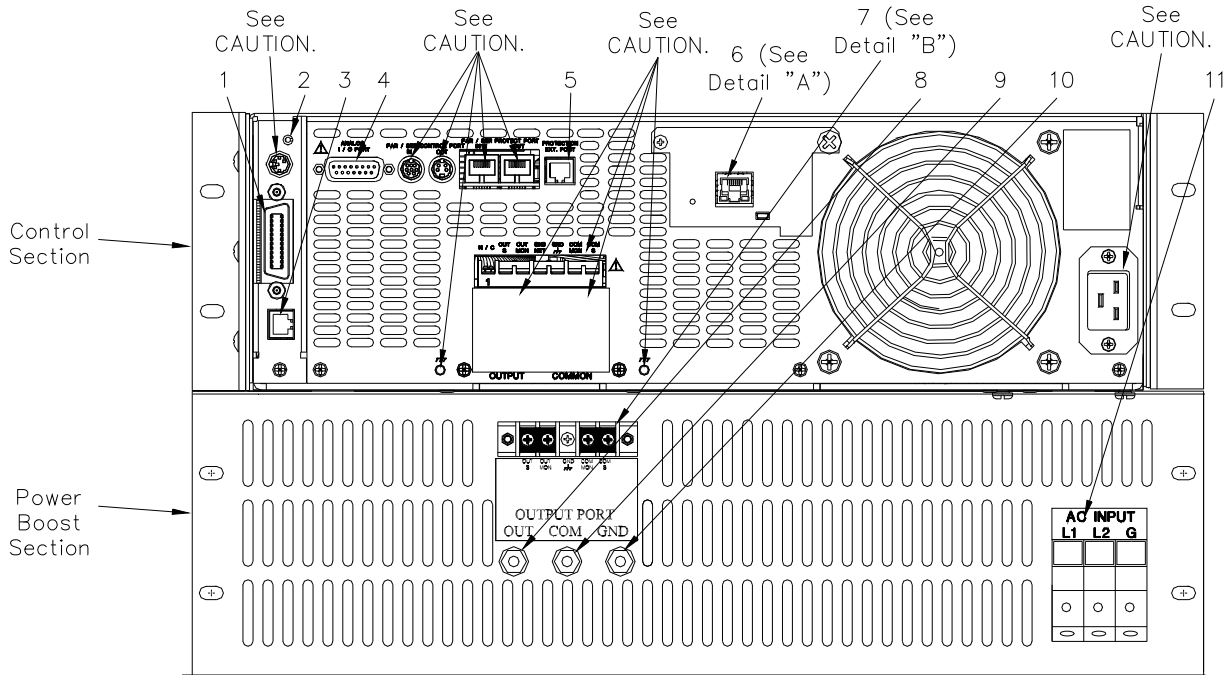

**CAUTION:** Used for internal interconnections. Disconnecting any of these cables will disable the unit.

**IEEE 1118 PORT**

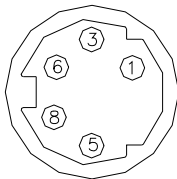

**TRIGGER PORT**

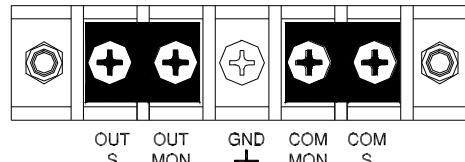
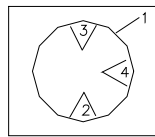

OUT S    OUT MON    GND    COM MON    COM S  
DETAIL A

**RS 232 PORT**

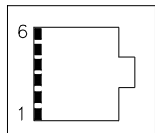

**TRIGGER PORT MATING CONNECTOR**

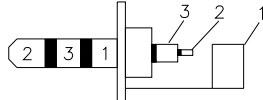

TRIGGER PORT PIN	CORRESPONDING MATING CONNECTOR PIN	LOCATION
1	1	BASE
2	2	TIP
3	N/A	N/A
4	3	MIDDLE

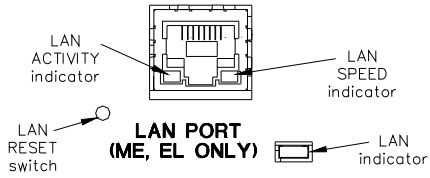

**LAN PORT (ME, EL ONLY)**

DETAIL B

**PROTECT EXT PORT**

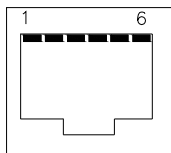

**ANALOG I/O PORT**

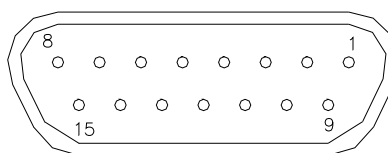

**IEEE 488 PORT (MG, GL ONLY)**

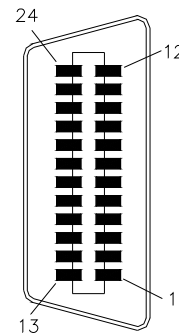

3044386

**FIGURE 2-1. BOP SERIES REAR PANEL (CONTROL SECTION COVER REMOVED)**

**TABLE 2-2. IEEE 488 PORT INPUT/OUTPUT PIN ASSIGNMENTS**

CONNECTOR	PIN	SIGNAL NAME	FUNCTION
IEEE 488 PORT J5	1	DI01	I/O Line
	2	DI02	I/O Line
	3	DI03	I/O Line
	4	DI04	I/O Line
	5	EOI	End or Identify
	6	DAV	Data Valid
	7	NRFD	Not Ready for Data
	8	NDAC	Not Data Accepted
	9	IFC	Interface Clear
	10	SRQ	Service Request
	11	ATN	Attention
	12	SHIELD	Shield
	13	DI05	I/O Line
	14	DI06	I/O Line
	15	DI07	I/O Line
	16	DI08	I/O Line
	17	REN	Remote Enable
	18	GND	Ground (signal common)
	19	GND	Ground (signal common)
	20	GND	Ground (signal common)
	21	GND	Ground (signal common)
	22	GND	Ground (signal common)
	23	GND	Ground (signal common)
	24	LOGIC GND	Logic Ground

**TABLE 2-3. TRIGGER PORT PIN ASSIGNMENTS**

CONNECTOR	PIN	SIGNAL NAME	FUNCTION
TRIGGER PORT (connector A1J3)	1	LOGIC GND	Return for TRIGGER and OUTPUT ON-OFF signals.
	2	OUTPUT ON-OFF	<p>Operation of pin 2 is controlled from either the front panel (PAR. 3.3.6: LowPulse, HighIsOn, LowIsOn, HighIsOff, LowIsOff, OFF) or by OUTP:CONT command (PAR. B.23: LPLS, HON, LON, LOFF, HOFF, OFF).</p> <p>Factory default is LowPulse upon power-up: Logic 0 ((0 volts or short circuit) for at least 100µS disables the output and puts the unit in standby, however Logic 1 (TTL or 5V CMOS level) does NOT enable the output. STANDBY key or a remote OUTP ON command must be used to enable the output. Response to this signal is relatively slow (200mS max).</p> <p>HON: Logic 1 or open (not connected) = output is on (enabled); Logic 0 = output is off (disabled). HON is shown as <b>HighIsOn</b> when configuring from front panel (see PAR. 3.3.6)</p> <p>LON: Logic 0 or short = output is on (enabled); Logic 1 or open (not connected) = output is off (disabled). LON is shown as <b>LowIsOn</b> when configuring from front panel (see PAR. 3.3.6)</p> <p>LOFF: Logic 0 or short = output is off (disabled); Logic 1 does not enable the output; STANDBY key or remote OUTP ON command must be used to enable the output. LOFF is shown as <b>LowIsOff</b> when configuring from front panel (see PAR. 3.3.6)</p> <p>HOFF: Logic 1 or open (not connected) = output is off (disabled); Logic 0 does not enable the output; STANDBY key or remote OUTP ON command must be used to enable the output. HOFF is shown as <b>HighIsOff</b> when configuring from front panel (see PAR. 3.3.6)</p> <p>OFF - Pin 2 is disabled and the unit does not respond to signals applied to this pin. Either OFF or STANDBY is required if using OUTP ON and OUTP OFF commands to control the output.</p>
	3	NOT USED	
	4	EXT. TRIGGER INPUT	Logic 0 causes a trigger event. Logic 1 (TTL or 5V CMOS level) rearms the trigger feature.

**TABLE 2-4. RS232C PORT INPUT/OUTPUT PIN ASSIGNMENTS**

CONNECTOR	PIN	SIGNAL NAME	FUNCTION
RS 232 PORT A1J5	1	RTS	Request To Send (protocol not used)
	2	RXD	Receive Data
	3	TXD	Transmit Data
	4	LOGIC GND	Logic Ground
	5	LOGIC GND	Logic Ground
	6	DSR	Data Set Ready

**TABLE 2-5. ANALOG I/O PORT INPUT/OUTPUT PIN ASSIGNMENTS**

CONNECTOR	PIN	SIGNAL NAME	FUNCTION
ANALOG I/O PORT A2A5J6	 <b>CAUTION:</b> it is recommended that source power of external equipment connected to the Analog Port be applied through an isolating transformer to avoid ground loops or possible damage to the BOP due to incorrect equipment a-c wiring (e.g., defeating of ground connection).		
	1	NC	
	2	VM-/CM	External input signal, TTL logic referenced to pin 9, controls the mode of operation when using external reference (goes to the digital board that changes VM-/CM signal). Logic 0 (or pin grounded) = current mode, logic 1 (or pin not connected, the default) = voltage mode (see PAR. 3.4.3).
	3	IOUT_DMM	Output analog signal through 2K ohm resistor referenced to pin 4 for monitoring overall output current, 0V to ± 10V corresponds to zero to ± full scale current.
	4	SGND	Signal Ground used for IOUT_DMM (pin 3) return.
	5	- I_LIM_EXT	Analog input signal referenced to pin 12, 0V to +10V sets the negative current limit between zero and $-I_{Omax}$ , +10V corresponds to rated maximum current (e.g., for BOP 36-56MG +10V sets negative current limit to -56A) (see PAR. 3.4.5). Open = disabled (see NOTE 1).
	6	- V_LIM_EXT	Analog input signal, 0V to +10V, sets the negative voltage limit between zero and $-E_{Omax}$ , +10V corresponds to rated maximum voltage (e.g., for BOP 36-56MG +10V sets negative voltage limit to -36V). Open = disabled. (See PAR. 3.4.5.) Open = disabled (see NOTE 1).
	7	NC	
	8	NC	
	9	GND	Ground - Used for VM-/CM (pin 2) return
	10	SGND	Signal Ground (used for EXT_REF (pin 11) return
	11	EXT_REF	External analog reference signal referenced to pin 10, used for both voltage mode and current mode, 0V to ±10V corresponds to zero to ± rated nominal (full scale), voltage or current (see PAR. 3.4.4.1).
	12	GND1	Ground (Used for pin 5, 6, 13 and 14 return)
	13	+I_LIM_EXT	Analog input signal referenced to pin 12, 0V to +10V sets the positive current limit between zero and $I_{Omax}$ , +10V corresponds to rated maximum current (e.g., for BOP 36-56MG +10V sets positive current limit to +56A) (see PAR. 3.4.5). Open = disabled (see NOTE 1).
	14	+V_LIM_EXT	Analog input signal, 0V to +10V sets the positive voltage limit between zero and $E_{Omax}$ , +10V corresponds to rated maximum voltage (e.g., for BOP 36-56MG +10V sets positive current limit to +36V. Open = disabled. (See PAR. 3.4.5.) (see NOTE 1).
15	NC		

NOTE 1. When disabled, the external limit channels are automatically set 20% higher than BOP nominal references.

**TABLE 2-6. EXTERNAL PROTECTION CONNECTOR INPUT/OUTPUT PIN ASSIGNMENTS**

CONNECTOR	PIN	SIGNAL NAME	FUNCTION
EXT. PROTECT PORT (connector A2A5J7)	1	SD_EXT_K	Cathode of LED optocoupler (through a 510 ohm resistor) which is used for external isolated shutdown. Anode of LED is connected to (A2A5J7) pin 2. A positive voltage (3.5 to 15V) at pin 2 (referenced to pin 1) shuts down the unit functionality. The unit remains powered, but no output is available and the red front panel FAULT LED will go ON. Response is relatively fast (100µS max.). To resume normal operation it is necessary to cycle power off, then on (preferred) or briefly press the RESET key on the front panel keypad.
	2	SD_EXT_A	Anode of LED optocoupler which is used for external isolated shutdown. (See pin 1 above.)
	3	PG_EXT_C	Collector of optocoupler-transistor which is used for external isolated "power OK" flag. Transistor emitter is connected to (A2A5J7) pin 4. When unit is operating normally, transistor is saturated. Current through transistor should not exceed 5mA and supply voltage should not exceed 15V.
	4	PG_EXT_E	Emitter of optocoupler-transistor which is used for external isolated "power OK" flag. (See pin 3 above.)
	5	EXT_C	Collector of optocoupler-transistor which is used for external isolated "Output OFF" flag. Transistor emitter is connected to (A2A5J7) pin 6. When output is OFF, transistor is saturated. Current through transistor should not exceed 3mA and supply voltage should not exceed 15V. See NOTE below for alternate function.
	6	EXT_E	Emitter of optocoupler-transistor which is used for external isolated "output OFF" flag. (See pin 5 above.)
NOTE: Upon receipt of LIST:SET:TRIG command (PAR B.89), the Output Off flag (EXT_C/EXT_E) no longer represents output on/off state. Instead, this signal can be used to trigger an external device. The transistor state (conducting or not conducting) and the pulse width duration is controlled by the LIST:SET:TRIG command. Upon receipt of LIST:CLE command (PAR B.57) the Output Off flag reverts to representing output on/off status as described above.			

**2.3 PRELIMINARY OPERATIONAL CHECK**

A simple operational check after unpacking and before equipment installation is advisable to ascertain whether the power supply has suffered damage resulting from shipping.

Refer to Figures 2-1 and 3-1 for location of operating controls and electrical connections. Tables 3-1 and 3-2 explain the functions of operating controls/indicators and keypad keys, respectively. Refer to PAR. 3.2 for a description of basic operating techniques.

1. With both control and power boost section POWER switches set to off position, connect the power supply to source power (see PAR. 2.5.2).
2. With no load connected, set both control and power boost section POWER switches to the ON position. Each time the unit is turned on an internal self-test is performed. The alphanumeric display (LCD) shows the processor firmware revision history and lists various tests performed during the internal self-test. As each test is completed, PASS or FAIL is displayed. If all tests pass, the unit goes into the default mode. If a failure occurs, the failure is displayed. Figure 3-4 shows the factory configured power on defaults displayed on the LCD.
3. Connect a digital voltmeter (DVM) (resolution and accuracy of 0.01% or better) to the OUT S and COM S terminals at the rear panel terminal block (7,, Figure 2-1).
4. Use the keypad to enter the rated maximum voltage of the power supply (e.g., enter 36 for a model BOP 36-56MG) and press **ENTER**. If STANDBY indicator is lit, press **STANDBY** key.

- Verify DVM voltage reading agrees with programmed voltage within 0.03% of rated maximum voltage and agrees with displayed voltage on LCD within 0.05% of rated maximum voltage.

## 2.4 INSTALLATION

BOP 2KW models are shipped in a special shipping crate, Kepco P/N 213-0104. Refer to the unpacking/packing instructions included as an Appendix to this manual to unpack the unit without damaging the shipping crate. It is recommended that the shipping crate be retained for future shipment when needed. Once the unit is unpacked, a hoist is recommended to lift the unit from the base (four holes for eyebolts are provided at the top of the cabinet).

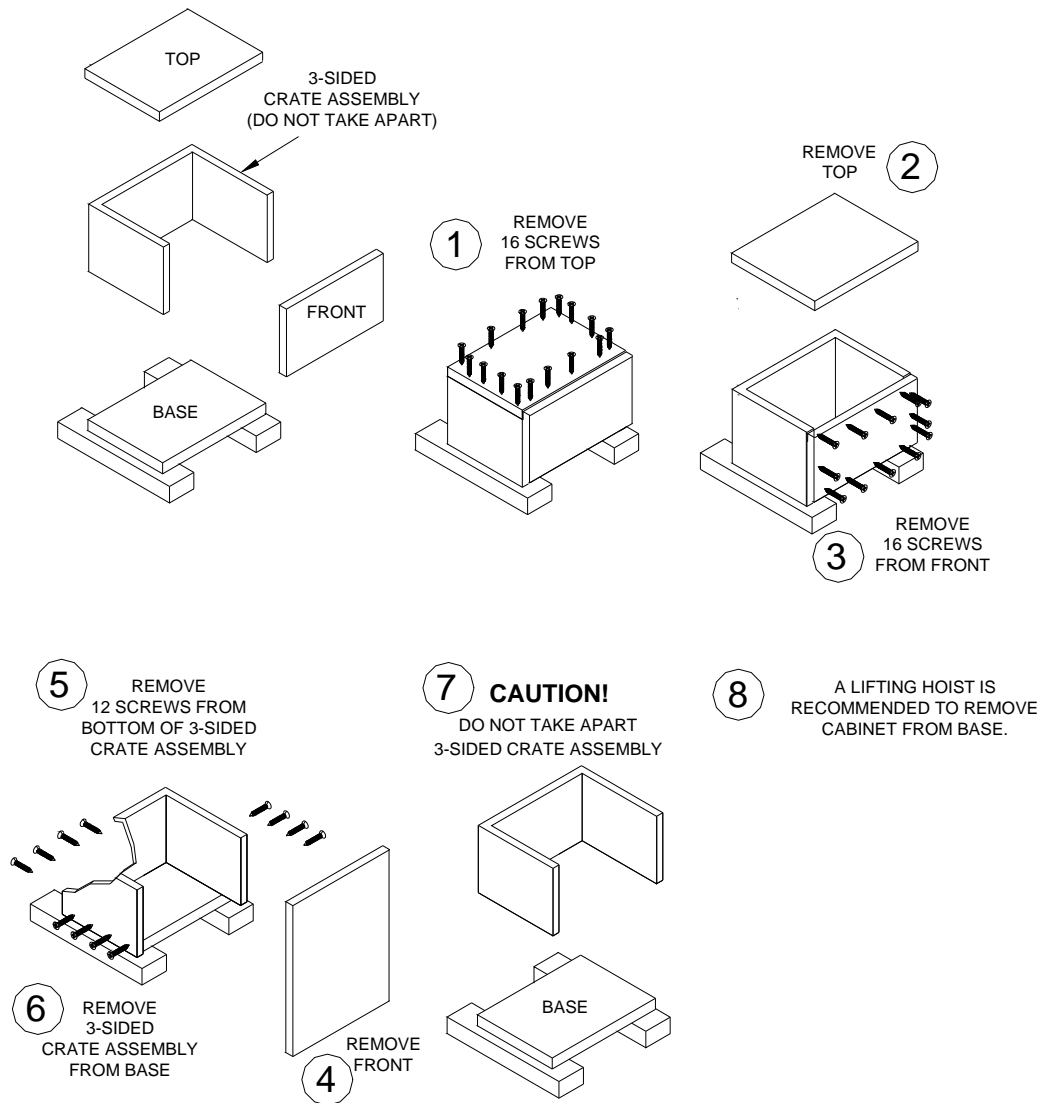

NOTE: AFTER UNIT IS INSTALLED ON THE BASE, PACKING FOR SHIPMENT IS THE REVERSE OF UNPACKING (PICTURED).

3044370

FIGURE 2-2. PACKING/UNPACKING

## 2.5 WIRING INSTRUCTIONS

Interconnections between an a-c power source and a power supply, and between the power supply and its load are as critical as the interface between other types of electronic equipment. If optimum performance is expected, certain rules for the interconnection of source, power supply and load must be observed by the user. These rules are described in detail in the following paragraphs.

A cable access opening is provided at the left side of the control section rear panel (see Figure 1-2) to allow cable connections through the cover. For convenience when making connections to the control section rear panel (Figure 2-1), remove control section rear cover (four screws), thread the cable(s) through the access opening and connect to rear panel as needed, then reassemble rear cover.



**CAUTION: When working with active loads, the voltage or current of the active load must not exceed the maximum voltage or current rating of the BOP. Otherwise the overvoltage or overcurrent protection will shut down the power supply.**

### 2.5.1 SAFETY GROUNDING

Local, national and international safety rules dictate the grounding of the metal cover and case of any instrument connected to the a-c power source, when such grounding is an intrinsic part of the safety aspect of the instrument. The ground terminal of the source power connector (Figure 2-1) is connected to the chassis and the instructions below suggest wiring methods which comply with these safety requirements; however, in the event that the specific installation for the power system is different from the recommended wiring, it is the customer's responsibility to ensure that all applicable electric codes for safety grounding requirements are met. As a precaution, always connect the green binding post marked GND at the rear panel to proper earth ground.

### 2.5.2 SOURCE POWER CONNECTIONS

Source power is connected to the power supply via three-wire input power using the AC INPUT terminals on the rear panel. See Table 1-2 for source power specifications. This power supply operates from single phase a-c mains power (or between two phases of 3-phase a-c mains power) over the specified voltage and frequency ranges (Table 1-2) without any need for range selection. The user must provide a properly sized and rated mains lead (line cord) and service with a current rating compatible with the anticipated input current.

### 2.5.3 D-C OUTPUT GROUNDING

Connections between the power supply and the load and sensing connections may, despite all precautions such as shielding, twisting of wire pairs, etc., be influenced by radiated noise, or "noise pick-up". To minimize the effects of this radiated noise the user should consider grounding one side of the power supply/load circuit. The success of d-c grounding requires careful analysis of each specific application, however, this recommendation can only serve as a general guideline.

One of the most important considerations in establishing a successful grounding scheme is to avoid GROUND LOOPS. Ground loops are created when two or more points are grounded at different physical locations along the output circuit. Due to the interconnection impedance between the separated grounding points, a difference voltage and resultant current flow is superimposed on the load. The effect of this ground loop can be anything from an undesirable



increase in output noise to disruption of power supply and/or load operation. The only way to avoid ground loops is to ensure that the entire output/load circuit is fully isolated from ground, and only then establish a single point along the output/load circuit as the single-wire ground point.

The exact location of the "best" d-c ground point is entirely dependent upon the specific application, and its selection requires a combination of analysis, good judgement and some amount of empirical testing. If there is a choice in selecting either the OUTPUT or COMMON output terminals of the power supply for the d-c ground point, both sides should be tried, and preference given to the ground point producing the least noise. For single, isolated loads the d-c ground point is often best located directly at one of the output terminals of the power supply; when remote error sensing is employed, d-c ground may be established at the point of sense lead attachment. In the specific case of an internally-grounded load, the d-c ground point is automatically established at the load.

The OUT (output) and COM (common) binding posts at the rear panel are d-c isolated ("floating") from the chassis in order to permit the user maximum flexibility in selecting the best single point ground location. Care must be taken in measuring the ripple and noise at the power supply: measuring devices which are a-c line operated can often introduce additional ripple and noise into the circuit.

There is, unfortunately, no "best" method for interconnecting the load and power supply. Individual applications, location and nature of the load require careful analysis in each case. Grounding a single point in the output circuit can be of great importance. It is hoped that the preceding paragraphs will be of some assistance in most cases. For help in special applications or difficult problems, consult directly with Kepco's Application Engineering Department.

### 2.5.3.1 EARTH-GROUND CONFIGURATION

When connecting a programming device to the BOP it is critical that only a single earth-ground point is connected. Figure 2-3 shows proper earth-ground connections for typical configurations, as well as an illustration of the consequences of multiple earth ground points. IF THE FOLLOWING CAUTION IS NOT OBSERVED, ANY DAMAGE TO THE UNIT IS THE USER'S RESPONSIBILITY AND IS NOT COVERED UNDER THE WARRANTY.



**CAUTION:** Never connect the both the load terminal tied to the BOP COM terminal and the programming device common to earth-ground. This allows a ground loop current to flow within the BOP which will compromise accuracy. Catastrophic damage to the BOP will result if the connection between BOP COM and the load terminal connected to earth-ground is lost.

### 2.5.4 POWER SUPPLY/LOAD INTERFACE

The general function of a voltage- or current-stabilized power supply is to deliver the rated output quantities to the connected load. The load may have any conceivable characteristic: it may be fixed or variable, it may have predominantly resistive, capacitive or inductive parameters; it may be located very close to the power supply output terminals or it may be a considerable distance away. The perfect interface between a power supply and its load would mean that the specified performance at the output terminals would be transferred without impairment to any load, regardless of electrical characteristics or proximity to each other.

The stabilized d-c power supply is definitely not an ideal voltage or current source, and practical interfaces definitely fall short of the ideal. All voltage-stabilized power supplies have a finite

source impedance which increases with frequency, and all current-stabilized power supplies have a finite shunt impedance which decreases with frequency. The method of interface between the power supply output and the load must, therefore, take into account not only the size with regard to minimum voltage drop, but the configuration with regard to minimizing the impedance introduced by practical interconnection techniques (wire, bus bars, etc.). The series inductance of the load wire must be as small as possible as compared to the source inductance of the power supply: although the error sensing connection to the load compensates for the d-c voltage drop in the power leads, it cannot compensate for the undesirable output effects of the power lead inductance. These lead impedances (both power and sensing leads) are especially important if the load: is constantly modulated or step-programmed; has primarily reactive characteristics; or where the dynamic output response of the power supply is critical to load performance.

### 2.5.5 LOAD CONNECTION - GENERAL

Load connections require wires that are properly rated for the nominal output current of the unit. Load connections to the BOP power supply are achieved via the OUT (red) and COM (black) binding posts located on the rear panel. A barrier strip is provided at the rear panel for connection of the sense wires to the load (for remote sensing or multiple unit applications). See PAR. 2.5.3.1 and Figure 2-3 for earth-ground recommendations.



**CAUTION:** Never connect the load to the sense terminals. Monitoring instruments (e.g., DVM, etc.) are the only external equipment that may be safely connected to the sense terminals.



**CAUTION:** Never connect the both the load terminal tied to the BOP COM terminal and the programming device common to earth-ground. This allows a ground loop current to flow within the BOP which will compromise accuracy. Catastrophic damage to the BOP will result if the connection between BOP COM and the load terminal connected to earth-ground is lost.

**NOTE** REGARDLESS OF OUTPUT CONFIGURATION, EITHER LOCAL OR REMOTE OUTPUT SENSE LINES MUST BE CONNECTED FOR OPERATION.

1. **OBSERVE POLARITIES:** The **OUT S** sensing wire must be connected to the **OUTPUT** load wire, and the **COM S** sensing wire must be connected to the **COMMON** load wire.

2. IF LOCAL SENSING IS USED, INSTALL LINKS (see Figure 2-4).



**CAUTION:** The safety features incorporated into the BOP to handle energy from Active loads are unable to protect the power supply or the load if input power to the BOP is lost or if the BOP malfunctions. It is recommended that the user monitor "Power OK" flag pins 3 and 4 of the external Protect Port (see Table 2-6) and implement a fast-acting means of disconnecting capacitive loads or crowbarring inductive loads to prevent damage to both the BOP and the load in the event of input power loss.

CORRECT!

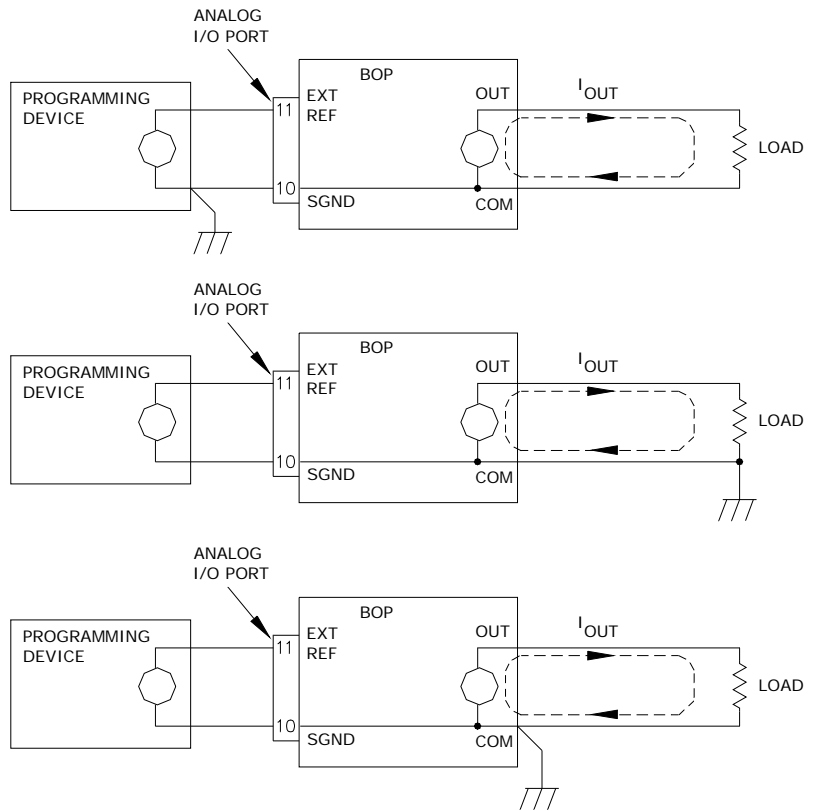

With two earth-ground points as shown, a ground loop allows return current to flow through the internal circuits of the BOP as well as through the proper return path.

WRONG!

With two earth-ground points as shown, if the return connection from the load to BOP COM is missing, all the output current flows through the internal circuits of the BOP causing catastrophic damage to the BOP.

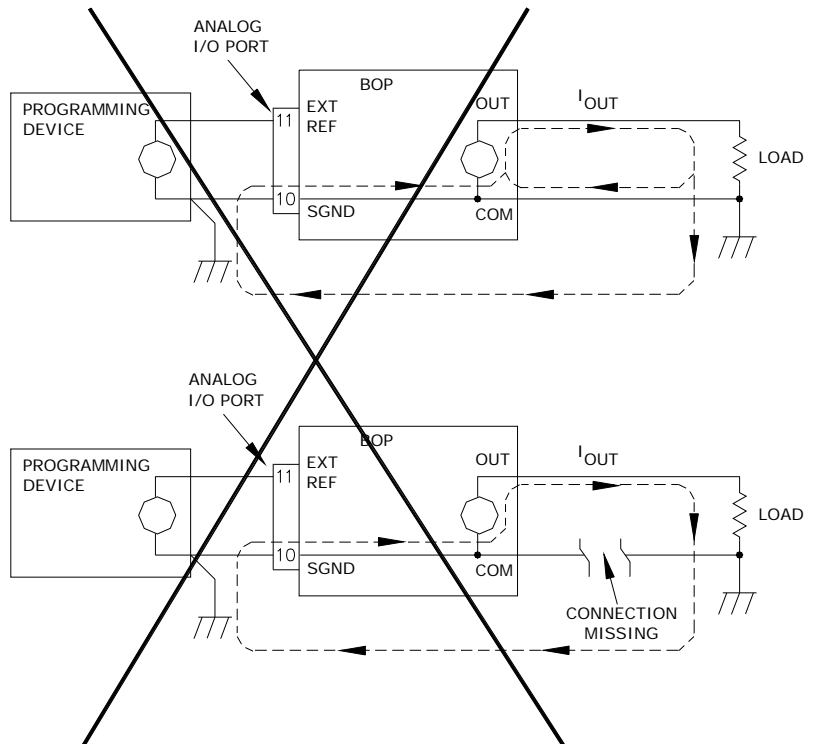

3043801

FIGURE 2-3. EARTH GROUND CONNECTION RECOMMENDATIONS

## **2.5.6 LOAD CONNECTION USING LOCAL SENSING**

Figure 2-4 shows a typical configuration using local sensing and a grounded load; for local sensing with an isolated (“floating”) load, do not install the ground connection (see Figure 2-4, Note 2).

## **2.5.7 LOAD CONNECTION USING REMOTE SENSING**

Figure 2-5 shows a typical configuration using remote sensing and a grounded load; for remote sensing with an isolated (“floating”) load, do not install the ground connection (see Figure. 2-5, Note 2). Use #22 AWG wire, twisted pair for remote sense connections.

## **2.6 COOLING**

The power devices used within the power supply are maintained within their operating temperature range by means of internal heat sink assemblies and by cooling fans. Periodic cleaning of the power supply interior is recommended. If the power supply is located within a confined space, take care that the ambient temperature, which is the temperature of the air immediately surrounding the power supply, does not rise above the specified limits (see Table 1-2).

## **2.7 SETTING UP THE UNIT**

The following paragraphs describe the connections and initial BOP setup needed to operate in the desired mode.

### **2.7.1 CONSIDER THE LOAD TYPE**

The BOP can be configured to respond differently to the Output OFF command, depending on whether the load is defined as Active, Resistive or Battery. Refer to PAR. 3.3.7 to configure this setting.

### **2.7.2 SETUP FOR LOCAL OPERATION**

With all power off, connect the load to the BOP using either local or remote sensing (refer to PAR. 2.5). Then refer to PAR. 3.2 for power supply basics and local operation. The factory default configuration allows local operation with no further setup required.

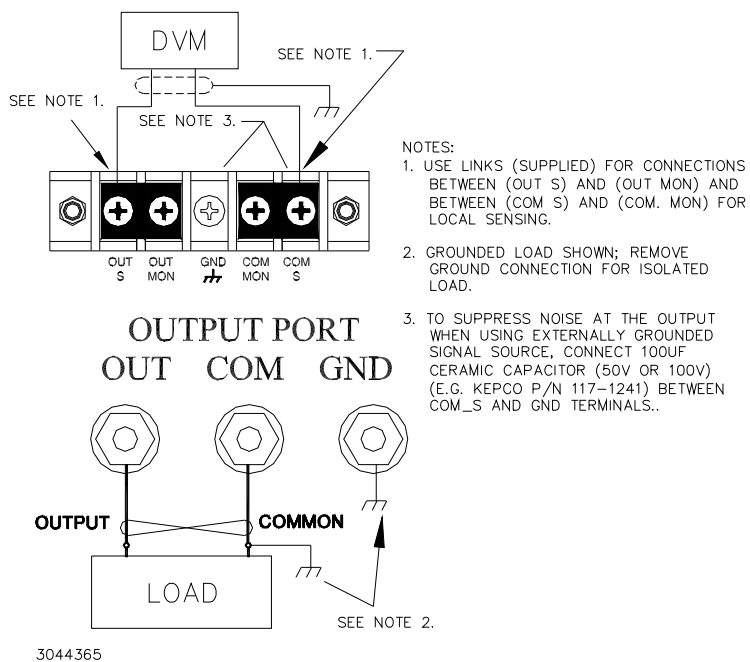

**FIGURE 2-4. LOAD CONNECTIONS, LOCAL SENSING**

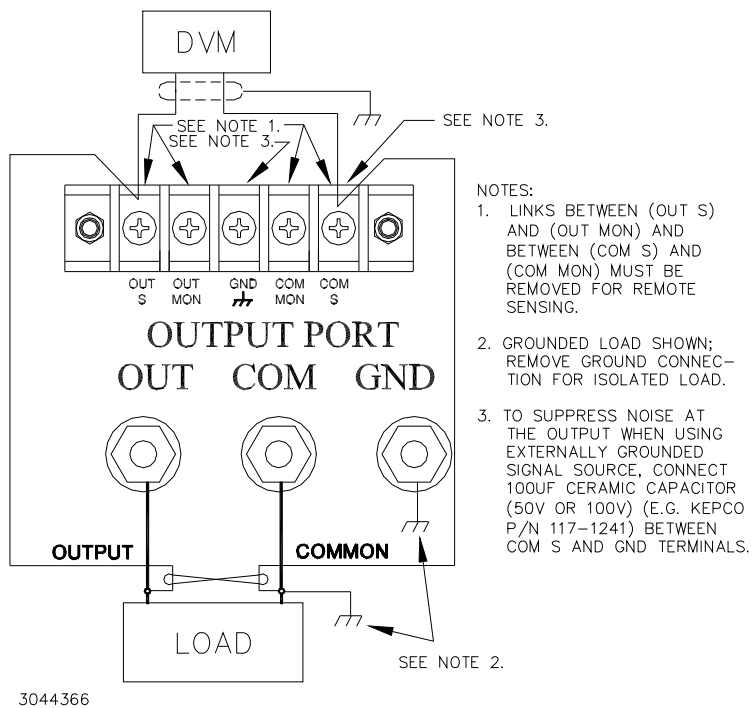

**FIGURE 2-5. LOAD CONNECTIONS, REMOTE SENSING**

### 2.7.3 SETUP FOR FAIL SAFE/INTERLOCK PROTECTION



**This feature requires disassembly and modification of the unit and implementation is permitted only by authorized service personnel.**

To enable the Fail Safe/Interlock Protection feature, refer to the Service Manual to remove the control section. Locate board A2A5 in the control section, then cut or unsolder the test loop wire of TP10 on A2A5.

Once the feature is enabled, a short is required across pins 6 and 7 of the Parallel/Serial Protect In Port for the unit to function (see simplified diagram, Figure 2-6). For example, installing a local jumper across pins 6 and 7 of the Parallel/Serial Protect In Port mating connector will cause the unit to shut down with the red FAULT LED lit if the Parallel/Serial Protect In Port mating connector is disconnected.

Once the unit shuts down, even though power is applied to the input, no transfer of power to the output will occur. To restart the unit it is necessary to either toggle the POWER ON/OFF input circuit breaker on the front panel or, on units with a front panel keypad, press the RESET key.

Another example is to apply the short via a remote NC relay contact closure so that if either the remote relay deenergizes, or the Parallel/Serial Protect In Port mating connector becomes unplugged, the unit shuts down and the red FAULT LED will be lit.

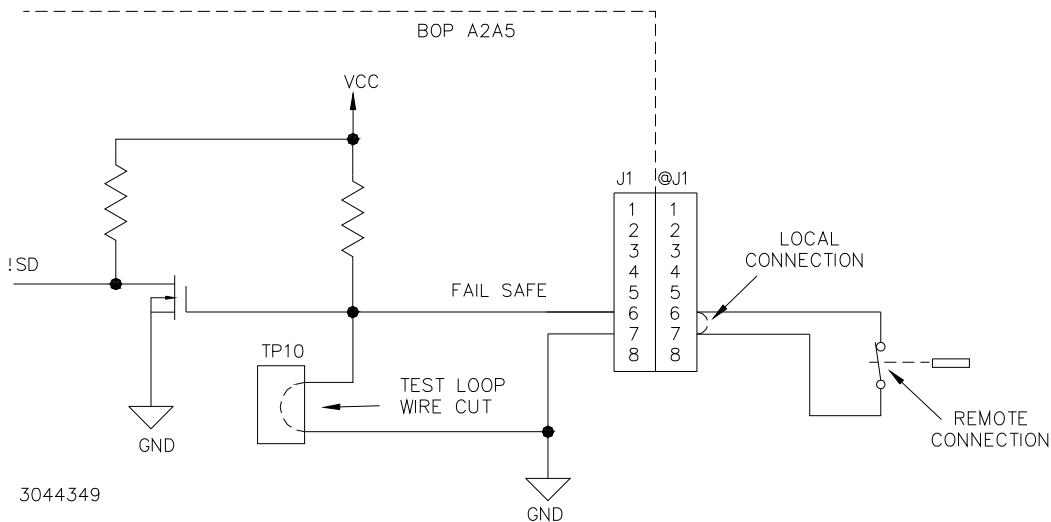

**FIGURE 2-6. FAIL SAFE FEATURE, SIMPLIFIED SCHEMATIC DIAGRAM**

### 2.7.4 SETUP FOR REMOTE OPERATION VIA GPIB (MG MODELS ONLY)

With all power off, connect the load to the BOP using either local or remote sensing. If units are to be connected in series or parallel, refer to PAR. 2.7.6.2. Connect the GPIB connector to the GPIB port (see Figure 2-1 and Table 2-1). Turn power on and refer to PAR. 3.2 for power supply basics and PAR. 3.5 for remote mode programming.



**CAUTION:** To ensure correct operation, do not remove the GPIB cable from the BOP after a Query is processed. Ensure that the last command is a non-query such as \*CLS before removing the GPIB cable. Otherwise, power to the BOP and/or the host computer may need to be cycled OFF then ON to restore proper operation.

The default GPIB address is 6; to change it refer to PAR 3.5.3.2. The default configuration allows both local and remote operation; to prevent local operation once the unit is being controlled from the GPIB, see PAR. B.162. Refer to PAR. 3.5.3.2 to configure the GPIB Port.

SCPI programming is described in PAR. 3.6; Appendices A and B provide syntax for SCPI common and subsystem commands and queries implemented in this unit. All the features described for Local Mode operation can be accomplished using remote SCPI commands.

## **2.7.5 SETUP FOR REMOTE OPERATION VIA RS 232C**

With all power off, connect the load to the BOP using either local or remote sensing (refer to PAR. 2.5). If units are to be connected in series or parallel, refer to PAR. 2.7.6.2. Connect the RS 232 connector to the RS 232 port (see Figure 2-1 and Table 2-1). Turn power on and refer to PAR. 3.2 power supply basics and PAR. 3.5.6 for RS 232 operation. SCPI programming is described in PAR. 3.2; Appendices A and B provide syntax for SCPI common and subsystem commands and queries implemented in this unit. Refer to PAR. 3.5.3.3 to configure the RS 232 Port.

## **2.7.6 SETUP FOR REMOTE OPERATION VIA LAN (ME MODELS ONLY)**

With all power off, connect the load to the BOP using either local or remote sensing (refer to PAR. 2.5). If units are to be connected in series or parallel, refer to PAR. 2.7.6.2.

Connect the BOP to a Microsoft Windows-based computer via the LAN connector (see Figure 2-1 and Table 2-1). Use a standard ethernet cable, whether using a router or hub, or connecting the BOP 2KW directly to a computer. The BOP 2KW-ME is Auto-MDI-X enabled and does not require a crossover cable for direct connection. For Unix and Safari connections see ???

### **2.7.6.1 FINDING KEPCO POWER SUPPLIES ON THE LAN.**

The PSfind utility can be downloaded from the Kepco web site at [www.kepcopower.com/drivers/drivers-dl3.htm#bop1k](http://www.kepcopower.com/drivers/drivers-dl3.htm#bop1k)

This utility finds all operational Kepco power supplies connected to the LAN and then shows the MAC and IP addresses of the models found.

To run the utility from your PC download the psfind.zip file to your computer. Extract psfind.exe from the zip file to a location of your choice, then double-click psfind.exe to run the application. A separate window opens as shown in Figure 2-7. Once the search is completed, all found units are displayed in the Select a Unit window (the MAC address appears in parentheses). If you do not see your device in the **Select a Unit** window or if the icon to the left of the selected instrument is red (not green), make sure it is turned on and connected to the network, then click the **Search Again** button.

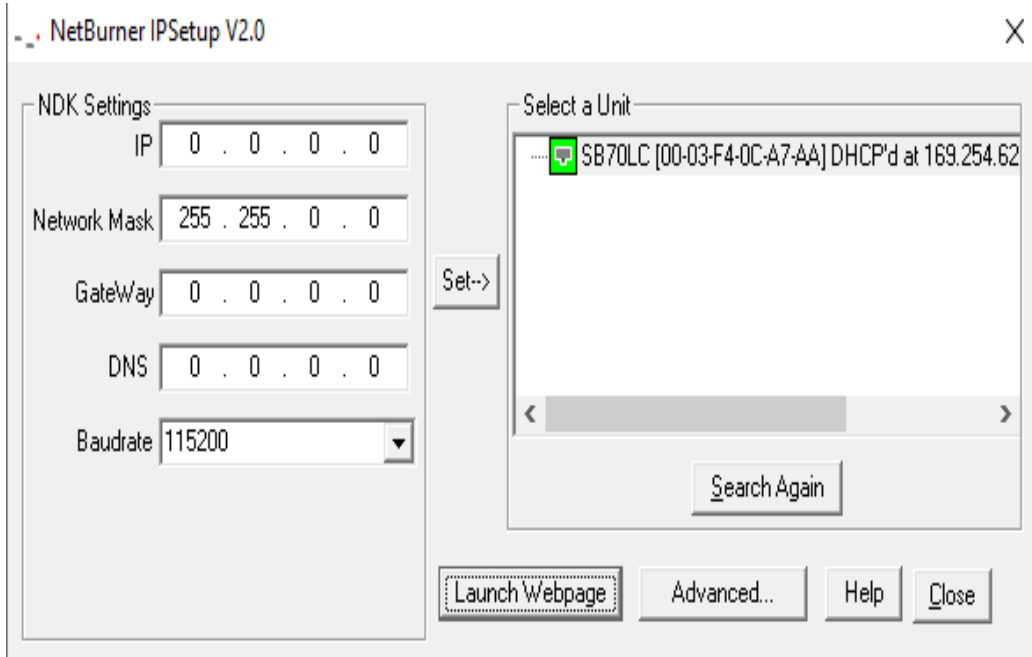

FIGURE 2-7. PS FIND SCREEN

### 2.7.6.2 BONJOUR-ENABLED DISCOVERY

Figure 2-8 shows the BOP 10-200ME found among other Bonjour (MDNS)-enabled devices. Most printers and all LXI Version 1.4-compliant devices support the industry standard discovery methods requiring no user action.

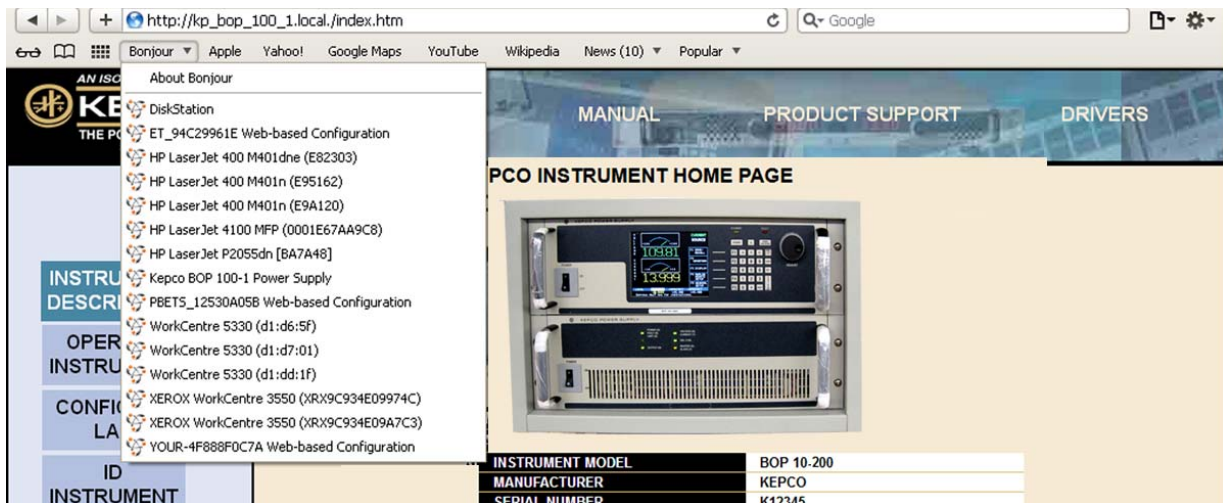
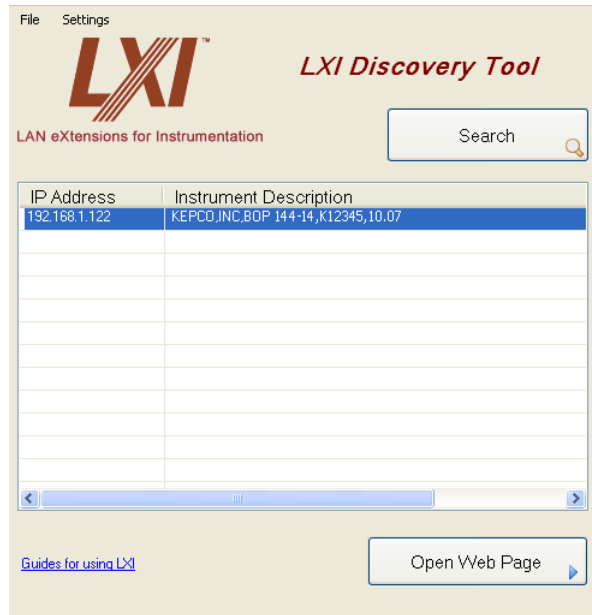

FIGURE 2-8. DISCOVERY USING SAFARI BROWSER WITH BONJOUR INSTALLED

### 2.7.6.3 LXI DISCOVERY

Figure 2-9 shows a Kepeco BOP 144-14ME power supply found on the LAN using the LXI Discovery Tool.





**FIGURE 2-9. TYPICAL SCREEN USING LXI DISCOVERY TOOL**

#### **2.7.6.4 LAUNCH WEB INTERFACE**

After finding the unit and selecting the desired unit on the LAN (see PAR. 2.7.6.1), click the Launch Webpage button to open the BOP 2KW-ME Instrument HOME PAGE (UNIT DESCRIPTION) in your default browser (see Figure 2-10). You can also launch the web page in any browser by entering the IP address as the URL.

**NOTE:** If source power to the BOP 2KW-ME is removed or lost while a browser window is open, communication with the BOP 2KW-ME cannot be restored until the present browser window is closed and a new window is opened.

Upon initial display of the web page, it is good practice to click the browser Refresh/Reload button once to ensure that the power supply information displayed is up to date, and not prior information recalled from the browser cache.

Although most current browsers will work, Kepco recommends the following as fully supported: Safari, IE 8.0 and higher and Firefox 1.0 and higher. Popup blocking must be disabled and Javascript must be enabled for proper operation. If popup blocking is enabled, it may prevent viewing of the help screens.

The BOP 2KW-ME Instrument Home page identifies the unit which has been accessed, including Manufacturer, Instrument, Description, LXI Version (1.4), Serial Number, Calibration Date, Hostname, MAC Address, LXI Firmware Revision and TCP/IP Address. Click the HELP box at the left of the screen for detailed explanations of each. These parameters can not be changed by the user. The hostname ends with .LOCAL if the MDNS has been completely resolved. This feature allows for easy discovery through the MDNS or Bonjour common naming system.

Clicking the ID INSTRUMENT box at the left of the screen, causes the physical LAN indicator on the rear panel of the selected unit to blink (see Figure 2-1), allowing visual confirmation as to which unit is selected. This is especially important if more than one unit is found on the LAN.

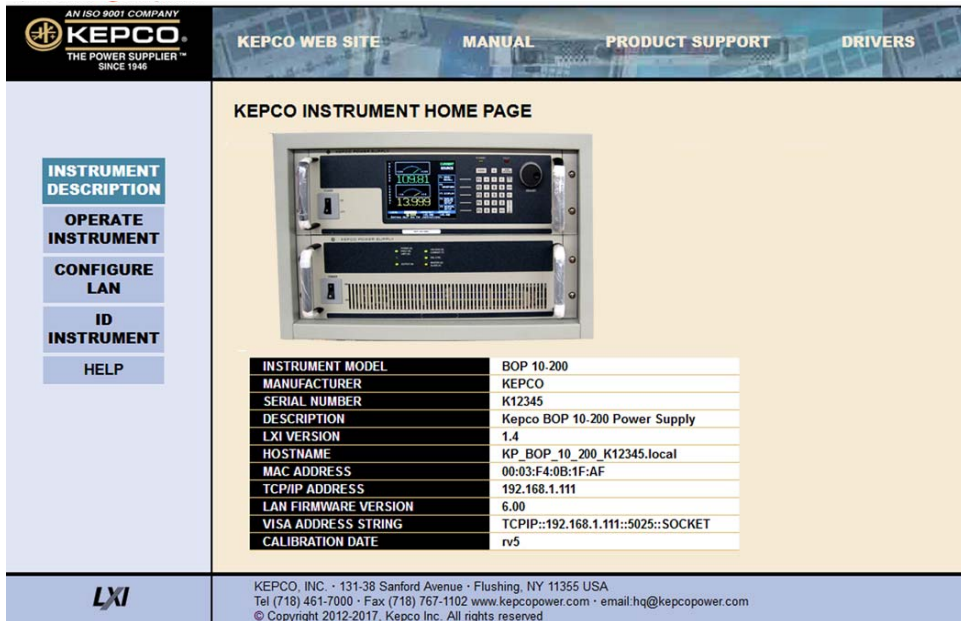

FIGURE 2-10. WEB INTERFACE HOME PAGE (UNIT DESCRIPTION)

### 2.7.6.5 LAN CONFIGURATION USING WEB INTERFACE

From the Web Interface Home Page (Figure 2-10) click on CONFIGURE LAN at the left to view the LAN Configuration page (Figure 2-11). The parameters that can be configured from this page are Host Name (DHCP), Description, IP Address, Subnet Mask address, Default Gateway Address, and DNS Server Address. Separate check-boxes allow enabling of DHCP, AUTOIP and PING. Descriptions of these terms can be viewed by clicking the HELP box at the left. If a data entry fault condition exists, an alert window indicates the type of fault. Click OK to close the window; the SUBMIT button is disabled until the fault is corrected.

There are three passwords shown on this page which control access to the unit . All three web passwords described below are case sensitive.

NOTE: In cases where multiple users are expected to have access to the units, it is recommended that password access be used to restrict *control* of the unit to one user (functioning as a bus controller), while allowing other users viewing access. Allowing multiple users to issue commands to a single unit can cause unpredictable results and may cause the unit to lock up.

- The OPERATE INSTRUMENT password restricts the ability to modify the OPERATE INSTRUMENT page settings. The settings can still be viewed while password protected
- The CONFIGURE INSTRUMENT password restricts the ability to change some INSTRUMENT configuration parameters shown on the CONFIGURE INSTRUMENT page.
- The CONFIGURE LAN password restricts the ability to change the LAN configuration parameters shown on the CONFIGURE LAN page (Figure 2-11.)

**KEPCO LAN CONFIGURATION PAGE**

HOST NAME (DHCP)	KP_BOP_10_200_K12345	
DESCRIPTION	Kepco BOP 10-200 Power Supply	
IP ADDRESS	192.168.1.111	<input checked="" type="checkbox"/> DHCP ENABLED
SUBNET MASK	255.255.255.0	<input checked="" type="checkbox"/> AUTOIP ENABLED
DEFAULT GATEWAY	192.168.1.10	<input checked="" type="checkbox"/> PING ENABLED
DNS SERVER	8.8.8.8	

CHANGE PASSWORD	CURRENT	NEW	REPEAT
OPERATE INSTRUMENT			
CONFIGURE LAN			

Submit      Cancel Changes

KEPCO, INC. · 131-38 Sanford Avenue · Flushing, NY 11355 USA  
 Tel (718) 461-7000 · Fax (718) 767-1102 www.kepcopower.com · email:hq@kepcopower.com  
 © Copyright 2012-2017, Kepeco Inc. All rights reserved

**FIGURE 2-11. WEB INTERFACE CONFIGURE LAN PAGE**

The factory default is that passwords are not needed to access password-protected areas and none of the three passwords are established. To set a password for the first time, leave the CURRENT field blank, enter the new password in the NEW and REPEAT fields, then click SUBMIT. Subsequent changes require the current password to be entered in the CURRENT field. If a password is lost or forgotten, the factory default state (no password required) can be restored by pressing the LAN Reset button on the BOP 2KW-ME (see Figure 2-1 and Table 2-1).

To change a parameter, enter the correct data and/or click the appropriate check-boxes, then click SUBMIT to save the change or NO CHANGE to clear and reload the page without saving. If the data is not entered within 20 seconds after the last keystroke, the data will revert to the previous value. If the LAN CONFIGURATION password was set, you will be prompted to enter the password before the changes are accepted.

When SUBMIT is clicked after new IP address information is entered, the front panel LAN indicator blinks rapidly while the unit validates the IP address. If the address is valid, the browser returns to the INSTRUMENT HOME page (Figure 2-10). If the address entered is already in use, the following note appears towards the top of the page:

NOTE: IP Address is in use.  
 Click CONFIGURE LAN and choose another IP to correct.

An IP address that is not already in use must be entered and submitted, otherwise the browser will lock, requiring the browser to be closed and reopened.



## SECTION 3 - OPERATION

### 3.1 GENERAL

This section explains how to operate the 2000 Watt BOP Power Supply. The power supply can be operated either in Local mode (see PAR's. 3.2 and 3.3) using the front panel keypad, ADJUST control and graphical display, or in Remote mode.

NOTE: Unless otherwise noted, operating instructions start from the power-up screen (see either Figure 3-4 or Figure 3-5). Press  to exit submenus and return to the power-up screen.

Remote mode can either be analog or digital. Analog remote uses analog signals from the Analog I/O port to control the output (see PAR. 3.4).

- **MG Models.** Digital remote (see PAR. 3.5) for MG models uses either the built-in GPIB (IEEE 488) (see PAR. 3.5.4) or RS 232 (see PAR. 3.5.6) interface to communicate with a remote computer. GPIB or RS 232 communication is via one of two protocols: 1) SCPI commands which afford full functionality of the BOP (see PAR. 3.6, Appendix A and Appendix B) or 2) CIIL commands (for compatibility with older Kepco products). MG model operation in remote mode can be simplified by the use of the VISA driver (see PAR. 3.5.5).
- **ME Models.** Digital remote for ME models uses either the built-in LAN (see PAR. 3.5.7) or RS 232 (see PAR. 3.5.6) interface to communicate with a remote computer. RS 232 communication is via one of two protocols: 1) SCPI commands which afford full functionality of the BOP (see PAR. 3.6, Appendix A and Appendix B) or 2) CIIL commands (for compatibility with older Kepco products). LAN communication uses SCPI commands.

### 3.2 POWER SUPPLY BASICS

The following paragraphs describe basic operation of the front panel controls, which are used to configure and operate the power supply. This includes a description of the keypad (PAR. 3.2.1), graphical display (LCD (PAR. )), how to turn the unit on (PAR. 3.2.3), how to change the power-up defaults (see PAR. 3.3.8). An explanation of the BOP menu (PAR. 3.2.4) provides basic techniques needed to use the ADJUST control and the function, arrow and numeric keys in conjunction with the LCD to operate the power supply. Operator convenience functions (LCD background and contrast, and the audible beep) are described in PAR. 3.2.5. Refer to Table 3-1 and Figure 3-1 for a description of front panel controls and indicators.

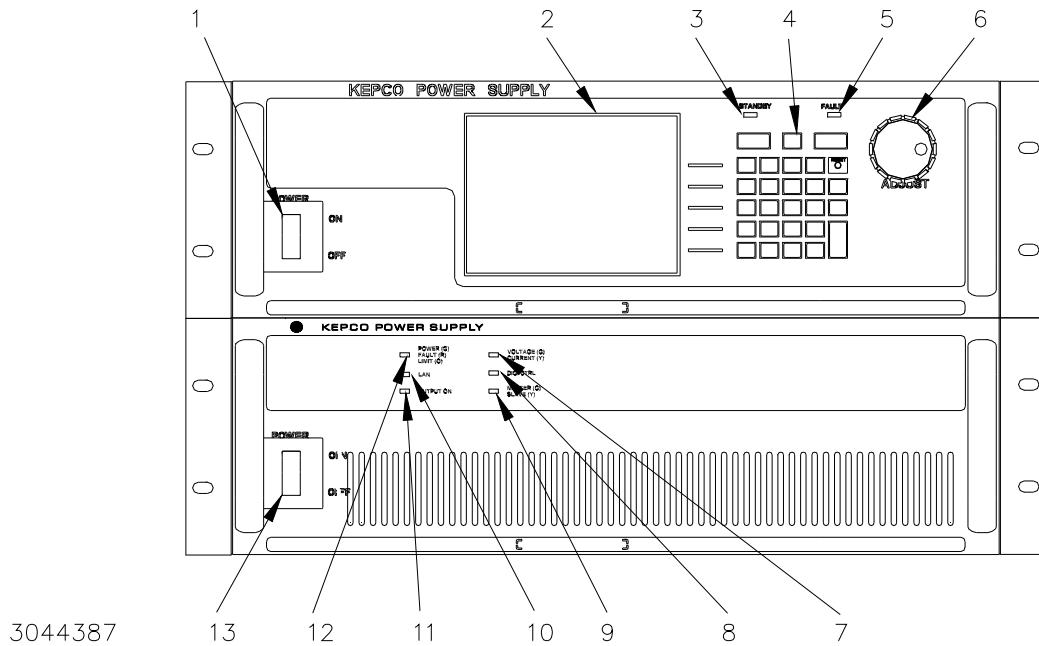



**FIGURE 3-1. BOP SERIES FRONT PANEL**







**TABLE 3-1. FRONT PANEL CONTROLS AND INDICATORS**

NUMBER (FIGURE 3-1)	CONTROL/INDICATOR	FUNCTION
1	POWER ON/OFF circuit breaker	Applies source power to Control Section
2	Alphanumeric/graphic Display (Color LCD)	Displays output voltage and current as well as information in response to keypad and ADJUST control entries. Displays function of soft function keys F1 through F5, and displays information as required to perform all local functions.
3	STANDBY indicator	Lights to indicate when the unit is in Standby mode. Behavior of the unit in Standby (Output off) is determined by the options chosen for Load Type (see PAR. 3.3.7). If the Load Type is ACTIVE (default), then in Standby mode the unit is set to voltage mode, voltage is set to zero, current protection is set to the nominal, and voltage limit is set to maximum.
4	Keypad	Access all local functions (see PAR. 3.2.1, Figure 3-2 and Table 3-2 for details).
5	FAULT indicator	Lights when a fault is detected. The failure of the following assemblies cause the FAULT indicator to go on: A1 (any control function failure), A2 (overtemperature, instant internal overcurrent, output overvoltage/overcurrent, local +15V failure), A4 (input under/overvoltage, input overcurrent, internal output under/overvoltage, internal output overcurrent, overtemperature, fan failure, local -15V failure). When the FAULT indicator lights, the LCD will briefly display messages about the fault (see Table B-6, Appendix B for details), however the FAULT indicator remains lit. When the fault has been removed, normal operation is restored by cycling power off, then on (preferred) or by briefly pressing the RESET key on the front panel to initiate a shut down and power up sequence (see RESET key, Table 3-2).

**TABLE 3-1. FRONT PANEL CONTROLS AND INDICATORS**

NUMBER (FIGURE 3-1)	CONTROL/INDICATOR	FUNCTION
6	ADJUST control	The control Increases or decreases the highlighted digit of numeric fields (use  or  to change the highlight). When depressed, the control Increases or decreases the least significant digit of numeric fields. If the output is enabled, voltage and current adjustments are immediately present at the output without pressing <b>ENTER</b> . For alphanumeric fields, the control cycles through all alphanumeric and symbol characters. (use  to highlight the next character and press <b>ENTER</b> when complete). On submenus the control highlights parameter of interest.
7	Mode of Operation VOLTAGE/CURRENT status indicator	LED flashes during power-up. Lights green for VOLTAGE mode. Lights YELLOW for CURRENT mode.
8	DIG. CTRL status indicator	LED lights green for digital control. Not lit for analog control
9	MASTER/SLAVE status indicator	LED always lights yellow for Slave.
10	LAN indicator	LED functions only for ME and EL models. During initialization, the green LAN indicator blinks rapidly while attempting to locate a valid IP address. If successful, the LAN indicator stays on without blinking; When the LAN indicator is not lit it indicates failure to find a valid IP address. This indicator can be intentionally blinked using the ID INSTRUMENT feature of the web-based interface to identify which unit is being accessed in a multi-unit environment. While the LAN indicator blinks, foreground and background colors of the LCD display alternate.
11	OUTPUT ON status indicator	Provides output status. LED lights green when output is on. Not lit when output is off (disabled).
12	Unit Status POWER/FAULT/LIMIT indicator	LED lights green for POWER GOOD, lights red for FAULT, lights orange for LIMIT.
13	POWER ON/OFF circuit breaker	Applies source power to Power Boost Section

**3.2.1 KEYPAD DESCRIPTION (SEE FIGURE 3-2)**



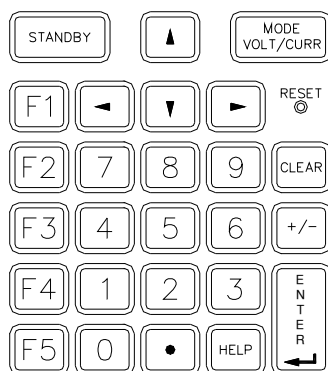





The front panel keypad is comprised of 27 keys, eleven for 10 digits (0 - 9) plus decimal point, five dedicated to software functions ( to ) indicated by the display, four direction keys (, , , ) that work with the display to select a parameter/field and highlight a numerical digit, and seven dedicated function keys (STANDBY, MODE, RESET, CLEAR, +/-, ENTER and HELP) that are defined in Table 3-2.



3042534

FIGURE 3-2. FRONT PANEL KEYPAD

TABLE 3-2. SPECIAL KEY FUNCTIONS

KEY	FUNCTION
STANDBY	The STANDBY key toggles the unit between output on (enabled, STANDBY indicator off) and output off (disabled, STANDBY indicator on). When on, the output goes to the programmed settings. Behavior of the unit in Standby (Output off) is determined by the options chosen for Load Type (see PAR. 3.3.7). The default Load Type is ACTIVE, i.e., in STANDBY the unit is set to voltage mode, voltage is set to zero, current protection is set to the nominal, and voltage limit is set to maximum.
MODE	Depressing this key shifts the operating mode from voltage to current and vice versa, and at the same time sets the unit to STANDBY permitting the user to introduce new settings for the selected operating mode. The operating mode is indicated at the upper right of the LCD. Setting the unit to STANDBY when the mode is changed only occurs when using the MODE key.
 or 	From the power-up screen, these keys scroll the cursor from digit to digit within a field.
 or 	From the power-up screen, these keys scroll through the main or protection fields. Also used to scroll through and select options on other menus.
CLEAR	Clears numeric value to 0 (zero). Clears alphanumeric characters for new entry.
+/-	Switches the sign between + and – when inputting numerical values. The sign change applies only to the main channel: voltage in voltage mode, current in current mode. <b>CAUTION: Pressing +/- key while the power is applied to the load will reverse the polarity of voltage applied to the load.</b> 
ENTER	Activates highlighted parameters. When setting voltage/current values using the keypad, the values entered are not programmed until ENTER is pressed.
HELP	Provides context-sensitive help to assist in using the keypad and display to program the unit. Press HELP repeatedly for more help messages.
 through 	The “soft” function keys are software dependent, and will change depending on the operation being performed. The key function is indicated by a box in the LCD which is aligned with the key (see PAR. ).
RESET switch	Switch is recessed and requires the use of a tool to prevent inadvertent activation. Pressing RESET briefly causes the unit to shut down followed by execution of a power on sequence which results in the unit being set to the power on defaults (see PAR. 3.3.8). To restore normal operation after a fault has been cleared it is recommended that the unit be powered off, then on again instead of using the RESET key. <b>CAUTION: Pressing RESET will cause voltage transients to appear at the output which may damage a connected load.</b> 



### 3.2.2 LCD AND POWER-UP SCREEN DESCRIPTION

The LCD display is a 320 x 240 pixel color window that displays various menus depending on the state of the power supply and operator input.

Upon turning the unit on, the start-up screen (Figure 3-3) is displayed briefly, showing the firm-ware versions of the BOP processors and the results of the start-up self test.

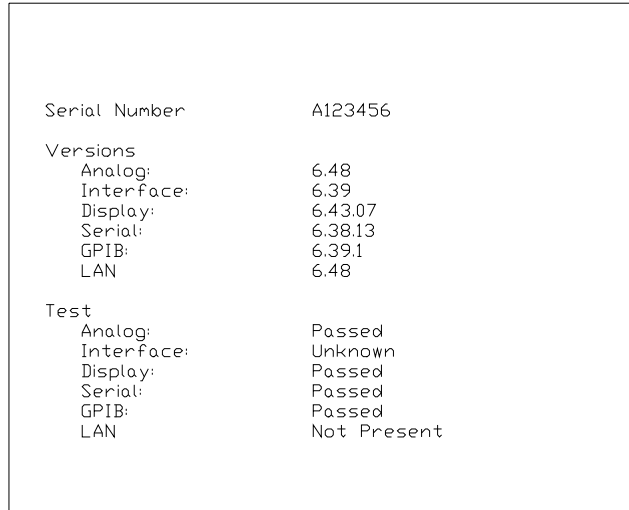

3042519-18

**FIGURE 3-3. START-UP SCREEN**

After the start-up screen, the power-up screen (Figure 3-4 or Figure 3-5) is displayed. The LCD will show actual voltage and current at the BOP output, the mode (at the upper right), the function of the soft keys to the right, help text at the bottom, and main and complementary limit channel settings above the help text. The power-up screen is presented upon power-up or when all submenus of a function have been exited. This screen shows analog and digital representations of the actual BOP output in the center of the display.

At the upper right of the display, the mode of operation is displayed:

- Voltage source
- Voltage sink
- Current source
- Current sink

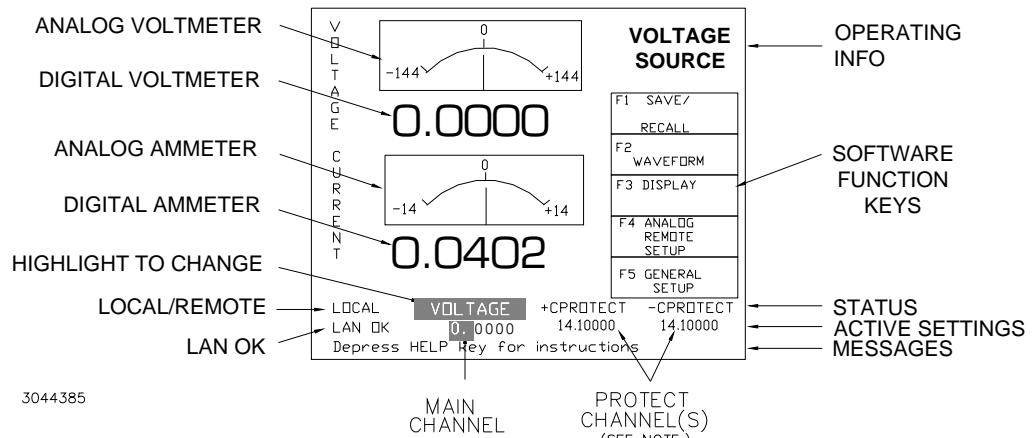

NOTE:  
 WHEN SET TO BIPOLAR, ONLY ONE PROTECTION FIELD IS DISPLAYED.  
 WHEN SET TO INDEPENDENT, TWO PROTECTION FIELDS ARE DISPLAYED AS SHOWN HERE.  
 WHEN SET TO BIPOLAR, ONLY ONE PROTECTION FIELD IS DISPLAYED.  
 WHEN SET TO INDEPENDENT, TWO PROTECTION FIELDS ARE DISPLAYED AS SHOWN HERE.  
 SEE PAR. 3.3.3.1 FOR DETAILS.

FIGURE 3-4. POWER-UP SCREEN SHOWING GRAPHIC METERS

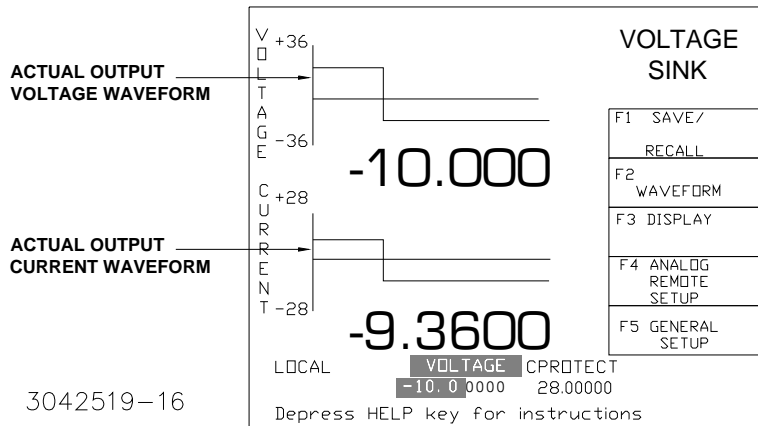

FIGURE 3-5. POWER-UP SCREEN SHOWING TIME LINE GRAPH

The OPERATING INFO found in the upper right of the display consists of three lines. The Selected mode of operation is shown on the top line. If the unit is providing power to the load (SOURCE) or absorbing power from the load (SINK), this is displayed on the Middle line. If the the unit is at a protection limit, the third line is displayed.

When in Voltage mode, the power supply will (within the configured and rated limits) provide the programmed output voltage. Mode displayed at the upper right is VOLTAGE. Current is determined by the load, and cannot exceed the Current Protect limits. If the protect limit is reached, CPRTECT is displayed; if protect limit has not been reached this line is blank.

When in Current mode, the power supply will (within the configured and rated limits) provide the programmed output current. Mode displayed at the upper right is CURRENT. Voltage is determined by the load, and cannot exceed the Voltage Protect limits.

Either SOURCE or SINK is displayed below the mode of operation. When in Source mode, the power supply is delivering (sourcing) energy to a passive load. When in Sink mode, the power supply is operating as an electronic load, absorbing and recuperating the energy of an active load. Recuperated energy is passed back into the a-c source power line. Mode displayed at the upper right is SINK when the unit is in voltage mode and an external constant current is injected into the BOP. Correspondingly, SINK is displayed when the unit is in current mode and an injected current from an external constant voltage is presented at the output of the BOP. These messages are normally displayed briefly when voltage is decreased towards zero, and may also be displayed briefly during changes in a capacitive load.



If CPROTECT (current protection), VPROTECT (voltage protection) or PROTECT (analog protection, either voltage or current) is displayed, the power supply output is controlled by the protect channel and will not exceed the preprogrammed protection limit.

The bottom lines of the display provide STATUS, ACTIVE SETTINGS and MESSAGES (including error messages).

STATUS includes whether the unit is under local or remote control, identifies the main and protect channels and, if the LAN interface is installed, LAN OK is visible when the LAN indicator on the LAN port is lit (see Figure 2-1 and Table 2-1). When the LAN indicator is blinking, LAN OK blinks, and the foreground and background colors of the LCD display will alternate. The protect channel will show either a single entry for both positive and negative VPROTECT or CPROTECT or separate entries for + and – VPROTECT or CPROTECT. This is established by selecting either Bipolar or Independent for Protect Entry (see PAR. 3.3.3.1).

ACTIVE SETTINGS show the values that will be applied to the respective channel. The highlighted settings are used to program the unit and can be changed using the keypad or **ADJUST** control after highlighting. If these are changed using the keypad, the **ENTER** key must be pressed to program the unit; if the **ADJUST** control is used, the changed setting immediately programs the unit without pressing **ENTER**. If the main channel indicates CURR-EXT or VOLT-EXT, the setting establishes the full scale output corresponding to a 10V analog signal (see PAR, 3.4.4.2). If the main or protect channel indicates EXTERNAL, the corresponding setting is determined by an analog reference (see PAR. 3.4.4.1).

MESSAGES change depending on the particular screen being displayed. Error messages are displayed for both local and remote operation, and only appear briefly.

At the right of the display, five graphic boxes indicates the active function of the soft function keys,  through . Depressing the corresponding key on the keypad activates the function shown on the display. These functions are arranged in a menu format (see PAR. 3.2.4).

### 3.2.3 TURNING THE POWER SUPPLY ON



**CAUTION: DO NOT repeatedly toggle the circuit breaker/switch as this may damage the unit.**

Set POWER ON/OFF circuit breaker/switches (1 and 13, Figure 3-1) on front panel to ON. If either actuator does not lock when released, wait a few seconds before trying again. The circuit breaker is “trip-free” design; if overload exists, contacts cannot be held closed by actuator.

When the power supply is turned on, it performs a brief self-test that includes testing the three processors (analog, interface and display), then displays the power-up screen (see Figure 3-4 or 3-5). If an error is detected, the FAULT indicator will light, information about the error will be briefly displayed on the LCD.

If the unit powers up in REMOTE mode, press **F1** (see PAR. 3.3.1) to set the unit to LOCAL mode.

To select between the meter (Figure 3-4) and time line (Figure 3-5) displays refer to PAR. 3.3. To change the default power-up settings, refer to PAR. 3.3.8.

### 3.2.4 HOW TO ACCESS THE MENUS





From the power-up screen, pressing the Function key indicated on the LCD opens the associated menu. The menu opened may list submenus that may be opened either directly by pressing the associated Function keys, or by highlighting an item on the list and pressing the Modify Settings function key. Menus and submenus will display a list of parameters, with one highlighted. The function key assignments can vary, but generally offer the following choices:

- **F1** allows the highlighted parameter to be viewed or modified. After changing the parameter, the following choices are available.
  - **F4** - APPLY to save the change
  - **F5** - ABORT to abort the change and exit to the previous menu.
  - **F2** - DEFAULT to restore the variable to factory defaults.
  - Illegal keys, such as **F1**, cause error messages to be displayed in the status line for a short period of time.
- **F2** - RESTORE DEFAULT restores factory defaults for the parameters displayed (except for GPIB address). The factory defaults may be saved as power-up defaults by pressing **F4**.
- **F3** - The function varies, depending on the menu. In most cases **F3** is used to abort a change without applying the modified setting. From the power-up screen or the DISPLAY (Operator convenience) screen, **F3** is used to adjust contrast. In the Revisions/TEST submenu of the General Setup Menu, **F3** is used to execute a test.
- **F4** - SAVE FOR POWER-UP Saves the configuration shown as a power-up setting so the changes will not be lost when the unit is turned off.
- **F5** - APPLY & EXIT applies the current (changed) setting without saving for power-up and exits to the previous menu or to the power-up screen, EXIT leaves the current menu without saving or applying changes.

The menu structure is as follows (NOTE: **BOLD** = Factory Default):





Power-up Screen (Power up menu)





















- **F1** - Save/Recall
- Saved Setups (Figure 3-10): Recall one of 99 saved setups.
- • • Saved Setup Details (Table 3-9): Mode (voltage/current/External), main channel reference (internal/external/external reference level) and setting, Protection Type (internal/external/LesserLimit) and setting(s), output status (on/off)

-  - Waveform
  - Saved Waveforms (Figure 3-11): Choose one of 16 saved waveforms.
  - New Waveform Settings (Table 3-13): Name (max. 10 characters), mode (voltage/current) No. of cycles, +Protect, -Protect)
    - First segment: type (Square/ +ramp /-ramp/triangle/sine/level), Frequency, PtoP Amplitude, Offset
  - Edit Waveform (Figure 3-12): Name, no. of cycles, +protect, -protect, segment list, mode
  - Segment Details (Table 3-12): Type ((Square/+ramp/-ramp/triangle/sine/level/slope/trigger), frequency or period, amplitude, offset, start/stop angle for sine and triangle, Repeat (initial/repeat)
-  - Display
  - Display Settings (Table 3-3): Graphic Display (**meters**/graphics, background (**black**/white/mono-black/blue/green/lt.green/ lt.blue), Protect Entry (**independent**/bipolar) Waveform Stop (**outputOFF**/User Option), Key Press beep (**On**/Off/Error only)
-  - Analog Remote Setup (Table 3-16):
  - Analog Remote Settings: Reference input (**internal**/external/external reference level), protect limit (**Internal**/External/LesserLimit), external mode (**disable**/enable)
-  - General Setup
  - Interface Settings (Table 3-17):
    - \*RST set Output (**on**/off),
    - GPIB Settings (Table 3-17): Language (**SCPI**/CILL), GPIB address (default = **6**), Device clear (**SCPI**/MATE)
    - Serial Settings (Table 3-17): Baudrate (**Off**/9600/19200/38400), Xon/Xoff (**disable**/enable), prompt (**disabled**/**echo**/enabled/enab+echo)
    - LAN Setting (Table 3-18): IP Address, IP MASK, AUTO IP **ON**, DHCP **ON**, Name and index (MDNS name)
  - Max/Min Settings (Table 3-5): for voltage mode: +Voltage max, -Voltage min, ±CProtect max/min; for current mode: +Current max, -Current min, ±VProtect max/min
  - Load Type (Figure 3-8): **Active**/Resistive/Battery, Remote On-off: (disabled/high is off/low is off/high is on/low is on/LowPulseOff)
  - Remote On/Off (Shutdown or Output On/Off) Operation (Table 2-3): **LowPulse**, HighIsOn, LowIsOn, HighIsOff, LowIsOff, Disabled
  - Revisions/Test: (Tests: display, keypad, LAN, interface, serial, analog and output)
  - Calibration (PAR. 4.4): Voltage, Current and External and Controls calibration. Shows Firmware versions for Display, Serial, GPIB, LAN and analog.
  - Power-up Settings (PAR. 3.3.8): Mode (**Voltage**/Current/External), Main channel Reference (**Internal**/External/ExtlRefLev), main setting, Protection: Type (**Internal**/External/LesserLimit), Voltage Limit (current mode), Current Level (voltage mode), output **ON**/OFF
  - Password (See Figure 3-6 for default settings)
    - Password Settings: Menu protection (Interface/Max-Min/Load/Test/Calibration/Power-up/Keypad @ local/Keypad@power-up), Save Display Change (Enable/**Disable**), Passwords (Unprotected/Main/Admin1/Admin2)

### 3.2.4.1 HOW TO MODIFY A PARAMETER

First access the parameter by accessing the proper menu as described above (PAR 3.2.4); Tables 3-3 through 3-16 list the menu parameters. To modify a parameter listed in a menu or submenu, proceed as follows:

1. Highlight the parameter using the  and  keys.
2. When the desired choice is highlighted, press  to modify the active setting. The choices are displayed with the active setting highlighted. In the case of numerals, the units digit is highlighted.
  - To change a numeric setting, press the number keys, then press **ENTER** to program the numbers entered. Use the **CLEAR key** to clear numbers entered and start over.
  - To change a main channel (voltage or current) or Protect value with the units digit highlighted, press the number keys, (from most significant to least significant digit) including the decimal point when needed, then press **ENTER** to apply the change or press the  or  key to abort the change.

- The **ADJUST** control can also be used to increment or decrement the highlighted digit. Pressing **ADJUST** while rotating adjusts the least significant digit. If the output is on (unit not in Standby) while changing main channel or Protect values, changes made using the **ADJUST** control are immediately applied to the output.
  - For alphanumeric characters, first use the  and  keys to highlight the desired character, then use the  or  keys or **ADJUST** control to scroll through numbers, letters and symbols. Then use the  and  keys to highlight the next character and repeat. Use the **CLEAR** key to clear the entire alphanumeric field and start over. As an alternative, use multiple presses of the keys for letters or symbols:  (space),  (+, -, /),  (ABC),  (DEF),  (GHI),  (JKL),  (MNO),  (PQRS),  (TUV),  (WXYZ),  (., :),  (+, -). Use the  key to highlight the next character.
3. Press  to apply the change and return to the menu (to change another parameter, repeat steps 1 and 2). To abort (return to the menu without applying the change), press .



NOTE: Press **HELP** key for more information, press **HELP** again to see multiple screens; press **CLEAR** key to exit the help screen.



### 3.2.4.2 PASSWORD SETUP.

Parameters that can be protected may be designated as Unprotected (no password required) or assigned one of three possible passwords: Main Unit, Admin 1 and Admin 2. The three passwords can be used to independently protect certain settings to prevent tampering or inadvertent reconfiguration of the BOP, yet allow access to qualified personnel. **These password levels apply only to local operation.** When in remote, only the main password is accessible, acting as a general password (see PAR B.173). The functions that can be password protected are Interface settings, Max/Min settings, Load type, Test, Calibration, Power-up Settings, and Keypad lockout at power-up (see Figure 3-6 for factory default password settings). In addition, it is possible to prevent changes made to the display settings from being saved for power up by setting Save Display Chg to Disable.



When the unit is operating in remote mode with Keypad @ local activated, a password is required before the unit can be returned to local operation. In addition, when a waveform is executing in local mode, depressing  to stop the waveform requires a password before the waveform is stopped.

To change any password you must enter the Admin 2 password to access the Password Menu. The unit is shipped with the Admin 2 password set to "KEPCO," the Main Unit password set to "DEFAULT," and the Admin 1 password is not assigned. To change the password or to protect one of the protected menus, proceed as follows:



1. Press  from the power-up screen to enter the General Setup menu. Highlight Password and press .
2. Enter the Admin 2 password (see PAR. 3.2.4.3 for details), then press  to verify. The Password Protection menu (see Figure 3-6) is now displayed.

3. To change a password, highlight the Main Unit, Admin 1 or Admin 2 password and press  to modify.
4. Press **CLEAR** to erase the previous password from memory.
5. Enter the new password (see PAR. 3.2.4.3) and press  to save. Up to eight characters are permitted for passwords.

NOTE: Do NOT use space characters for passwords

6. To protect or unprotect a menu highlight the password setting for the menu (Interface, Max-Min, Load, Test, Power-up, Keyboard @ Local, Keypad@power-up) and press  to modify. Highlight either the desired password (Main Unit, Admin 1 or Admin 2) or Unprotected and press  to save.



NOTE: To restore the password protection defaults shown in Figure 3-6, press ; this leaves the three individual passwords remain unchanged.

7. When complete, press  to save for power-up or  to apply the changes (without saving for power-up) and exit.

### 3.2.4.3 HOW TO ACCESS A PASSWORD PROTECTED MENU

An administrator can independently assign one of three passwords (Main Unit, Admin 1 or Admin 2) to eight functions. Under General Setup the Series/Parallel submenu is assigned the Admin 2 password; this cannot be changed.

When trying to modify a protected setting or access a protected menu, the message **PASSWORD IS REQUIRED** appears at the top, and the first character is highlighted. Proceed as follows:

1. Enter the first character of the password using the keypad or ADJUST control (see PAR. 3.2.4.1 for entry of alphanumeric characters). (To change the password, refer to PAR. 3.2.4.2.)
2. Press  to move to the next character and repeat step 1 for the next character of the password.
3. Repeat steps 1 and 2 until the correct password is displayed, then press  to verify. The protected setting or menu will now be accessible

NOTE: If the password is incorrect, the message **Password incorrect** is displayed at the bottom of the screen. Press **CLEAR** and proceed to step 1 above.

3042519-10

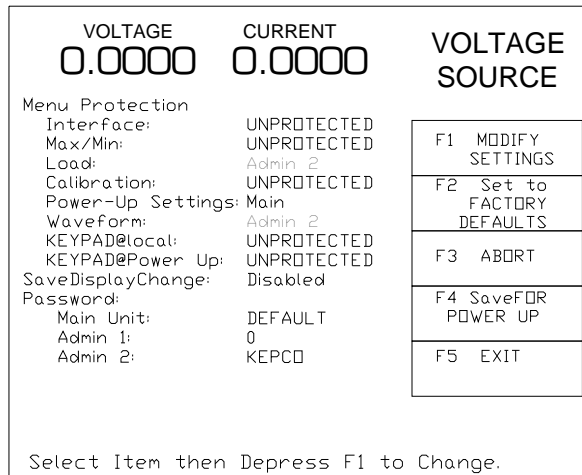

**FIGURE 3-6. PASSWORD PROTECTION MENU, FACTORY DEFAULTS**

### 3.2.5 DISPLAY SETTINGS (OPERATOR CONVENIENCE) MENU

From the power-up screen (Figure 3-4), pressing **F3** opens the Display Settings Menu (see Figure 3-7 and Table 3-3). The functions listed can be modified using the techniques described in PAR.3.2.4). This function is always available, whether in Local, Remote or Local/Lockout mode.

NOTE: If **F4** is not available when the Display Settings menu is open, these functions (see PAR. 3.2.5.1 to 3.3) can not be saved for power-up. To save for power-up it is first necessary to change SAVE DISPLAY CHG at the password setup from DISABLE (default) to ENABLE (see PAR. 3.2.4.2 and Figure 3-6). After saving the changes for power-up, SAVE DISPLAY CHG at the password setup can be set to DISABLE to prevent future changes if desired.

3042519-19

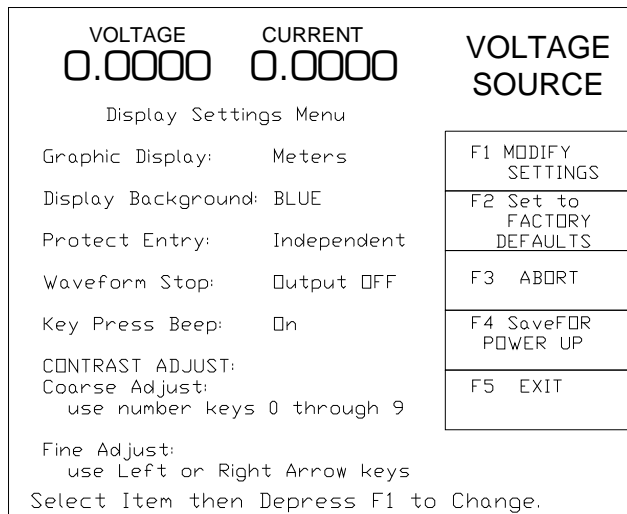





**FIGURE 3-7. DISPLAY SETTINGS MENU**











### 3.2.5.1 DISPLAYING METERS OR GRAPH (TIME LINE)

The top screen can be configured to either display graphical analog meters (Figure 3-4) showing a coarse representation of voltage and current in addition to the digital readout, or a graphical time line (Figure 3-5). The graphical time line is not an oscilloscope type display. Instead, it samples the output and refreshes the screen at a specified interval: 75, 30, 15, 7.5, 3.8, 1.5, 0.8, 0.3, or 0.15 Seconds. This can be useful when executing a waveform, although it is not a substitute for monitoring the output with an oscilloscope for precision. There is no correlation between voltage and current graphs. For the best graphical representation choose the graph time that is closest to, but greater than, the waveform time duration.

From the power-up screen, press , then highlight the Graphic Display setting and press . Highlight either Meters or one of the graph selections and press  to save. Then press  to save for power-up or  to exit.

### 3.2.5.2 ADJUSTING LCD CONTRAST AND BACKGROUND

To adjust the display contrast press  from the power-up screen (Figure 3-4), to enter the Display Settings menu. Use number keys 0 (darkest) through 9 (lightest) to adjust contrast. Use the  and  keys for fine adjustment of contrast.

To change the background, press  from the power-up screen, Highlight Display Background, press , highlight desired background color (see Table 3-3). Press  to save or  to abort. Then press  to save for power up or  to exit without saving for power up.

### 3.2.5.3 WAVEFORM STOP

Waveform Stop setup is described briefly in Table 3-3, and more fully in PAR 3.3.10.7.



### 3.2.5.4 ENABLING/DISABLING AUDIBLE BEEPS

From the power-up screen (Figure 3-4), press , then refer to Table 3-3 and modify the setting using the techniques described in PAR. 3.2.4). Even though audible beeps are set to off, the beeps will still sound upon power-up or detection of a power supply fault.

















## 3.3 LOCAL MODE OPERATION

Local operation of the BOP power supply can be accomplished from the front panel via the 27 key keypad, and the ADJUST knob. All indications are provided by the 4.7-inch color graphical display (LCD).

### 3.3.1 SETTING LOCAL MODE

When the power supply is turned on, it is automatically set to Local mode. After the unit is on, if the display shows **F1-LOCAL**, the unit has received a remote command and  must be pressed to unlock the keypad. However if the display shows **F1-LOCK** upon power up, the keypad has been locked by **KEYPAD @ power up** from the Power Up Settings menu (see Table 3-7). Pressing any key allows the user to enter a password before pressing ; if the password is correct, the keypad will be unlocked until the next remote command is issued. If the display shows **F1-LOCK REMOTE** after initial power up, the keypad has been locked by the SYST:KEYB DIS command and can only be unlocked by the SYST:KEYB ENAB command.

**TABLE 3-3. DISPLAY SETTINGS (OPERATOR CONVENIENCE) MENU**







SETTING	CHOICES ( <b>BOLD</b> = Factory Default)	FUNCTION
NOTE: To save any of the functions listed below for power-up it is necessary to first change SAVE DISPLAY CHG at the password setup (see PAR. 3.2.4.2 and Figure 3-6) from DISABLE to ENABLE.		
Graphic Display	<p><b>Meters</b></p> <p>75s 30s 15s 7.5s 3.8s 1.5s 0.8s 0.5s 0.3s 0.15s</p>	<p><b>Meters</b> - Output voltage and current are displayed on representations of analog meters.</p> <p><b>75s through 0.15s</b> - Displays a graph showing a sample of the output for the time indicated (see Figure 3-5). The complete time-line uses 240 points. E.g., selecting 2 Second Graph means that 2S/240 = 50ms sampling, i.e., every 50ms a snapshot of the output state is used to produce a single point.</p>
Display Background	<p><b>BLACK</b></p> <p>WHITE</p> <p>MonoBlack</p> <p>BLUE</p> <p>GREEN</p> <p>Lt.Green</p> <p>Lt.Blue</p>	<p><b>BLACK</b> - Sets the background to black and displays white characters plus color for voltage and current and special messages and warnings.</p> <p><b>WHITE</b> - Sets the background to white and displays black characters plus color for voltage, current, special messages and warnings.</p> <p><b>MonoBlack</b> - Sets background and characters to either white or black only.</p> <p><b>BLUE</b> - Sets the background to blue and displays black characters plus color for voltage, current, special messages and warnings.</p> <p><b>GREEN</b> - Sets the background to green and displays red characters plus color for voltage, current, special messages and warnings.</p> <p><b>Lt.Green</b> - Sets the background to light green and displays black characters plus color for voltage, current, special messages and warnings.</p> <p><b>Lt.Blue</b> - Sets the background to light blue and displays black characters plus color for voltage, current, special messages and warnings.</p>
Protect Entry	<p><b>Independent</b></p> <p>Bipolar</p>	<p><b>Independent</b> - Allows + and – protection limits to be set independently, from the front panel (see PAR. 3.3.3.1 for considerations when using remote mode).</p> <p><b>Bipolar</b> - Causes a single protection limit value (one for voltage, one for current) to apply to both ± limits. Only one value is displayed and edited from the front panel. (see PAR. 3.3.3.1.)</p>
Waveform Stop	<p><b>Output OFF</b></p> <p>User Option</p> <p> Stop Immediate</p> <p> Stop &amp; End Cycle</p> <p> Output OFF</p>	<p><b>Output OFF</b> - When waveform is stopped (either count complete or  pressed), output freezes at whatever level the waveform was at when  was pressed or count completed, then after a brief delay output is set to STANDBY (disabled).</p> <p><b>User Option</b> - Allows three choices during waveform execution:</p> <ol style="list-style-type: none"> <li>1. Press  to select <b>Stop Immediate</b> - When waveform is stopped ( pressed), output freezes at whatever level the waveform was at when  was pressed.</li> <li>2. Press  to select <b>Stop and End Cycle</b> - When waveform is stopped (either count complete or  pressed), waveform runs through full cycle. The output stops at the last generated value of the waveform (e.g., for a sinewave segment of 0° to 270°, 10V amplitude, 0V offset, when  is pressed the output will end up at -10V).</li> <li>3. Press  to select <b>Output OFF</b>. This is the same as Output OFF described above,</li> </ol>
Key Press Beep	<p><b>On</b></p> <p>Error Only</p> <p>Off</p>	<p><b>On</b> - provides an audible beep for each key press and for each error received.</p> <p><b>Error Only</b> - silences the beeps for each key press; errors will still cause beep.</p> <p><b>Off</b> - silences all beeps including key presses and errors except for power-up and unit faults.</p>
CONTRAST	---	Use number keys 0 through 9 for coarse adjust. Use  and  for fine adjust. Then press  to exit or  to save for power up (see PAR. 3.2.5.1).

### 3.3.1.1 KEYPAD LOCKOUT

To prevent the unit from entering local mode from the front panel once remote mode has been entered, refer to PAR. 3.2.4.2 and assign a password to “**Keyboard @ local.**” Then the unit will not permit local operation until the proper password has been entered (see PAR. 3.2.4.3). NOTE: The  key can still be used to adjust display contrast before entering the password.

If the  key legend is **F1-LOCK REMOTE**, the keypad has been locked by the remote command, SYST:KEYB DIS (see PAR. B.162). To unlock the keypad, either send SYST:KEYB ENAB or turn the unit off then on again.



### 3.3.1.2 LOCAL PASSWORD PROTECTION AT POWER-UP







It is possible to require a password before the front panel controls can function when the unit is powered up. From the power-up screen, press , highlight password, then . Enter Admin 2 password (see PAR. 3.2.4.3) and press  to verify. Under Menu Protection, highlight Keypad @ Pwr-up and press F1. Highlight one of three password settings and press  to save. Then press  to save for power-up (or  to exit without applying the changes). When the unit is next powered up, pressing any keypad key or rotating the **ADJUST** control requires entry of the password selected above before continuing. NOTE: The  key can still be used to adjust display contrast before entering the password.



### 3.3.2 SETTING VOLTAGE OR CURRENT MODE

The BOP uses two separate channels, one to set output voltage or current and one to set the corresponding protection limit. The main channel is determined by the **MODE** key (in local mode) which alternately selects either Voltage mode or Current mode or by SCPI command (in digital remote mode). The protection channel is determined automatically by the main channel selected. When Voltage mode is selected, the current protection channel is active, and when Current mode is selected, the Voltage protection channel is active. Table 3-4 defines the voltage and current parameters used in this manual.

### 3.3.3 PROGRAMMING VOLTAGE OR CURRENT AND ASSOCIATED PROTECT LIMITS







From the power-up screen the settable voltage/current parameters are displayed at the bottom of the LCD above the **HELP** message (see Figure 3-4). Use  or  to highlight the main or protect channel. (For BOP protect limits refer to PAR. 3.3.4.2 and for external limits see PAR. 3.3.4.3.)

1. To verify that the unit is configured for internal references press  from the power-up screen and verify that Reference Input and Protection Limit are set to Internal, and External Mode is set to Disable. If necessary to change a setting, use  or  to highlight the parameter, and press  to modify. Highlight the desired selection and press  to save, then press  to save for power-up or  to exit. If analog programming is desired, refer to PAR. 3.4.
2. Verify that the load has been configured properly to ensure that the unit behaves as expected when the output is off (see PAR. 3.3.7 for details).
3. Press **MODE** key to select the main channel (VOLTAGE or CURRENT); the associated PROTECT channel is automatically selected and displayed.
4. Set the output on or off as desired using the **STANDBY** key. The output is off (disabled) when the **STANDBY** indicator is lit, on (enabled) when not lit.

5. Use  or  to highlight the main channel. There are two ways to program the output in local mode (these methods can be used either when the output is disabled (**STANDBY** indicator lit) or enabled):



**CAUTION:** When the **ADJUST** control is rotated, the active parameter is immediately effective if the output is enabled (on = **STANDBY** indicator not lit). The voltage/current applied to the load changes as the **ADJUST** control is rotated.

- a. Use the **ADJUST** control to increase or decrease the main channel setting (e.g., voltage when the unit is in voltage mode). Start with the most significant digit of the desired value, then use  to highlight the next digit. For fine adjustment press the **ADJUST** control in while rotating the knob to modify the least significant digit.
- b. Enter the desired value on the keypad using the number keys. For example, to program the BOP to 75.8V, press the following keys in order  then press **ENTER**. For fine adjustment use  and  to modify the least significant digit. To correct the entry before activation press the **CLEAR** key to set the value to zero and start over. When the desired value is displayed, press **ENTER**. This causes the new value to appear at the output and be applied to the load if the output is enabled.



**TABLE 3-4. VOLTAGE AND CURRENT PARAMETER DEFINITIONS**

Term	Definition	To modify refer to PAR.	
		Local	Remote
+E <sub>Onom</sub> -E <sub>Onom</sub>	The nominal (rated) output voltage of the unit determined by model; e.g. for a BOP 36-56MG, ±E <sub>Onom</sub> is 36V.	N/A	N/A
+I <sub>Onom</sub> -I <sub>Onom</sub>	The nominal (rated) output current of the unit determined by model; e.g. for a BOP 36-56MG, ±I <sub>Onom</sub> is 56A.	N/A	N/A
+Voltage -Voltage	<b>Voltage mode only.</b> Positive (+) and negative (-) output voltage values established by keypad or remote command. Range (+): 0 to +Voltage max Range (-): 0 to -Voltage min		B.103
+Voltage max -Voltage min	<b>Voltage mode only.</b> Maximum (positive) and minimum (maximum negative) voltage that can be set. Value (+): 0 to +E <sub>Onom</sub> Value (-): 0 to -E <sub>Onom</sub>	3.3.4.1	B.105, B.106, B.107, B.109
+Current Protect -Current Protect	<b>Voltage mode only.</b> Defines maximum (+) current and Minimum (maximum negative) (-) that unit can source or sink. Range (+): +Current Protect min to +Current Protect max Range (-): -Current Protect max to -Current Protect min		B.37, B.38, B.43, B.41
+Current Protect Max -Current Protect Min	<b>Voltage mode only.</b> Maximum setting for +Current Protect and Minimum (maximum negative) setting for -Current Protect. Value (+): +Current Protect min to (1.01 x +Current max) Value (-): -Current Protect max to (1.01 x -Current min)	3.3.4.2	B.45, B.46, B.47, B.48
Minimum (box) +Current Protect Min -Current Protect Max	<b>Voltage mode only.</b> Minimum (positive) setting for +Current Protect and maximum (maximum negative) setting for -Current Protect. Values of ±Current Protect between +Current Protect Min and -Current Protect Max (near zero) are not allowed. This zone (also referred to as the <b>minimum (box)</b> is a model-dependent constant, approximate 0.2% of I <sub>Onom</sub> (see Figure 1-3).	N/A	N/A

**TABLE 3-4. VOLTAGE AND CURRENT PARAMETER DEFINITIONS (CONTINUED)**

Term	Definition	To modify refer to PAR.	
		Local	Remote
+Voltage Protect -Voltage Protect	<b>Current mode only.</b> Maximum positive (+) and minimum (maximum negative) (-) voltage that can appear at the output. Range (+): +Voltage Protect min to +Voltage Protect max Range (-): -Voltage Protect max to -Voltage Protect min		B.113, B.115, B.119, B.117
+Voltage Protect Max -Voltage Protect Min	<b>Current mode only.</b> Maximum (positive) setting for +Voltage Protect and Minimum (maximum negative) setting for -Voltage Protect. Value (+): +Voltage Protect min to (1.01 x +Voltage max) Value (-): -Voltage Protect max to (1.01 x -Voltage min)	3.3.4.2	B.121, B.122, B.125, B.123
Minimum (box) +Voltage Protect Min -Voltage Protect Max	<b>Current mode only.</b> Minimum (positive) setting for +Voltage Protect and maximum (maximum negative) setting for -Voltage Protect. Values of ±Voltage Protect between +Voltage Protect Min and -Voltage Protect Max (near zero) are not allowed. This zone (also referred to as the <i>minimum (box)</i> ) is a model-dependent constant, approximate 0.2% of $E_{Onom}$ (see Figure 1-3).	N/A	N/A
+Current -Current	<b>Current mode only.</b> Positive and negative output current established by keypad or remote command. Range (+): 0 to +Current max Range (-): 0 to -Current min		B.27
+Current max -Current min	<b>Current mode only.</b> Maximum (positive) and minimum (maximum negative) current that can be set. Value (+): 0 to $+I_{Onom}$ Value (-): 0 to $-I_{Onom}$	3.3.4.1	B.29, B.30, B.36, B.36

NOTE: The value entered for the main channel and the protect channel is automatically prevented from exceeding the preset maximum software limit (see PAR. 3.3.4).

- To program the corresponding Protect channel, press  or  as necessary to highlight the Protect channel. Then set the value using either of the two methods described above. If the Protect Entry setting (see PAR. 3.3.3.1) is set to Independent, separate entries for the positive and negative protect channel are possible. Otherwise the value entered is applied to both positive and negative protect channels.

### 3.3.3.1 SELECTING BIPOLAR/INDEPENDENT PROTECTION LIMITS

The BOP can be configured to allow the protection limits to be displayed and changed from the front panel as either a single value that applies to both protection channels or as individual settings for positive and negative protection limits. Selecting Independent protection limits means that the positive and negative limits are displayed (and can be modified) independently. Bipolar means that for each protection limit (voltage or current) a single value applies to both the positive and negative limits; only one value is displayed and can be edited for both ± protection limits.

If the MAX/MIN Protect Settings are not symmetrical when Protect Entry is set to Bipolar, the protect setting can be adjusted from 0 to the higher protection limit from the front panel; the unit automatically limits the lower protection limit to the MAX/MIN settings value.

For example, if the unit is in Current mode with +V Protect Max set to 10, -V Protect Max set to 5 and Protect Entry set to Bipolar, setting VPROTECT to 4 from the front panel sets both the

positive and negative protection levels to 4. Adjusting VPROTECT to 6 sets the positive protection level to 6 but the negative protection level is automatically limited to 5 by -V Protect Max with no errors or warnings generated.

Press **F3** from the power-up screen to enter the Display Settings menu (Figure 3-7), then highlight Protect Entry and press **F1** to change it. Highlight Bipolar or Independent, then **F4** to save, or **F5** to abort. When complete, press **F4** to save for power-up, **F3** to abort, or **F5** to apply the changes (without saving for power-up) and exit.

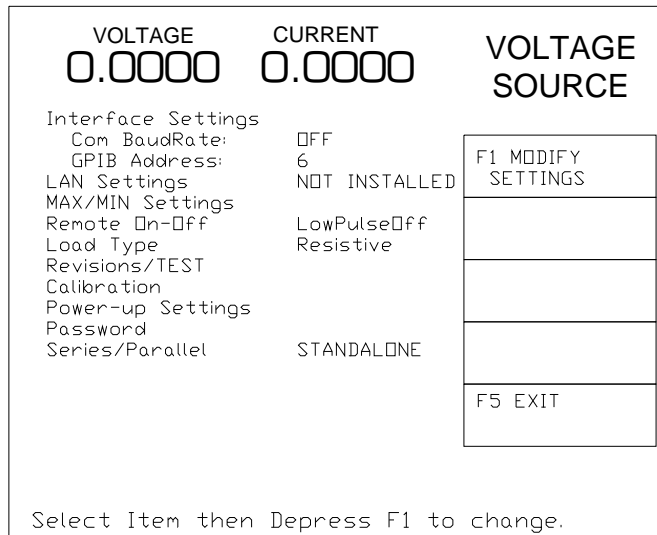

3042519-4

**FIGURE 3-8. GENERAL SETUP MENU**

Selection of Bipolar does not immediately change the protect limit values; it changes how the protect settings are displayed and set from the power-up screen. So if *maximum/minimum* protection limits were set to different values, (e.g, for BOP 36-56MG, current mode, no load, +V Protect Max = 25V and -V Protect Min = 7V) when Bipolar is selected, the previous protection values (+25, -7) will remain in place until a new value is entered in the Voltage Protection field. When a new Voltage Protect setting, e.g., 22V, is entered with Bipolar mode selected, +Voltage Protect is set to +22V and -Voltage Protect is set to -22V.

**NOTE:** The use of remote programming (via LAN or GPIB) automatically asserts Independent protection limits. Once the unit is returned to local mode, the unit is automatically returned to Bipolar mode.

### 3.3.3.2 UNDERSTANDING VOLTAGE AND CURRENT PROTECT LIMITS

These values are the references for the complementary channels: voltage in current mode and current in voltage mode. The range for these values is between a minimum (box) value (see Figure 1-3) and 1% above the rated nominal value (see PAR. 3.3.4.2). If the unit is in voltage mode, it will enter current protect mode when the load demands more current and energy than permitted by the  $\pm$ current protect settings. Similarly, if the unit is in current mode, it will enter voltage protect mode if the load demands more voltage and energy than permitted by the  $\pm$ voltage protect settings. When the protect settings are exceeded, the protection channel limits the output, a VPROTECT, CPROTECT or PROTECT message is displayed at the upper right of the LCD, and the power supply continues operation (PROTECT may be seen only when external limits

are in use). When VPROTECT is displayed, bit 12 of the questionable status register is set. When CPROTECT is displayed, bit 13 of the of the questionable status register is set. When PROTECT is displayed, both bits 12 and 13 of the questionable status register are set. (see para 3.6.7.3).

### 3.3.3.3 HIDDEN VOLTAGE AND CURRENT PROTECT LIMITS

The BOP employs two back-up channels which function as safety backups if a main channel fails. The backup channel limits are fixed and not user accessible. These limits are set to 5% over the nominal (rated) values for voltage or current. If the software limits for a main channel is changed (PAR. 3.3.4.1), the corresponding protect channel limit is automatically changed to be 5% of the nominal (rated) value above the user-programmed software limit.

### 3.3.4 CHANGING MAXIMUM OR MINIMUM SOFTWARE-CONTROLLED LIMITS

The maximum or minimum allowable voltage and current settings of the unit can be reduced from the nominal using the Max/Min Settings menu (Table 3-5). which lists the system’s software-controlled voltage and current limits (+Voltage Max, –Voltage Min, +Current Max, –Current Min) as well as the corresponding protection limits organized by operating mode. The default values of the system limits are established by the Model: the nominal (rated) values for voltage and current and 1.01 x the nominal (rated) values for protection. The default values can be reduced by modifying the highlighted parameter. The unit will not accept local or remote commands that exceed the system limits. The system limits are always in effect, even when the unit is controlled by an external reference. **If system limits are changed, the protection limits must be changed to correspond to the new system limits.** As an example, changing +Voltage Max and –Voltage Min of a BOP 36-56MG to ±3V, respectively, causes the unit to behave as if it was a BOP 3-56MG. In this case it is important to change the +V Protect Max and –V Protect Min limits (e.g., to ±3.3V, respectively) so that the load is protected when operating in Current Mode. System limits are absolute values (do not use minus sign for negative limits).

The internal parameters +Current Protect Min and –Current Protect Max are displayed to completely define the permissible window when operating in Voltage mode. Similarly, +Voltage Protect Min, and –Voltage Protect Max are displayed to completely define the permissible window for voltage when operating in Current mode.

**TABLE 3-5. MAX/MIN SETTINGS MENU**

SETTING	CHOICES ( <b>BOLD</b> = Factory Default)	FUNCTION
<b>VOLTAGE MODE</b>		
+Voltage Max	(value) <b>+Eomax</b>	Defines the maximum voltage level that can be set in voltage mode. Default = Rated +Output voltage (e.g., for BOP 36-56MG, Eomax = 36). To modify, see PAR. 3.3.4.1.
–Voltage Min	(value) <b>–Eomax</b>	Defines the minimum (maximum negative) voltage level that can be set in voltage mode. Default = Rated –Output voltage (e.g., for BOP 36-56MG, Eomax = 36). To modify, see PAR. 3.3.4.1.
+C Protect Max	(value) model specific up to <b>Iomax + 1% of Iomax</b>	Defines the maximum value for +Current Protect. To modify refer to 3.3.4.1.
+C Protect Min	( <i>internal value</i> ) <i>Not Adjustable</i>	Defines the minimum value that +Current Protect can be set to. This is a model-dependent constant, approximately 0.2% of I <sub>Onom</sub> and is not adjustable from the front panel.
–C Protect Min	(value) model specific up to <b>Iomax + 1% of Iomax</b>	Defines the minimum (maximum negative) value for –Current Protect. To modify refer to 3.3.4.1.

**TABLE 3-5. MAX/MIN SETTINGS MENU (CONTINUED)**

SETTING	CHOICES ( <b>BOLD</b> = Factory Default)	FUNCTION
-C Protect Max	<i>(internal value) Not Adjustable</i>	Defines the maximum (minimum negative) value that -Current Protect can be set to. This is a model-dependent constant, approximately 0.2% of $I_{Onom}$ and is not adjustable from the front panel.
<b>CURRENT MODE</b>		
+Current Max	(value) <b>+Iomax</b>	Defines the maximum current level that can be set in current mode. Default = Rated +Output current (e.g., for BOP 36-56MG, Iomax = 56). To modify, see PAR. 3.3.4.1.
-Current Min	(value) <b>-Iomax</b>	Defines the minimum (maximum negative) current level that can be set in current mode. Default = Rated -Output current (e.g., for BOP 36-56MG, Iomax = 56). To modify, see PAR. 3.3.4.1.
+V Protect Max	(value) <b>Eomax + 1% of Eomax</b>	Defines the maximum value that +Voltage Protect can be set to. To modify refer to 3.3.4.1.
+V Protect Min	<i>(internal value) Not Adjustable</i>	Defines the minimum value that +Voltage Protect can be set to. This is a model-dependent constant, approximately 0.2% of $E_{Onom}$ and is not adjustable from the front panel.
-V Protect Min	(value) <b>Eomax + 1% of Eomax</b>	Defines the minimum (maximum negative) value for -Voltage Protect. To modify refer to 3.3.4.1.
-V Protect Max	<i>(internal value) Not Adjustable</i>	Defines the maximum (minimum negative) value that -Voltage Protect can be set to. This is a model-dependent constant, approximately 0.2% of $I_{Onom}$ and is not adjustable from the front panel.
NOTE: To restore all Max/Min settings defaults, press <b>F5</b> from the power-up screen, highlight Max/Min settings, press <b>F1</b> , then press <b>F2</b> to restore defaults shown above in <b>BOLD</b> . Press <b>F4</b> to save for power-up or <b>F5</b> to apply the changes (without saving for power-up) and exit.		

### 3.3.4.1 CHANGING MAXIMUM ACCEPTED VOLTAGE OR CURRENT (MAIN CHANNEL SOFTWARE LIMITS)

The software limits for the main channels (+Voltage Max, -Voltage Min, +Current Max and -Current Min) are the maximum (positive) and minimum (Maximum negative) values allowable for voltage and current. The default software limits are determined by the model: the nominal (rated) values for voltage and current (e.g., 36V and 56A for the BOP 36-56MG). These four values can be adjusted independently. For example, a BOP 36-56MG, capable of delivering  $\pm 36V$  in voltage mode can be configured to allow voltage to be adjusted only from -1V to +15V by setting -Voltage Min to -1 and +Voltage Max to +15. Similarly, a BOP 36-56MG, capable of delivering  $\pm 56A$  in current mode can be configured to allow current to be adjusted from -0.5A to +10A by setting -Current Min to -0.5 and +Voltage Max to +10. Adjustment range is between 0 and  $E_{Onom}$  for voltage and 0 and  $I_{Onom}$  for current. Note that these software limits are not the same as the Protect Limits described in PAR. 3.3.4.2.

The main channel software limit values can be lowered (closer to zero) by the user, e.g., to prevent inadvertent damage to a specific circuit under test. When the maximum/minimum values are lowered, the unit will not accept values that exceed the new software limits. If the user attempts to enter a value that exceeds the software limit, the unit will continue to function. In local mode the **Exceeding Maximum Allowed Value** message is displayed, and the output will be clamped to the main channel software limit (maximum/minimum) value. In remote mode the command is considered invalid and is disregarded: a 120 error is produced and the message **Voltage Out of Range** or **Current Out of Range** is displayed on the front panel.



The main channel software limits are always in effect, even when the unit is controlled by an external reference. **If main channel software limits are changed from the default, the protection limits must be changed to correspond to the new software limits (see PAR. 3.3.4.2).** As an example, changing +Voltage Max and –Voltage Min of a BOP 36-56MG to ±3V, respectively, causes the unit to behave as if it was a BOP 3-56MG. In this case it is important to change the +V Protect Max and –V Protect Min limits (e.g., to ±3.3V, respectively) so that the load is protected when operating in Current Mode.

1. Press **F5** from the power-up screen to enter the General Setup menu, then highlight Max/Min Settings.
2. Press **F1** to enter the Max/Min Settings submenu (Figure 3-9 and Table 3-5). (If a Password is required, see PAR. 3.2.4.3 for instructions.)
3. Highlight the voltage or current max/min value and press **F1** to change it. Software limits are absolute values (do not use minus sign for negative limits). Use number keys to change the setting, then **F4** to save.
4. When complete, press **F4** to save for power-up, **F3** to abort, or **F5** to apply the changes (without saving for power-up) and exit.
5. Upon return to the power-up screen, the main channel (voltage or current) is compared against the main channel limits in effect. If the main channel exceeds the limit, it is set to zero.

NOTE:  
VALUES SHOWN ARE  
TYPICAL FOR  
BOP 10–75MG.

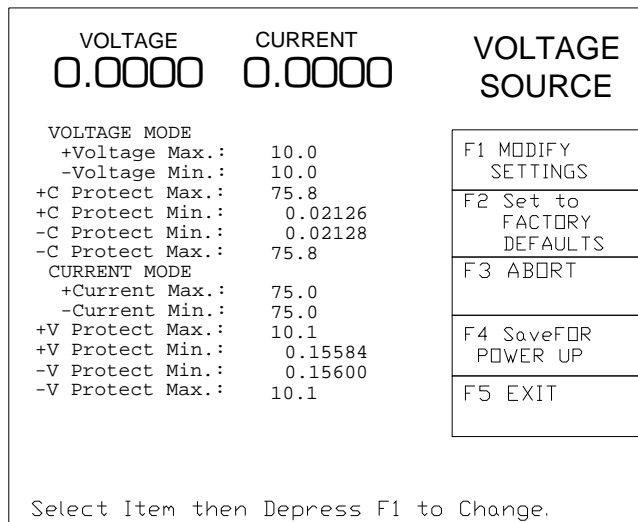

**FIGURE 3-9. MAX/MIN SETTINGS MENU**

### 3.3.4.2 CHANGING MAXIMUM/MINIMUM PROTECTION SOFTWARE-CONTROLLED LIMITS

The  $\pm$  protection limits are software limits that establish the maximum and minimum (maximum negative) allowable levels of output voltage in current mode and current in voltage mode. The default protection limits are 1% above  $E_{Omax}$  or 1% above  $I_{Omax}$ .

The protect channel limits are +V (voltage) Protect max, -V Protect min, +C (current) Protect Max and -C Protect min (see Table 3-4); these prevent the unit from delivering voltage or current that exceed these settings. In voltage mode the current protect channel is clamped to the limit value; in current mode the voltage protect channel is clamped to the limit value. Adjustment range is between a minimum (box) value (see Figure 1-3) and 1% above the nominal (rated) value.



**CAUTION:** When working with active loads, always adjust the BOP protection limits to be above the maximum values of voltage or current expected from the load. For example, when the BOP is operating in voltage mode sinking energy from a constant current type load, set the current protection limits of the BOP above the maximum current expected from the load.

1. Press **F5** from the power-up screen to enter the General Setup menu (Figure 3-8), then highlight Max/Min Settings and press **F1** to view. (If a Password is required, see PAR. 3.2.4.3 for instructions.)
2. Highlight the  $\pm C$  Protect or  $\pm V$  Protect Max or Min value and press **F1** to change it. Software limits are absolute values (do not use minus sign for negative limits). Use number keys to change the setting. Press **F4** to save, or **F5** to abort.
3. When complete, press **F4** to save for power-up, or **F3** to abort, or **F5** to apply the changes (without saving for power-up) and exit.
4. Upon return to the power-up screen, the new protection limit (voltage or current) is compared against the protection limits in effect. If the new protection limit setting is below the existing setting for the protection limit, the protection channel (voltage or current) is set to zero.

### 3.3.4.3 EXTERNAL LIMITS

These limits are external analog signals which are converted within the BOP to digital signals that program the protection channels only: current protect in voltage mode and voltage protect in current mode. The range of each analog input signal is +1V to +10V, corresponding to a range for clamping the output between minimum, 10% of nominal (positive and negative), to +max/-min of nominal rating. Refer to PAR. 3.4.5 for details on implementing external limits.

Table 3-4 explains the effect that these limits have in both voltage and current mode, and references the corresponding paragraph for changing the parameter in either local or remote mode.

### 3.3.5 ENABLING/DISABLING DC OUTPUT POWER

The BOP output can be disabled (OFF) or enabled (ON) by toggling the **STANDBY** key in local mode or sending the SCPI OUTPut ON or OUTPut OFF command (see PAR. B.21) via the selected digital remote control bus (see PAR. 3.5). The behavior of the unit when disabled depends on the Load Type setting (see PAR. 3.3.7 and Table 3-6 for details).

### 3.3.6 USING THE TRIGGER PORT TO CUSTOMIZE OUTPUT ON/OFF OPERATION

The Trigger Port, pin 2 (see Table 2-3) can be used to set the output on or off via a single remote signal. The Trigger port can be configured either locally, using the front panel, or remotely, using the OUTP CONT command. (see PAR. B.23).

From the front panel press **F5** from the power-up screen to enter the General Setup menu (Figure 3-8), then highlight Load Type and press **F1** to modify. (If a Password is required, see PAR. 3.2.4.3 for instructions.) Press down or up arrow key to highlight the Remote On-Off option, then press **F1** to open the Output Configuration screen and show choices. Highlight Disabled, High Is Off, Low Is Off, High Is On, Low Is On, or LowPulseOff (see Table 2-3 for details), and press **F4** to save or **F3** to abort. Then press **F4** to save for power-up, or **F3** to apply the changes (without saving for power-up) and exit. To restore factory default (LowPulseOff), press **F2** from the Output Configuration screen, then press **F4** to save for power-up or **F5** to exit.

### 3.3.7 DETERMINING HOW THE UNIT RESPONDS WHEN OUTPUT IS OFF (LOAD TYPE)

The BOP supports three Load Type selections (see Table 3-6) which determine how the power supply responds when the output is off: ACTIVE, RESISTIVE and BATTERY. (Load type CUSTOM (not normally active) permits customized settings to be implemented; for details contact consult factory.) These selections are designed to provide proper operation with different load types. It is important to note that the Load Type selection does not affect the settings of the power supply for ON state; it only affects the main internal reference level and the protection levels during the OFF state.

**TABLE 3-6. POWER SUPPLY BEHAVIOR WHEN OUTPUT IS SET TO OFF**

LOAD TYPE SETTING	If unit was in Voltage Mode when output OFF command issued.	If unit was in Current Mode when output OFF command issued.
ACTIVE	<ul style="list-style-type: none"> <li>Unit remains in voltage mode.</li> <li>Voltage set to zero.</li> <li>Both ± Current Protect set to maximum.</li> <li>Both ± Voltage Limit remain at maximum.</li> </ul>	<ul style="list-style-type: none"> <li>Unit set to voltage mode.</li> <li>Voltage set to zero.</li> <li>Both ± Current Protect remain at maximum.</li> <li>Both ± Voltage Limit set to maximum.</li> </ul>
RESISTIVE	<ul style="list-style-type: none"> <li>Unit remains in voltage mode.</li> <li>Voltage set to zero.</li> <li>Both ± Current Protect set to minimum box values.</li> <li>Both ± Voltage Limit. remain at maximum.</li> </ul>	<ul style="list-style-type: none"> <li>Unit remains in current mode.</li> <li>Current set to zero.</li> <li>Both ± Voltage Protect set to minimum box values.</li> <li>Both ± Current Limit remain at maximum.</li> </ul>
BATTERY	<ul style="list-style-type: none"> <li>Unit set to current mode.</li> <li>Current set to zero.</li> <li>Both ± Voltage Protect. remain at maximum.</li> <li>Both ± Current Limit set to maximum.</li> </ul>	<ul style="list-style-type: none"> <li>Unit remains in current mode,</li> <li>Current set to zero.</li> <li>Both ± Voltage Protect set to maximum.</li> <li>Both ± Current Limit remain at maximum.</li> </ul>



**WARNING**

For inductive loads, and especially superconducting magnet type loads, the inherent offset of the BOP in the OFF state may generate significant current in the circuit. Two properly rated external switches must be installed for safety: one in series between the power supply and the magnet, and the other in parallel with the magnet. Once the BOP front panel display reads 0V, 0A, close the parallel switch, then open the series switch before removing or installing connections between BOP and load. To restore normal operation, first close the series switch, then open the parallel switch.

**ACTIVE.** Active mode (default setting) is necessary for the power supply to function properly and safely with inductive loads and constant-current-type active electronic loads. Active mode can also be used with resistive loads. Table 3-6 indicates how the power supply responds to a command to go from Output ON to OFF. When the output is disabled, the unit is set to voltage mode, voltage is set to zero and both current protect and voltage limit are set to maximum. When the unit is enabled, the pre-existing settings for voltage, current protect and voltage limit are restored.



**WARNING**

For both inductive loads and constant-current-type active electronic loads when the BOP output is set to OFF, a path is provided for absorbing either the energy accumulated in the reactance of the load during the ON state, or energy delivered by an electronic load. This prevents damage to the load and power supply as well as providing safety for the user. However, In addition to the built-in safety features, constant-current-type active electronic loads must be adjusted to zero and the BOP front panel LCD must read 0V, minimum current, before handling the power supply-to-load connections.

**RESISTIVE.** This mode, as the name suggests, is useful for resistive loads. Table 3-6 indicates how the power supply responds to a command to go from Output ON to OFF.



Accessing the BOP after the output is disabled in BATTERY mode is hazardous because (1) high current arcing is possible and (2) either the external battery voltage, or the voltage ( $\pm$ Voltage Protection max) on the BOP output terminals may be dangerous. Therefore, for battery and constant-voltage-type active electronic loads it is recommended that two properly rated external switches be installed for safety: one in series with the battery, and one across the BOP output. After the unit is set to OFF, first open the switch in series with the battery, then close the switch across the BOP output to ensure safety before handling BOP connections. When connecting the battery, the switch across the output should be opened after the connections are complete and then the switch in series with the battery should be closed. If the constant-voltage-type active electronic load is adjusted to zero before handling the power supply-to-load connections, only the switch across the BOP output is required.

**BATTERY.** This mode is necessary for the power supply to function properly and safely with either battery or constant-voltage-type active electronic loads. This mode prevents the battery from discharging during the OFF state. When the output is disabled (set to OFF), the BOP will go to current mode, current will be set to the calibrated zero value, with voltage protect and current limit set to maximum. In this way the battery will not be discharged while the output is OFF. However, even if properly calibrated, the zero current has a tolerance of  $\pm 0.01\%$  of nominal rated current. Therefore the battery will be very slowly charged or discharged by this non-zero current value, depending on its polarity. For constant-voltage-type active electronic loads this mode stops energy flow during the OFF state. Table 3-6 indicates how the power supply responds to a command to go from Output ON to OFF.



**CAUTION:** When working with battery mode, if the output is set to ON by \*RST (see PAR. 3.5.3.3) and the battery is charged above 0.01V, the unit will sink 105% of  $I_{Omax}$ .

To configure, press **F5** from the power-up screen, then highlight Load Type and press **F1** to modify. (If a Password is required, see PAR. 3.2.4.3 for instructions.) press **F1** to show choices. Highlight Active, Resistive or Battery (see explanations and associated WARNINGS above) and press **F4** to save or **F3** to abort. Then press **F4** to save for power-up, **F3** to abort, or **F5** to apply the changes (without saving for power-up) and exit. After configuring, the new setting will be effective when the power supply goes from output on to output off.

To restore factory default (Active), press **F5** from the power-up screen, highlight Load Type, press **F1**, then press **F2** to restore default. Press **F4** to save for power-up or **F5** to exit.

### **3.3.7.1 BATTERY CHARGING/DISCHARGING USING THE BOP**

The BOP can charge/discharge batteries using either voltage mode or current mode. The recommended configuration is to use voltage mode with remote sense connections.

#### **3.3.7.1.1 BATTERY OPERATIONS USING VOLTAGE MODE**

Using voltage mode with remote sensing connections provides more accurate voltage control of the battery, avoiding the effects of both parasitic voltage drops on the connection wiring and the battery's internal resistance.

The BOP output voltage is set to the desired battery voltage and current limit is set to the required charging current value. The BOP will go into current limit, charging the battery with a constant current. As the battery's voltage nears the BOP voltage setpoint, the BOP will switch to voltage mode when the battery voltage reaches the "capture" range of the BOP voltage loop.

The voltage loop has a resolution of 14 bits (either local or digital control) versus 12-bit resolution for the voltage-limit loop. Consequently, the voltage loop accuracy (0.03% of rated output) is ten times better than voltage-limit loop accuracy.

The charging process continues as long as the voltage remains within the "capture" range of the voltage mode. Charging current decreases gradually towards the battery's leakage value. This configuration eliminates the dithering (alternating between current and voltage limit mode) induced by the battery's internal resistance. The only drawback to using voltage mode is that the charging current limit resolution/ accuracy is 12-bit/ 0.5%, versus 14-bit/ 0.1% for current mode.

A similar process will take place when discharging the battery. By setting the BOP voltage to a lower level than the battery's voltage value, the battery discharge current will be established by the negative current limit setpoint. The discharging value can be different than for charging by using independent limits to set different values for positive and negative current limit.

#### **3.3.7.1.2 BATTERY OPERATIONS USING CURRENT MODE**

The following description explains the drawbacks of using current mode for battery operations. In voltage mode the voltage feedback comes from the remote sense terminals (OUT\_S, COM\_S). However In current mode the voltage limit feedback comes from the local output monitoring terminals (OUT\_MON & COM\_MON). This protects the load against excessive voltage if a sensing connection is lost while in current mode.

The result is that if current mode is used to charge a battery (with or without local sensing), the charging process will stop (putting the BOP into voltage limit mode) at a voltage lower than the voltage limit set value. This is due to a) the parasitic voltage drop on the connecting wiring and b) the internal battery's resistance. The BOP, now in voltage-limit mode, senses that battery voltage is lower than the voltage-limit set value and switches back to current mode. From this point, the BOP will change between current mode and voltage-limit mode (dither). The dithering rate will depend on the battery's internal impedance, the charging set current, the parasitic connection's resistance and the time it takes the BOP to switch between modes. In some cases, for a parasitic voltage drop equal to, or less than, the accuracy of the voltage limit loop (0.3% of rated

output), the dithering will stop. While dithering between current mode and voltage limit mode, the front panel meter will show an approximate average output voltage which will be higher than the voltage limit set value.

Discharging the battery using current mode operation must be carefully monitored. If the voltage limit is unchanged and the current is set to a negative value, the battery will discharge at the BOP current setpoint value. If the process is not monitored and stopped, the battery will be completely depleted. The BOP will even try to reverse-charge the battery to the negative voltage limit value. Therefore, if current mode is chosen, it is recommended that independent limits be used, and the negative voltage limit be set to minimum (0.2% of rated output voltage).

If the positive voltage-limit is set lower than the battery's voltage, then more than one loop will try to control the output. Consequently, the battery will discharge at a much higher current than the BOP current setpoint. As previously described, if not monitored and the process stopped, the discharge will completely deplete the battery.

If current mode is needed, Kepco can modify the unit to establish the voltage limit feedback loop to use the Sense terminals, rather than the Monitor terminals. The modified unit behaves similar to that described for voltage mode except that voltage accuracy is 12-bit/ 0.3%, versus 14-bit/ 0.1% for voltage mode. Contact Kepco Sales for further details.

### 3.3.8 CHANGING THE DEFAULT POWER UP SETTINGS

When the BOP is shipped, the default settings listed in Table 3-7 are programmed to be in effect each time the unit is turned on, however these defaults may be changed.

Table 3-8 illustrates the relationship between Mode of Operation, Main Channel Reference, Main Setting, Protection Type and Levels settings. To change the default settings refer to the applicable paragraph(s) specified in Table 3-7 as needed. then from the power-up screen press **F5**. Highlight Power-up Settings and press **F1**. (If a Password is required, see PAR. 3.2.4.3 for instructions.) Highlight the parameter and press **F1** to modify. Use **↑** **↓** or the **ADJUST** control to highlight a selection, then press **F4** to apply. To change a value use the number keys to enter new setting, then **F4** to apply. When all power-up settings have been configured, press **F4** to save for power up or **F5** to exit and abort the change.

To restore the factory default power-up settings listed in Table 3-7, from the power-up screen press **F5**. Highlight Power-up Settings and press **F1**. Then press **F2** to restore the defaults. Then press **F4** to save for power up or **F5** to exit and abort the change. Note that GPIB address and Baud Rate are NOT changed when **F2** is used to restore factory defaults.

These settings can be directly applied to a load upon power-up. Many other configurable settings can be saved for power up using the **F4** key after modifying the setting.

**TABLE 3-7. POWER UP SETTINGS MENU**

PARAMETER	CHOICES ( <b>BOLD</b> = Factory Default)	FUNCTION
NOTE: DEFAULT values for empty cells are the settings of the unit at the time the save/recall menu is entered.		
Mode of Operation	<b>Voltage</b> Current External	<b>Voltage</b> - Selects voltage mode. Voltage value determined by SETTING. <b>Current</b> - Selects current mode. Current value determined by SETTING. <b>External</b> - Used for customized configuration where EXT VM/CM signal at pin 2 of I/O port controls mode; consult factory for details.
Main Channel Reference	<b>Internal</b>  External  ExtRefLevel	<b>Internal:</b> Any external reference applied to the Analog I/O port pin 11 is ignored and the internal reference is established by Main Setting field. <b>External:</b> The internal reference is ignored, and the external reference applied to the Analog I/O port pin 11 is used (see PAR. 3.4.4.1). <b>ExtRefLevel:</b> Allows the gain of the BOP to be established by the maximum output voltage or current introduced by the Main Setting field. (see PAR. 3.4.4.2).
Main Setting	<b>0.0000</b> nn.nnn or nnn.nnn (model and parameter dependent)	Sets the active channel setting. E.g., if Voltage mode is selected, nnn.nnn is voltage setting, if Current mode is selected, nn.nnn is current setting. If External mode is selected, Main Setting is not available. (This value is visible only if Main Channel Reference is set to Internal or ExtRefLevel and the Remote On-Off (which controls shutdown pin 2 of the Trigger port) is not set to Disabled or LowPulseOff) (see PAR. 3.3.6 to view or modify Remote On-Off)
Protection Type	<b>Internal</b>  External  Lesser Limit	<b>Internal</b> - Allows limits to be controlled by POSITIVE and NEGATIVE values. <b>External:</b> Allows limits to be controlled by analog signals applied to the analog port (see PAR. 3.4.5). <b>Lesser Limit:</b> Allows protect limit to be automatically selected from either 1) the external analog voltage applied to the Analog I/O port or 2) the value set in the Voltage Protect and Current Protect fields. Whichever limit has a lower absolute value (closest to zero) has effect (see PAR. 3.4.5).
Voltage Level	nn.nnn or nnn.nnn	This is the ± value for Voltage protect when the unit operates in Current mode. If External mode is selected, this field is not accessible. To save nonsymmetrical protect values for power up, modify Max/Min settings as needed and press <b>F4</b> to save for power up.
Current Level	nn.nnn or nnn.nnn	This is the ± value for Current protect when the unit operates in Voltage mode. If External mode is selected, this field is not accessible. To save nonsymmetrical protect values for power up, modify Max/Min settings as needed and press <b>F4</b> to save for power up.
Output	<b>OFF</b>  ON	<b>OFF</b> - Output disabled. The behavior of the unit when output is disabled depends on the LOAD TYPE setting (see PAR.3.3.7). <b>ON</b> - Output enabled.





**TABLE 3-8. EXAMPLES SHOWING HOW POWER-UP SETTINGS FUNCTION**



Mode of Operation	Main Channel		Protection		Power-up condition (output set to ON) (All referenced pins located on Analog I/O Port see PAR. 3.4 and Figure 2-1)
	Reference	Setting	Type	Levels	
Voltage	Internal	5.0000	Internal	Voltage: 10 Current: 25	Unit powers up in voltage mode, +5V, $\pm$ current protection set to 25A. Pressing <b>MODE</b> changes mode to current, puts unit in standby: output to 0A, $\pm$ voltage protection to power-up setting of 10V, output off and STANDBY indicator on.
Current	Internal	-8.0000	Internal	Voltage: 10 Current: 25	Unit powers up in current mode, -8A, $\pm$ voltage protection set to 10V. Pressing <b>MODE</b> changes mode to voltage, puts unit in standby: output to 0V, current protection to power-up setting of 25A, output off and STANDBY indicator on.
Voltage	External or ExtRefLevel	N/A	Internal	Voltage: 10 Current: 25	Unit powers up in voltage mode, output voltage determined by Analog port, pin 11 (see PAR. 3.4.4.1 for External, PAR. 3.4.4.2 for ExtRefLevel), $\pm$ current protection set to 25A. Pressing <b>MODE</b> changes mode to current, puts unit in standby, $\pm$ voltage protection to power-up setting of 10V. When output is on (STANDBY indicator off), output current determined by pin 11.
Current	External or ExtRefLevel	N/A	Internal	Voltage: 10 Current: 25	Unit powers up in current mode, output current determined by Analog port, pin 11 (see PAR. 3.4.4.1 for External, PAR. 3.4.4.2 for ExtRefLevel), $\pm$ voltage protection set to 10V. Pressing <b>MODE</b> changes mode to voltage and puts unit in standby, $\pm$ current protection to power-up setting of 25A. When output is on (STANDBY indicator off), output voltage determined by pin 11.
Voltage	Internal	3.0000	External or Lesser Limit	N/A	Unit powers up in voltage mode, 3V, $\pm$ current protection determined by pins 5 and 13 (see PAR. 3.4.5 for External, PAR. 3.4.5.1 for Lesser Limit). Pressing <b>MODE</b> changes mode to current, puts unit in standby. When output is on, (STANDBY indicator off), $\pm$ voltage protection determined by, pins 6 and 14.
Current	Internal	7.000	External or Lesser Limit	N/A	Unit powers up in Current mode, 7A, $\pm$ voltage protection determined by pins 6 and 14 (see PAR. 3.4.5 for External, PAR. 3.4.5.1 for Lesser Limit). Pressing <b>MODE</b> changes mode to voltage, puts unit in standby. When output is on, (STANDBY indicator off), output voltage is 0V, $\pm$ current protection determined by, pins 5 and 13.

**3.3.9 STORING/RECALLING POWER SUPPLY OUTPUT SETTINGS**

The power supply settings (mode, main channel reference type and setting, protection limit type and setting and output status) can be stored in one of 99 memory locations for later recall. This feature is accessible from the front panel by pressing  from the power-up screen to view the Saved Settings screen (Figure 3-10). For a description of abbreviations used, refer to PAR. 3.3.9.1 To view previously saved settings refer to PAR 3.3.9.3. To save the power supply settings or modify previously saved settings refer to PAR. 3.3.9.3. To recall saved settings and apply them to the output refer to PAR. 3.3.9.5.

### 3.3.9.1 UNDERSTANDING ABBREVIATIONS USED FOR SAVED SETTINGS

The parameters listed in Table 3-9 are displayed, followed by a listing of the first 20 memory locations, displayed in two rows of ten. Use  and  keys to display additional columns or navigate to the desired location.

Locations that are not empty show an abbreviated representation of the saved settings. (To see **all** the pertinent settings for a particular location, highlight the location, then press ; press  to exit without modifying the settings.)

If either Voltage or Current mode were saved, the main channel setting is listed under the Main heading followed by **V** (voltage) or **A** (current), followed by either **f** (Output OFF), **n** (Output ON). If the reference type is ExtRefLevel (instead of Internal or External), the uppercase **V** or **A** is replaced by lowercase **v** or **a**. The protection setting is listed under the Prot heading.







If External mode was saved, the protection setting is followed by **C**, indicating that the mode (voltage or current is **C**onditioned by the external signal applied to pin 2 of the Analog I/O Port (see Table 2-5).

If the protection setting is followed by a minus sign (–) it indicates that the negative protection value (displayed) is set larger (absolute value) than the positive protection value (not shown on the list). Similarly, if the protection setting is followed by a plus sign (+) it indicates that the positive protection value (displayed) is set larger than the negative protection value (not shown on the list).

If Main channel reference was saved as External, **EXT** is listed under the Main heading. In this case the main channel reference uses the external voltage applied to pin 11 of the Analog I/O Input Port (see Table 2-5).

If Protection type was saved as External, **EXT** is listed under the Prot heading. In this case the protection settings are determined by the levels applied to the appropriate pins of the Analog I/O Input Port (see Table 2-5). If the main channel is voltage, the protection settings are determined by pin 5 (negative current protection) and pin 13 (positive current protection). If the main channel is current, the protection settings are determined by pin 6 (negative voltage protection) and pin 14 (positive voltage protection).

### 3.3.9.2 VIEWING SAVED SETTINGS

1. Pressing  from the power-up screen displays the Saved Setups screen (Figure 3-10) consisting of a list of locations 1 through 20 arranged in two columns of 10 rows. Use  and  keys to display additional columns.
2. Use the  and  keys to highlight the desired memory location; When the desired location is highlighted, press . The details of the parameters listed in Table 3-9 are displayed.

**TABLE 3-9. SAVE/RECALL MENU**

PARAMETER	CHOICES ( <b>BOLD</b> = Factory Default)	FUNCTION
NOTE: DEFAULT values for empty cells are the settings of the unit at the time the save/recall menu is entered.		
Mode of Operation	<p><b>Voltage</b> Current External</p>	<p><b>Voltage</b> - Selects voltage mode. Voltage value determined by SETTING.  <b>Current</b> - Selects current mode. Current value determined by SETTING.  <b>External</b> - Used for customized configuration where EXT VM/CM signal at pin 2 of I/O port controls mode; consult factory for details.</p>
Main Channel Reference    Main Setting	<p><b>Internal</b>  External  ExtRefLevel  nn.nnn or nnn.nnn (model and parameter dependent)</p>	<p><b>Internal</b>: Any external reference applied to the Analog I/O port pin 11 is ignored and the internal reference is established by SETTING field.  <b>External</b>: The internal reference is ignored, and the external reference applied to the Analog I/O port pin 11 is used (see PAR. 3.4.4.1).  <b>Extreflevel</b>: Allows the gain of the BOP to be established by the maximum output voltage or current introduced by the SETTING field. (see PAR. 3.4.4.2).  Sets the active channel setting. E.g., if Voltage mode is selected, nnn.nnn is voltage setting, if Current mode is selected, nn.nnn is current setting. If External mode is selected, Main Setting is not available.</p>
Protection Type   Positive  Negative	<p><b>Internal</b> External  LesserLimit  nn.nnn or nnn.nnn  nn.nnn or nnn.nnn</p>	<p><b>Internal</b> - Allows limits to be controlled by Positive and Negative values.  <b>External</b>: Allows limits to be controlled by analog signals applied to the analog port (see PAR. 3.4.5).  <b>LesserLimit</b>: Allows protect limit to be automatically selected from either 1) the external analog voltage applied to the Analog I/O port or 2) the value set in the Positive and Negative fields. Whichever limit has a lower absolute value (closest to zero) has effect (see PAR. 3.4.5).  This is the positive value for Voltage protect if Current mode is selected, or the positive value for Current protect if Voltage mode is selected. If External mode is selected, this field is not accessible.  This is the negative value for Voltage protect if Current mode is selected, or the negative value for Current protect if Voltage mode is selected. If External mode is selected, this field is not accessible.</p>
Output	<p><b>OFF</b>  ON</p>	<p><b>OFF</b> - Output disabled. The behavior of the unit when output is disabled depends on the LOAD TYPE setting (see PAR.3.3.7).  <b>ON</b> - Output enabled.</p>





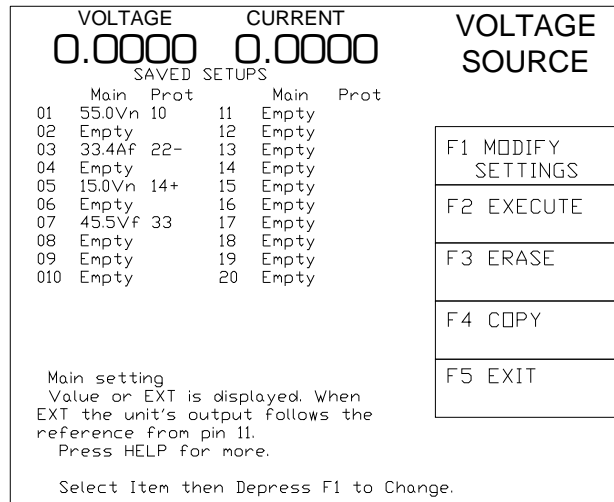

### 3.3.9.3 SAVING SETTINGS AND ERASING OR MODIFYING PREVIOUSLY SAVED SETTINGS

1. Press  from the power-up screen to enter the Saved Setups screen (Figure 3-10).









3042519-12

**FIGURE 3-10. SAVED SETUPS MENU**

2. Use the  and  keys to highlight the desired memory location; To erase a highlighted memory location, press . The list will show erased locations as **Empty**.
3. Press  to see the details stored in the highlighted location.
4. Once the details are displayed, use the  and  keys to highlight the desired parameter.

**NOTE:** If a value to be saved is beyond the range of the unit, the value saved will be limited to the maximum value. If the Mode is changed, the numerical values for the main and protection channels must be revised accordingly.

- To modify the parameter, press . Highlight the desired choice from a list, or use the keypad to enter a numeric value, then press  to save, or  to abort.
  - To exit without changing the parameter, press .
5. Continue to modify parameters as described in step 4 above. When all parameters have been modified, press  to save for power-up. Press  to exit without storing the changes.

**NOTE:** If the message CHANGES NOT ALLOWED is displayed, the memory location has been remotely locked (see PAR. A.12 for details).

6. After the changes have been saved, the unit returns to the Saved Settings screen, where the saved settings can now be applied to the output by pressing .

### 3.3.9.4 COPYING PREVIOUSLY SAVED SETTINGS TO A NEW LOCATION

1. Press **F1** from the power-up screen to enter the Saved Setups screen (Figure 3-10).
2. Use the **↓** and **↑** keys to highlight the location to be copied, then press **F4**.
3. Highlight an **Empty** location and press **F4** to save to the highlighted location, or press **F3** to abort the copy.

### 3.3.9.5 APPLYING SAVED SETTINGS TO THE OUTPUT (RECALL)

1. Press **F1** from the power-up screen to enter the Save/Recall menu.
2. Use the **↓** and **↑** keys to highlight the desired memory location. When the desired location is highlighted, press **F1** to view the detailed settings before execution, or press **F2** to apply the settings to the output. Refer to PAR. 3.3.9.3 to modify a setting before execution.

## 3.3.10 WAVEFORM GENERATION

### 3.3.10.1 PROTECTING THE LOAD WHEN ACCESSING WAVEFORMS



**CAUTION:** Before Pressing **F2** to enter the Saved Waveform Screen from the power-up screen, perform the following steps to avoid unexpected voltages or currents from previous settings being briefly applied to the load when the waveform is first executed.

1. Use the MODE key to set the operating mode of the unit (voltage or current) to correspond with the mode of the waveform.
2. Set the main channel to zero, and the protection channel to maximum. This ensures that the waveform will start from zero. Otherwise, between pressing STANDBY to turn the output on, and pressing **F4** to execute the waveform, the previously programmed settings of the power supply will be applied to the load until the waveform starts executing.

### 3.3.10.2 WAVEFORM OVERVIEW

After observing the precautions of PAR. 3.3.10.1, the Saved Waveforms screen (Figure 3-11) is entered by pressing **F2** from the power-up screen (Figure 3-4). Waveforms that have been previously saved will be displayed with the previously assigned names; waveforms that have been erased will appear as Empty. Up to 16 separate local waveforms can be programmed and stored from the front panel.

Waveforms may be programmed, stored and executed using LIST commands found in Appendix B. The interactive demo program portion of the Labview G driver for BOP 2KW (downloadable from the Kepco web site at <http://www.kepcopower.com/drivers/drivers-dl3.htm#bop1k>) provides examples of generating waveforms remotely. Documentation for the demo program

examples can be found in the Labview, VXI Plug&play Driver Manual for BOP-BIT available for download from the Kepco web site at <http://www.kepcopower.com/support/opmanls.htm#dvr>

Each waveform has an identifying name, the operating mode (voltage or current), the number of cycles (the number of times the complete waveform is to be repeated), positive and negative protection values. Setting the number of cycles to zero allows the waveform to repeat continuously.

A waveform is comprised of at least one, or as many as 10 segments. Each segment has an individually specified value for Type, Frequency or Period, Amplitude, Offset, Start angle, Stop angle, and Initial/Repeat; see Table 3-12 for details.

- |   |                        |
|---|------------------------|
| To view a previously saved waveform         | Refer to PAR. 3.3.10.4 |
| To create a new waveform                    | Refer to PAR. 3.3.10.6 |
| To execute a previously saved waveform      | Refer to PAR. 3.3.10.7 |
| To modify a previously saved waveform       | Refer to PAR. 3.3.10.8 |
| To create a complex waveform (with example) | Refer to PAR. 3.3.10.9 |

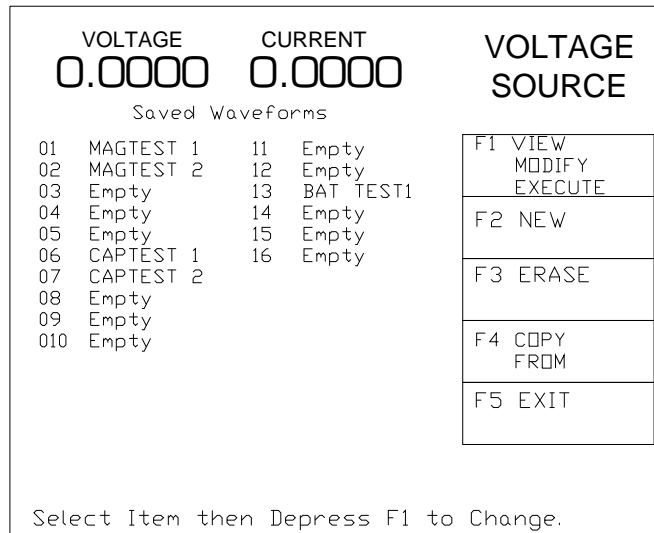

3042519-8

**FIGURE 3-11. SAVED WAVEFORMS MENU**

### 3.3.10.3 UNDERSTANDING HOW WAVEFORMS ARE GENERATED

Waveform are generated by the BOP by producing a series of discrete output levels (points) in a prescribed pattern. In the case of sine, triangle and ramps, this produces an output that conforms to an approximation of the selected waveform type. The number of points available for a waveform is limited to 3933 for all segments. Since there are a finite number of points, the lower the frequency, the more points used, and the smoother the output waveform will appear. As the frequency increases, fewer points are available for each cycle and the resulting waveform may appear somewhat more jagged. Tables 3-10 and 3-11 list the number of points used for each frequency range of sine, triangle and ramp waveforms and for square waveforms, respectively. Levels use a maximum of 60 points.

This means that a waveform consisting of a single sinewave segment at 0.1 Hz will use all 3840 points to generate each cycle, while a sinewave at 440 Hz will use 24 points for each cycle. Note that a single segment between 0.01Hz and 1.8Hz uses all available points, so subsequent

segments will not be accepted. Four segments of 10Hz will be acceptable, while five segments at 10 Hz will not be accepted. Reducing the segment by using the start and stop angle will also reduce the number of points used.

Each time a segment is added, the waveform is validated. When a segment is added that causes the point total to exceed 3933, the error message "Input buffer overrun" will be displayed briefly. This can be corrected by either reducing the number of segments, or increasing the frequency of the existing segments until the point total is acceptable.

**TABLE 3-10. SINE, TRIANGLE AND RAMP WAVEFORM FREQUENCY VS. POINTS**

Frequency (See Notes 1, 2, and 3)		Total Points per segment	Frequency (See Notes 1, 2, and 3)		Total Points per segment
From	To		From	To	
0.01Hz <sup>4</sup>	2.7Hz	3840	55.5Hz	66.5Hz	160
2.71Hz	3.6Hz	2880	66.6Hz	88.7Hz	120
3.71Hz	5.5Hz	1920	88.8Hz	118.3Hz	90
5.6Hz	8.3Hz	1280	118.4Hz	147.9Hz	72
8.4Hz	11.0Hz	960	148Hz	177.4Hz	60
11.1Hz	14.7Hz	720	177.5Hz	221.8Hz	48
14.8Hz	22.1Hz	480	221.9Hz	295.8Hz	36
22.2Hz	33.2Hz	320	295.81Hz	354.9Hz	30
33.3Hz	44.3Hz	240	355.9Hz	443.7Hz	24 (See Note 2)
44.4Hz	55.4Hz	192	443.8z	532Hz	20 (See Note 3)

NOTES: 1. As the frequency varies within the range, the time interval per point varies proportionately.  
 2. Sine and Triangle segments can not exceed 443Hz.  
 3. Ramp segments can not exceed 532Hz.  
 4. 0.001 for sine and triangle.

**TABLE 3-11. SQUARE WAVEFORM FREQUENCY VS. POINTS**

Frequency (See Note 1)		Total Points per segment	Frequency (See Notes 1)		Total Points per segment
From	To		From	To	
0.02Hz	1.8Hz	3840	43.51Hz	58.0Hz	120
1.81Hz	2.7Hz	2880	58.01Hz	72.5Hz	90
2.71Hz	4.0Hz	1920	72.51Hz	87.0Hz	72
4.01	5.4Hz	1280	87.01Hz	108.7Hz	60
5.41	7.2Hz	960	108.71Hz	145.0Hz	48
7.21Hz	10.8Hz	720	145.2.9Hz	174.0Hz	36
10.81	16.3Hz	480	174.1Hz	217.5Hz	30
16.31Hz	21.7Hz	320	217.6Hz	261.0Hz	24
21.71Hz	27.1Hz	240	261.1Hz	435.0Hz	20
27.11Hz	32.6Hz	192	435Hz	652.5Hz	12
55.5Hz	66.5Hz	160	653 Hz	1000 Hz	10

NOTE: 1. As the frequency varies within the range, the time interval per point varies proportionately.

### 3.3.10.4 WAVEFORM SPECIFICATIONS

Refer to Table 1-2 for specifications applicable to waveforms created either locally, using the BOP front panel (Local) or remotely from a host computer, using LIST commands (Remote). Differences between local and remote operation are highlighted.

### 3.3.10.5 VIEWING STORED WAVEFORMS

After observing the precautions of PAR. 3.3.10.1, press **F2** from the power-up screen to access the Saved Waveforms screen (Figure 3-11). Use **↑** or **↓** or the encoder to highlight the name of a previously saved waveform, then press **F1** to view the Waveform Settings screen (see Figure 3-12). The lower half of the LCD shows a representation of the programmed waveform. The letters along the vertical axis of the graph at the lower left side indicate whether the waveform is programmed to operate in voltage or current mode. The message at the upper right indicates the actual mode of the power supply while the waveform is being executed. The upper half presents the waveform name, positive and negative protection settings, the repetition count, followed by a listing of segments. The type (square, sine, etc.), frequency, p-p amplitude, and whether the segment is initial (run only the first time) or repeating is indicated by I or R, respectively. To see the offset, start/stop angle, initial/repeat for a segment, use **↑** or **↓** or the encoder to highlight the segment, then press **F1** (Initial/Repeat is not available for the last segment, since the last segment must repeat). Use **↑** or **↓** to highlight the parameter, press **F1**, then set the value or highlight the desired setting and press **F4** to save for power-up or **F5** to abort and exit without changing the parameter.

NOTE: VOLTAGES SHOWN ARE FOR BOP 100-10MG

3042519-6

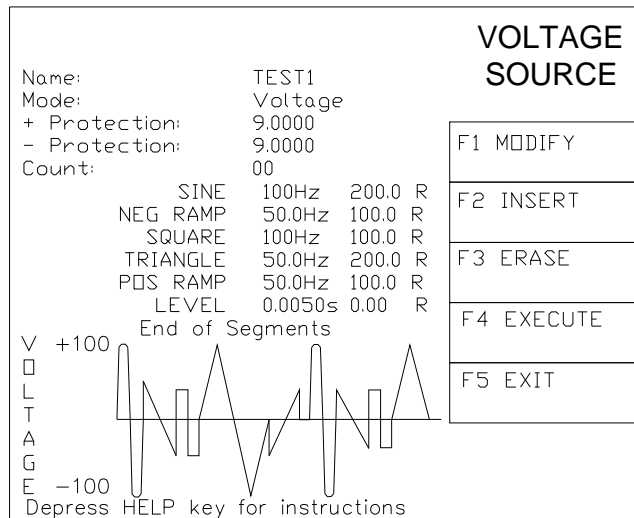

FIGURE 3-12. EDIT WAVEFORM MENU

### 3.3.10.6 CREATING A NEW WAVEFORM

1. After observing the precautions of PAR. 3.3.10.1, press **F2** from the power-up screen to enter the Saved Waveforms screen (Figure 3-11), highlight one of the waveforms designated **Empty**, then press **F2**. The New Waveform Menu screen (Figure 3-13) opens.



3042519-20

VOLTAGE 0.0000	CURRENT 0.0000	VOLTAGE SOURCE					
New Waveform Menu		<table border="1"> <tr> <td>F1 MODIFY SETTINGS</td> </tr> <tr> <td> </td> </tr> <tr> <td> </td> </tr> <tr> <td>F4 SaveFOR POWER UP</td> </tr> <tr> <td>F5 EXIT</td> </tr> </table>	F1 MODIFY SETTINGS			F4 SaveFOR POWER UP	F5 EXIT
F1 MODIFY SETTINGS							
F4 SaveFOR POWER UP							
F5 EXIT							
Waveform Name:							
Mode of Operation: Voltage							
Number of Cycles: 000							
Positive Protect: 38.400							
Negative Protect: 126.300							
First Segment							
Type:	Sine						
Frequency (Hz):	1.0000						
PtoP Amplitude	200.0000						
Offset:	0.0000						
Select Item then Depress F1 to Change							

**FIGURE 3-13. NEW WAVEFORM MENU**

- Assign a name to the waveform: highlight Name, press **F1** to modify, change the name using the **↑** or **↓** keys or **ADJUST** or the multiple presses of the numeric keys (see PAR. 3.2.4.1 for details). Press **F4** to save or **F5** to abort the change and exit.
- Refer to Table 3-13 and enter the desired settings for Mode of Operation, Positive and Negative Protection and Count. These settings apply to all waveform segments. (Note that the setting for mode cannot be changed once it has been saved; to change the mode, create a new waveform.) For each parameter listed in Table 3-13 use **↑** or **↓** or **ADJUST** to highlight the parameter, then press **F1** to edit, change the parameter, then press **F4** to save or **F5** to abort and exit.
- Refer to Table 3-12 and enter the parameters for the first segment: Type, Frequency, Amplitude (p-p) and Offset. For each parameter use **↑** or **↓** or the encoder to highlight the parameter, then press **F1** to edit, change the parameter, then press **F4** to save or **F5** to abort and exit.
- When segment is complete, press **F4** to save for power up. Continue to add segments as desired by pressing **F2**.

**NOTE:** When the first segment is added, start/stop angle is not accessible, however this can be modified once the segment has been added.

- When adding a new segment, the parameters of the highlighted segment are copied. It is not possible to move or copy a segment to another location. Refer to Table 3-12, Note 3 for details about initial vs. repeating segments. Refer to PAR. 3.3.10.9 for a detailed example of how to add segments to build a complex waveform.

**TABLE 3-12. WAVEFORM SEGMENT DETAILS MENU**

SETTING	CHOICES	FUNCTION
Type	Square + Ramp - Ram Triangle  Sine  Level Trigger  Slope  ZDEC  ZINC	Square - Square wave, bipolar, starts with positive excursion (see Note 3). + Ramp - Increasing ramp, bipolar (see Note 3). - Ramp - Decreasing ramp, bipolar (see Note 3). Triangle - bipolar, starts with positive excursion, start/stop angle may be user controlled (see Note 3). Sine - - bipolar, starts with positive excursion, start/stop angle may be user controlled (see Note 3). Level - value determined by offset., duration determined by Period. Trigger - Determines whether high level, low level or high-to-low edge is required at trigger port to allow waveform to continue. NOTE: Offset does not affect trigger, 0V offset is recommended. Slope - Unit uses last output level and new level to create a linear stepped transition to the new setpoint in the time specified. It is different from ramp in that it attempts to use single LSB steps if possible in the transitions and can use up to three different time periods. ZDEC - ZDEC Decrement to Zero. The following segments are decreased in amplitude. Starting from the amplitude specified, subsequent steps are decreased in amplitude, with the final step having an amplitude of zero. ZINC - ZINC Increment from Zero. The following segments are increased in amplitude. Starting from zero, subsequent steps are increased in amplitude, with the final step having p-p amplitude specified for the waveform
Frequency (Hz) or Period (Sec) for Level only, or Steps for ZDEC or ZINC	xxxx.xxx (Hz) or xx.xxxx (Seconds) xx (no. of steps) (see Note 2.)	Square wave: 0.02 to 990 Hz Ramp: 0.02 to 532 Hz Sine or Triangle: 0.001 to 443 Hz Level: Period in Seconds. 0.0001 to 5.0000 Seconds Slope: Period in Seconds. 0.03 to 4.0 Seconds
Amplitude (P to P)	xxx.xxx (Volts or Amperes)	Peak to peak amplitude of segment. Volts or Amperes determined by mode selected for waveform. Value within model rating acceptable (e.g., for BOP 100-10MG, maximum amplitude is 200V). Values that exceed the maximum or minimum software limits (see PAR. 3.3.4.2) are neither accepted nor executed.
Offset	xxx.xxx (Volts or Amperes)	DC level on which the waveform (centered) will ride or Amplitude for Level segments. Volts or Amperes determined by mode selected for waveform. E.g. for BOP 100-10MG, to specify a positive ramp that goes from +30V to +80V, set amplitude to +50V and offset to +55V. Since p-p amplitude of segment is centered on offset, it is possible for the waveform to exceed the model ratings (e.g., for the BOP 100-10MG, if the amplitude is set to 150V and the offset is -50V, the negative portion of the segment will exceed the -100V maximum of the model). In this case the output is clamped to the max/min software limit in effect (see PAR. 3.3.4.1). Values that exceed the maximum or minimum software limits (see PAR. 3.3.4.2) are neither accepted nor executed. Offset is not supported when ZDEC or ZDEC parameters are used.
<p><b>NOTES</b></p> <ol style="list-style-type: none"> <li>All waveforms except Level are centered on the offset. E.g. for a BOP 100-20MG, a positive ramp of 100V p-p amplitude, 10V offset, will start at -40V and increase to +60V over the time period (T) determined by the frequency (F): <math>T = 1/F</math>.</li> <li>If the internal memory space used to process a waveform segment is exceeded, *** is displayed to the left of the segment(s) in error. This can be corrected by 1) increasing the frequency (the lower the frequency, the more memory is used), 2) reducing the number of segments.</li> </ol>		

**TABLE 3-12. WAVEFORM SEGMENT DETAILS MENU**

SETTING	CHOICES	FUNCTION
Start Angle (Sine or Triangle only)	xxx x (degrees)	The point at which the sine or triangle waveform segment starts. Values from 0.0° to 360.0° are acceptable. Default is 0.0°.
Stop Angle (Sine or Triangle only)	xxx x (degrees)	The point at which the sine or triangle waveform segment stops. Values from 0.0° to 360.0° acceptable. Default is 0.0° (functions the same as 360°).
Initial/ Repeat	Repeating Initial	Repeating - Segment is executed for each cycle specified by the Count (see Note 3). Initial - Segment is executed only on the first count and skipped for all subsequent counts. Useful for preconditioning applications (see Note 3). All segments except the last may be set to Initial or Repeating. The last segment is always Repeating
<p>NOTES</p> <p>3. When starting a new waveform, the first segment is always a repeating segment. One or more initial segments can be inserted before the first repeating segment. Segments inserted before an initial segment are automatically set to initial; segments inserted after a repeating segment are automatically set to repeating. It is recommended that the repeating segments be created first. E.g. For a waveform with five segments, 1 and 2 designated Initial and 3, 4, and 5 designated Repeating. If the count was set to 10, the first waveform would be comprised of segments 1 through 5, but the next nine waveforms would only have segments 3, 4, and 5. This feature can be useful for establishing an initial delay or preconditioning the load prior to running the repeating waveform.</p>		



**TABLE 3-13. NEW WAVEFORM SETTINGS MENU**

SETTING	CHOICES	FUNCTION
Name	Alphanumeric characters (10 characters max.) (Name Assigned by User)	Waveforms are assigned a number from 1 to 16. When a new waveform is programmed, a name must be assigned so it can be easily recognized and recalled. Up to 16 waveforms can be stored from the front panel.
Mode of Operation	VOLTAGE CURRENT	Determines the active mode for the waveform. This setting cannot be changed once it has been saved. To change the mode, create a new waveform and delete the existing waveform.
Number of Cycles	0-999	Determines how many times the waveform is to be repeated, except for segments marked Initial, which are only executed once. To repeat the waveform indefinitely, set the count to 0
Protection Positive Negative		Assigns the positive and negative protect levels to be in effect while the waveform is running. These levels apply to the complementary channel. (e.g., if the Mode selected is voltage, the complementary channel is the current channel.
First Segment		
Type:	Square +Ramp -Ramp Triangle  Sine  Level Trigger  Slope	Square - Square wave, bipolar, starts with positive excursion (see Note 3). Pos Ramp - Increasing ramp, bipolar (see Note 1). Neg Ramp - Decreasing ramp, bipolar (see Note 1). Triangle - bipolar, starts with positive excursion, start/stop angle may be user controlled (see Note 1). Sine - bipolar, starts with positive excursion, start/stop angle may be user controlled (see Note 1). Level - value determined by offset., duration determined by Period. Trigger - Determines whether high level, low level or high-to-low edge is required at trigger port to allow waveform to continue. NOTE: Offset does not affect trigger, 0V offset is recommended. Slope - Unit uses last output level and new level to create a linear stepped transition to the new setpoint in the time specified. It is different from ramp in that it attempts to use single LSB steps if possible in the transitions and can use up to three different time periods.
<p>NOTES</p> <p>1. All waveforms except Level are centered on the offset. E.g. for a BOP 100-10MG, a positive ramp of 100V p-p amplitude, 10V offset, will start at -40V and increase to +60V over the time period (T) determined by the frequency (F): <math>T = 1/F</math>.</p>		

**TABLE 3-13. NEW WAVEFORM SETTINGS MENU (CONTINUED)**



SETTING	CHOICES	FUNCTION
Frequency (Hz)		Square wave: 0.02 to 990 Hz (0.02 to 0.74Hz if ZINC or ZDEC used) Ramp: 0.02 to 532 Hz (0.02 to 2.7Hz if ZINC or ZDEC used) Sine or Triangle:0.001 to 443 Hz (0.001 to 0.75Hz if ZINC or ZDEC used) Level or Slope: Period in Seconds. 0.005 to 5.0000 Seconds (0.2 Seconds minimum if ZINC or ZDEC used)
Period (Level or Slope only)	xx.xxxx (Seconds)	Level or Slope: Period in Seconds. 0.005 to 5.0000 Seconds (0.2 Seconds minimum if ZINC or ZDEC used)
Steps (ZINC or ZDEC only)	xx (no. of steps)	ZINC or ZDEC: Number of steps from 3 to 50
PtoP Amplitude	xxx.xxx (Volts or Amperes)	Peak to peak amplitude of segment. Volts or Amperes determined by mode selected for waveform. Value within model rating acceptable (e.g., for BOP 100-10MG, maximum amplitude is 200V). Values that exceed the maximum or minimum software limits (see PAR. 3.3.4.2) are neither accepted nor executed.
Offset	xxx.xxx (Volts or Amperes)	DC level on which the waveform (centered) will ride or Amplitude for Level segments. Volts or Amperes determined by mode selected for waveform. E.g. for BOP 100-10MG, to specify a positive ramp that goes from +30V to +80V, set amplitude to +50V and offset to +55V. Since p-p amplitude of segment is centered on offset, it is possible for the waveform to exceed the model ratings (e.g., for the BOP 100-10MG, if the amplitude is set to 150V and the offset is -50V, the negative portion of the segment will exceed the -100V maximum of the model). In this case the output is clamped to the max/min software limit in effect (see PAR. 3.3.4.1). Values that exceed the maximum or minimum software limits (see PAR. 3.3.4.2) are neither accepted nor executed.

**3.3.10.7 EXECUTING A WAVEFORM**





After observing the precautions of PAR. 3.3.10.1, press  from the power-up screen to enter the Saved Waveforms screen (Figure 3-11). Highlight one of the stored waveforms, then press . If the unit is in Standby, press the **STANDBY** key to turn the output on, then press  to execute the waveform.





To stop execution, press . This stops waveform execution. Depending on the setup of the Display settings (see Figure 3-7 and Table 3-3), the unit will stop the waveform and leave the BOP in one of three states. 1) Standby - the output will be off (STANDBY indicator on). 2) The BOP output will be at some random point in the programmed waveform. 3) The BOP will complete the waveform cycle and leave the output at the last point of the waveform.

To change the Waveform Stop setting, press  from the power-up screen (Figure 3-4), Highlight Waveform Stop (see Figure 3-7), then press , highlight Output OFF or User option.

When output OFF is chosen, an executing waveform can be stopped by pressing  STOP OUTPUT OFF. As soon as  is pressed the output is set to OFF (STANDBY indicator lit) and the waveform stops executing and returns to 0V, 0A.

When User Option is chosen, Stop Output OFF is still available by pressing  but two additional options are presented for stopping an executing waveform:

 Stop Immediate - Press  to select Stop Immediate. When waveform is stopped ( pressed), output freezes at whatever level the waveform was at when  was pressed.

 Stop & End Cycle - Press  to select Stop & End Cycle. When waveform is stopped (either count complete or  pressed), waveform runs through full cycle. The output stops at the last generated value of the waveform (e.g., for a sinewave segment of 0° to 270°, 10V amplitude, 0V offset, when  is pressed the output will end up at -10V).

While the waveform is executing, the display shows a graphic of the programmed waveform (repeating segments only) below the message **Waveform Executing**.













**Be sure that output power is OFF (Standby indicator lit) while connecting monitoring device. Be sure that connections are secure and that terminals are not inadvertently shorted.**

It is recommended that an oscilloscope be used to view the actual output. Connect the oscilloscope across OUT S and COM S terminals of the rear panel terminal block to monitor the output at the load, or between OUT MON and COM MON to monitor the BOP output at the BOP (see Figure 2-1).

### 3.3.10.8 MODIFYING PREVIOUSLY STORED WAVEFORMS

To edit a previously stored waveform, first observe the precautions of PAR. 3.3.10.1, then view the waveform and highlight the segment to edit as specified in PAR. 3.3.10.4. (The operating mode can not be edited; to change from a voltage waveform to a current waveform, refer to PAR. 3.3.10.9 to start a new waveform.)

Use  or  or **ADJUST** to highlight the segment, then press  to edit,



When editing a segment, a submenu showing the parameters for that segment will open (see Table 3-12). Use  or  or the encoder to highlight the parameter, then press  to edit, change the parameter, then press  to save or  to abort. Then press  to save for power p or  to abort and exit without saving the segment parameters that were edited.

To delete a segment, highlight the segment at the Waveform Settings screen (Figure 3-12), the press , to permanently erase the segment. This change is saved immediately and can not be undone.

To add a segment, at the Waveform Settings screen (Figure 3-12) highlight the segment following the one to be added (e.g., if there are three existing segments (1, 2, 3), to add a segment between 2 and 3, highlight 3. To add a segment following 3, highlight **End of Segments**. After highlighting the segment, press  to insert a new segment. The parameters applicable to the waveform type selected (see Table 3-12 for details) can then be modified as desired.

### 3.3.10.9 USING SEGMENTS TO BUILD A WAVEFORM

The following steps provide detailed instructions to illustrate how a complex waveform, illustrated in Figure 3-14, may be created by building segments. Refer to PAR. 3.2.4 for details on changing parameters if needed.

1. After observing the precautions of PAR. 3.3.10.1, press  from the power-up screen to enter the Saved Waveforms screen (Figure 3-11), highlight a waveform designated **Empty** and press  to create a new waveform.

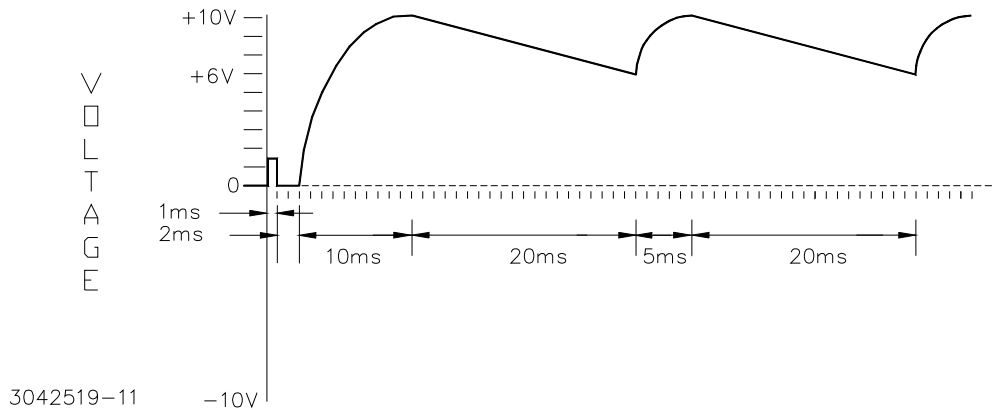

**FIGURE 3-14. SAMPLE WAVEFORM**

2. The initial waveform settings are displayed (see Table 3-12 and Table 3-13 for parameter details). Use **F1** to modify the initial settings for the waveform. For each parameter, use **F4** to save the setting.

Name	CAP CHARG
Mode	VOLTAGE
Protection	
Positive	10
Negative	10
Count	0
Segment	
Type	Neg Ramp
Frequency (Hz)	50
Amplitude (p-p)	4
Offset	8

When all settings are complete, press **F4** to save for power-up. This step creates a repeating negative ramp starting at +10V decreasing to +6V since it is a 4V p-p signal riding on an 8V offset. The frequency of 50 Hz establishes the time duration of 20 ms for the segment.

3. From the Waveform Settings screen, highlight segment NEG RAMP 50.0HZ 4.00 R and press **F2** to insert a new segment. Use **F1** to modify the following settings of the new segment. For each parameter, use **F4** to save the setting.

Type	Level
------	-------

Period (Sec)	0.002
Offset	0
Initial/Repeat	Initial

When complete, press **F4** to save for power-up. This step changes the 2ms, 0V level to be executed only once at the beginning of the waveform.

- From the Waveform Settings screen, highlight segment LEVEL 0.002s 0.00 I and press **F2** to insert a new segment. Use **F1** to modify the following settings of the new segment. For each parameter, use **F4** to save the setting.

Type	Level
Period (Sec)	0.001
Offset	1.5

When all settings are complete, press **F4** to save for power-up. This step creates a 1.5V level of 1ms prior to the 0V level. This segment is automatically set to Initial since the previous segment is set to Initial. The first two segments form a positive 2ms, pulse, delayed 1ms from the start of execution. The pulse can be used for synchronizing an external monitoring device.

- From the Waveform Settings screen, highlight segment NEG RAMP 50.0HZ 4.00 R and press **F2** to insert a new segment. Use **F1** to modify the following settings for the next segment. For each parameter, use **F4** to save the setting.

Type	Sine
Frequency (Hz)	25
P to P Amplitude	20
Offset	0
Start angle	0.0
Stop angle	90.0
Initial/Repeat	Initial

When all settings are complete, press **F4** to save for power-up. This step creates another initial segment which is the first quadrant of a 20V p-p sine wave riding on a 0V offset. It starts at 0V and rises to 10V (1/2 of 20) over 10 ms (1/4 of 40ms period established by 25Hz frequency). This segment simulates the initial charging of a capacitor.

- From the Waveform Settings screen, highlight End of Segments and press **F2** to insert the next segment. Use **F1** to modify the following settings for the next segment. For each parameter, use **F4** to save the setting

Type	Sine
Frequency (Hz)	50

Amplitude (p-p)     8  
 Offset                 6  
 Start angle           0.0  
 Stop angle            90.0

When all settings are complete, press **F4** to save for power-up. This step create a repeating 1/4 sine wave that starts at 6V and rises to 10V over 5 ms (1/4 of 20ms period established by 50Hz frequency). The waveform shown in Figure 3-14 has now been saved. Note that by careful calculation of period and start/stop angle, accurate waveform simulations can be attained.

7. Either execute the completed waveform by pressing **STANDBY** (to turn the output on), then **F4**, or press **F5** to return to the Saved Waveforms screen.

### 3.3.10.10 COPYING A WAVEFORM

After observing the precautions of PAR. 3.3.10.1, press **F2** from the power-up screen to enter the Saved Waveforms screen (Figure 3-11). Highlight one of the stored waveforms, then press **F4**. Then highlight a waveform location designated **Empty** and press **F4** to save or **F5** to abort the change and exit. The copied waveform may then be modified and saved with a new name if desired (see PAR. 3.3.10.8).

### 3.3.11 RESET



**CAUTION:** Pressing **RESET** will cause voltage transients to appear at the output which may damage a connected load. Switch is recessed to prevent inadvertent activation.

Pressing **RESET** causes the power supply to execute a complete power on sequence to reset the power supply to the power up settings (see PAR. 3.3.8).

### 3.3.12 OPERATOR TESTING





The Test System submenu is entered by pressing **F5** from the power-up screen, then highlight Revision/Test and press **F1**. Upon power-up all tests are flagged as **Untested**. Table 3-14 lists the tests that can be run. Highlight the choice and press **F1** to run the selected test.

**TABLE 3-14. REVISIONS/TEST MENU**

SETTING	CHOICES ( <b>BOLD</b> = Factory Default)	FUNCTION
Serial Number	<b>(Cannot be highlighted)</b> nn	nn = unit serial number, also found on nameplate at rear panel.



**TABLE 3-14. REVISIONS/TEST MENU (CONTINUED)**

SETTING	CHOICES ( <b>BOLD</b> = Factory Default)	FUNCTION
Max Voltage Max. Current	<b>(Cannot be highlighted)</b> XX.0 YY.0	Displays rated output voltage and current of power supply, including all slaves connected in parallel or series.
TEST		
Display	Status (see NOTE below)	Shows primary (red, blue, green) and secondary (magenta, cyan, yellow) colors plus degrees of brightness. Press number keys 0 through 9 to change contrast.  shows background color selected. Press  to change background. Lower half of screen shows colors used with selected background. Press  to apply displayed conditions and exit.
Keypad	Status (see NOTE below)	Requires depressing keys indicated on LCD. This test requires pressing every key on the keypad, plus moving the ADJUST control clockwise and counterclockwise, with the ADJUST control depressed and released. As the keys and control function pass the tests, the corresponding function on the LCD is highlighted. When the last test is successful, the LCD displays "passed." The test must be completed within two minutes, otherwise a "Failed" indication is displayed.
LAN	Status (see NOTE below)	Sends commands and data to LAN interface and verifies data is correct. If LAN interface is not installed, test fails (see NOTE below).
Interface	Status (see NOTE below)	Automatic test, reports status messages (see NOTE below).
Serial	Status (see NOTE below)	Automatic test of serial port - requires installation of loop back test connector. (see PAR. 3.5.6.4). Reports status messages (see NOTE below).
Analog	Status (see NOTE below)	Automatic test which does not affect unit output. Reports status messages (see NOTE below).
Output	Status (see NOTE below)	<b>WARNING: . DANGEROUS VOLTAGES ARE PRESENT AT THE OUTPUT TERMINALS: DO NOT TOUCH! DISCONNECT LOAD BEFORE RUNNING THIS TEST.</b>  Output is automatically programmed to +E <sub>Onom</sub> then -E <sub>Onom</sub> , then to 0V. Test duration is less than 2 Seconds. Reports status messages (see NOTE below).
Revisions	<b>(Cannot be highlighted)</b> v.vv w.ww x.xx y.yy z.zz	Displays current firmware revision for display, serial, GPIB, LAN and analog processors.
<p>NOTE: Test status is as follows:</p> <p>UNTESTED Initial status when first entering menu.</p> <p>TESTING Test is running.</p> <p>PASSED Test was successful.</p> <p>FAILED Test failed.</p> <p>FAIL EXT SERIAL test failed - verify loop back connector installed (see PAR. 3.5.6.4).</p>		

**3.3.13 ERROR MESSAGE EXPLANATIONS**

When a key press is not accepted, an error message is displayed at the bottom of the screen. Although recovery from most operator errors is obvious and simple, Table 3-15 lists all the error messages along with associated explanations as to why they occurred.

**TABLE 3-15. ERROR MESSAGE EXPLANATIONS**

ERROR MESSAGE	EXPLANATION
<b>General</b>	
Multiple Decimal places not supported	Decimal key was pressed while to the right of the existing decimal point.
Exceeding Maximum Allowed Value	To check maximums, go to power-up screen, press <b>F5</b> , highlight Max/Min Settings, press <b>F1</b> .
Sign does not affect Protection Limits	Protection Limit field is positive or negative, numerical value does not need sign
Entry incomplete, Depress ENTER key	When changing either the main channel or the protect channel, using the number keys, the change must be applied to the output by pressing <b>ENTER</b> before moving on to change the other channel.
Executing List	A waveform is currently executing via remote mode. Commands to change the output are not accepted until list is stopped (send command VOLT:MODE FIXED).
Save Disabled, Request ignored	Save Display Change is disabled. From power-up screen, press <b>F5</b> , highlight password settings to enable.
EXTERNAL MODE enabled.	<b>MODE</b> key does not function while Mode is being controlled externally. Press <b>F4</b> , highlight External Mode and change to Disable.
F2 Key not valid	F2 only works when labeled. Key was probably pressed inadvertently.
Password incorrect	Enter the correct password and press <b>F1</b> . If password has been lost and can not be recovered, refer to PAR. 3.6.3.11.1 to reset to factory defaults.
<b>Setup Menu</b>	
F3 - Invalid	<b>F3</b> only works when labeled. Key was probably press inadvertently.
F4 - Invalid	<b>F4</b> only works when labeled. Key was probably press inadvertently.
<b>Waveform Menu</b>	
External Reference Waveform not accessible	Reference Input must be set to Internal for waveforms to be executed. Press <b>F4</b> highlight Reference Input, press <b>F1</b> highlight Internal, press <b>F4</b> , then <b>F5</b> .
External Mode - Waveform not accessible	External Mode must be disabled for waveforms to be executed. Press <b>F4</b> highlight External Mode, press <b>F1</b> highlight Disable, press <b>F4</b> , then <b>F5</b> .
External Limits - Waveform not accessible	Protection Limit must be set to Internal for waveforms to be executed. Press <b>F4</b> highlight Protection Limit, press <b>F1</b> highlight Internal, press <b>F4</b> , then <b>F5</b> .
Empty Entry - use F2 instead	Empty location cannot be modified using <b>F1</b> Press <b>F2</b> to start new waveform.
No Room to insert - delete a segment.	No more than 10 segments are allowed in a waveform.
Unable to delete segment.	Try again. If still unable to delete segment, contact factory. for RMA.
Only EDIT allowed on Entry.	When viewing waveform, if name, count or protection levels are highlighted, press <b>F1</b> to modify the setting. <b>F2</b> and <b>F1</b> are not functional with these parameters.
MODE incorrect - Please Change	A voltage waveform was executed while the unit was in current mode or a current waveform was executed while the unit was in voltage mode. Press <b>MODE</b> key to change to correct mode, press <b>STANDBY</b> key to set output on then press <b>F4</b> to run the waveform
Unit in STANDBY - Please Change	Output must be on for the waveform to be executed. press <b>STANDBY</b> key to set output on then press <b>F4</b> to run the waveform
Can not delete Single Segment - use F1 to Change	Waveform must have at least one segment.
Can not delete the empty segment.	"End of Segments" was highlighted when <b>F3</b> - Erase was pressed. Move highlight to valid segment and try again.
Entry not Empty, Use F1 to change.	<b>F2</b> pressed while a previously saved waveform was highlighted. Use <b>F1</b> to modify or highlight Empty and press <b>F2</b> for a new waveform.
Under Minimum allowed value	Frequency or period was too small.
Frequency has no sign	+/- key is not functional when modifying frequency.
Use F5 to stop waveform.	<b>F4</b> not valid when waveform already executing.

### 3.4 ANALOG REMOTE MODE PROGRAMMING

The BOP can be programmed remotely using analog signals applied to the remote Analog I/O port at the rear panel (see Figure 2-1 and Table 2-5). Analog remote programming allows the user to 1) establish voltage or current mode (PAR. 3.4.3), 2) control the main channel using the BOP as a power amplifier (PAR. 3.4.4.1) and 3) establish the protection limits (PAR. 3.4.5). An output signal proportional to output current is also provided for external use (PAR. 3.4.6).

Analog mode may be configured remotely using either VOLT:MODE EXT (PAR. B.111) or CURR:MODE EXT (PAR. B.35) to enable the external reference in both voltage and current mode. Digital programming may be restored remotely by sending either VOLT:MODE FIX (PAR. B.111) or CURR:MODE FIX (PAR. B.35).

#### 3.4.1 SUPPRESSING NOISE AT THE OUTPUT

When using an externally grounded signal source, particularly when the BOP is powered from a single phase a-c input power source, undesirable noise may appear at the output. Noise suppression is accomplished by connecting a 100 $\mu$ F ceramic capacitor, rated at 50V or 100V (e.g., Kepeco P/N 117-1241), between GND and COM S terminals (see Figure 2-4 for local sensing or Figure 2-5 for remote sensing).

#### 3.4.2 REMOTE OUTPUT OFF

There are two ways to turn off the output using remote signals: (1) Remote Shutdown which requires the unit to be turned off, then on in order to restore operation and (2) Remote Standby which sets the output to OFF, putting the unit in STANDBY status.

##### 3.4.2.1 REMOTE SHUTDOWN

The unit can be shut down using a remote signal applied to the PROTECTION EXT. PORT as shown in Figure 3-15 or 3-16.

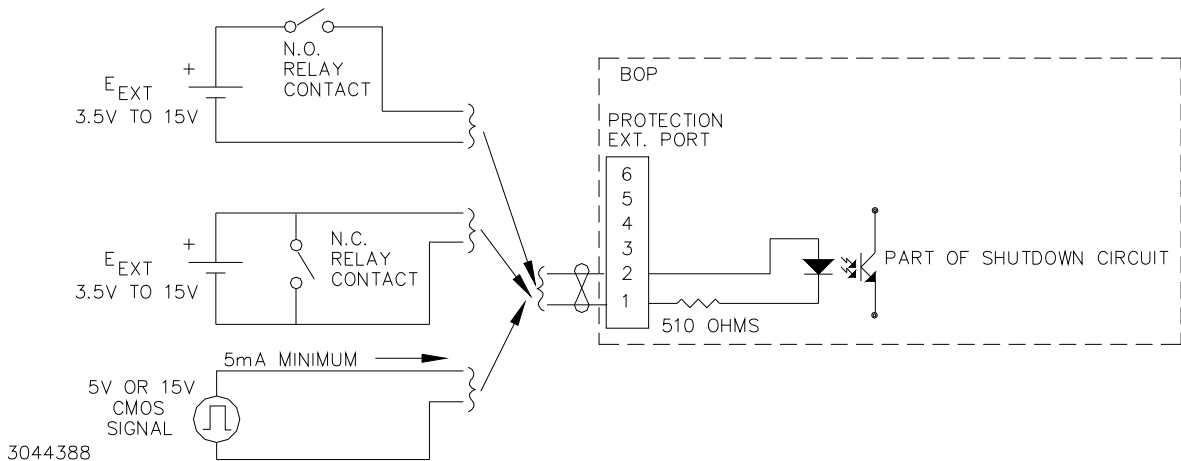
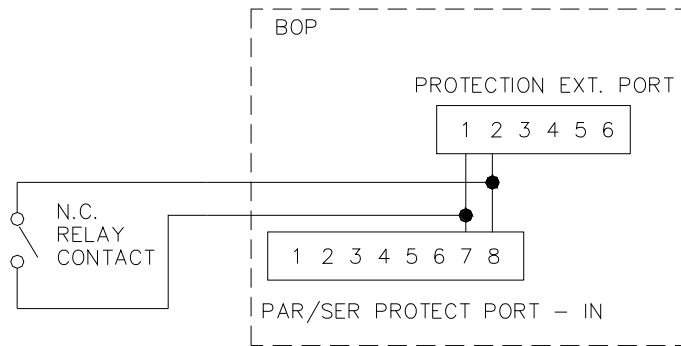

FIGURE 3-15. REMOTE SHUTDOWN USING EXTERNAL POWER

3044389

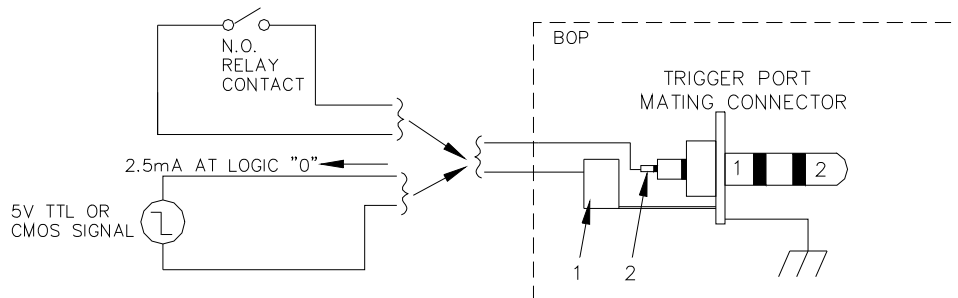

**FIGURE 3-16. REMOTE SHUTDOWN USING INTERNAL POWER**

### 3.4.2.2 REMOTE STANDBY

A BOP can be set to STANDBY status by applying a remote signal to the TRIGGER PORT as shown in Figure 3-17. Operation of the remote standby signal applied to the trigger port is configurable from the front panel (see PAR. 3.3.6) or remotely via OUTP CONT command (see PAR. B.23).\

3044390



**FIGURE 3-17. REMOTE STANDBY**

### 3.4.3 VOLTAGE/CURRENT MODE CONTROL

The mode of operation, voltage or current, can be programmed externally by applying a signal at pin 2, referenced to pin 9, of the Analog I/O port. Applying a TTL logic 1 (or open circuit) programs the unit to voltage mode. Applying a TTL logic 0 (or short) programs the unit to current mode.

To be functional this feature must first be configured from the front panel. From the power-up screen press **F4** to enter the Analog Remote Setup menu (see Table 3-16). Highlight External Mode, then press **F1**, highlight Enable and press **F4**. Press **F5** to apply the changes (without saving for power-up) and exit to the power-up screen or **F3** to abort. The Save/Recall feature (PAR. 3.3.9) can also be used to restore this setting upon power-up.

### 3.4.4 CONTROLLING THE OUTPUT USING THE BOP AS A POWER AMPLIFIER

The BOP can function as a power amplifier by means of the External Reference input at the Analog I/O port. This analog signal controls the main channel of the BOP. To use the BOP as a power amplifier see the following instructions for using the external reference: PAR. 3.4.4.1 for fixed gain, PAR. 3.4.4.2 for variable gain by establishing the maximum full scale output.

**TABLE 3-16. ANALOG REMOTE SETUP MENU**

SETTING	CHOICES ( <b>BOLD</b> = Factory Default)	FUNCTION
Reference Input Pin 11 (referenced to pin 10)	<b>Internal</b>  External  ExtRefLevel	<b>Internal:</b> Any external reference applied to the Analog I/O port pin 11 is ignored and the output is controlled using either the local front panel keypad (see PAR. 3.3.2) or remote SCPI commands (see Appendix B). <b>External:</b> The external reference applied to Analog I/O port pin 11 is used to control the output (see PAR. 3.4.4.1). The internal reference is ignored. <b>ExtRefLevel:</b> Allows the gain of the BOP to be established by the maximum output voltage or current introduced in the main channel field. (see PAR. 3.4.4.2).
Protection Limit Pins 5, 6, 13, 14 (referenced to pin 12)	<b>Internal</b>  External  LesserLimit	<b>Internal</b> - Allows the limits to be controlled by digital signals from either the keypad (local, see PAR. 3.3.2) or SCPI command (remote, see Appendix B). <b>External:</b> Allows the limits to be controlled by analog signals applied to the analog port; limits set from the keypad or SCPI command have no effect (see PAR. 3.4.5). <b>LesserLimit:</b> Allows protect limit to be automatically selected from either 1) the external analog voltage applied to the Analog I/O port or 2) the value set from the keypad or SCPI command). Whichever limit has a lower absolute value (closest to zero) has effect .
External Mode Pin 2 (referenced to pin 9)	<b>Disable</b>  Enable	<b>Disable</b> - Allows the main channel (voltage or current) to be selected by either the front panel MODE key or SCPI command. The condition of pin 2 of the Analog I/O port is ignored (see PAR. 3.3.2). <b>Enable</b> - The front panel MODE key and SCPI commands are prevented from affecting the active channel. Mode is determined by pin 2 of the Analog I/O port (see PAR. 3.4.3). This function cannot be saved for power-up.
NOTE: Power-up state for Reference Input and Protection Limit are established by Power-up Settings Menu (PAR. 3.3.8) under General Setup Menu (Figure 3-8).		

#### 3.4.4.1 FIXED GAIN USING EXTERNAL REFERENCE CONTROL

The main channel of the BOP, either voltage in voltage mode or current in current mode, can be controlled by an external reference voltage, 0 to  $\pm 10V$  applied at pin 11, referenced to pin 10, of the Analog I/O port. The input impedance for this signal is 20K ohms. This feature is enabled as follows:

1. From the power-up screen, press **F4**, highlight Reference Input and press **F1**. Highlight External and press **F4** to save. Then press **F5** to apply the changes (without saving for power-up) and exit. NOTE: This setting can be saved for power-up only by using the password-protected Power-up Settings menu (see {PAR. 3.3.8}), otherwise internal references are used for both main and protection channels upon power-up.
2. To return to digital or local control, from the power-up screen press **F4**, then highlight Reference Input and press **F1**. Highlight Internal and press **F4** to save. Then press **F5** to apply the change and exit.

NOTE: Each time the Reference Input setting is changed, the unit generates an internal \*RST reset command (see PAR. A.11) which requires the BOP output and/or protection limits to be reprogrammed.

When the external reference is used, the BOP functions as a power amplifier, amplifying the external reference at pin 11 to produce the output.

The nominal (inherent) voltage gain of each model is calculated by  $(G_{\text{NOM-V}}) = E_{\text{Onom}} / E_{\text{REF}}$  and nominal (inherent) current gain is  $(G_{\text{NOM-I}}) = I_{\text{Onom}} / E_{\text{REF}}$ . Thus the nominal gain is the ratio between the nominal (rated) voltage or current ( $E_{\text{Onom}}$  or  $I_{\text{Onom}}$ ), and the external reference ( $E_{\text{REF}}$ ) used to produce that output.

So for an external reference of  $\pm 10\text{V}$ , the nominal voltage gain  $(G_{\text{NOM-V}}) = E_{\text{NOM-V}}/10$ , e.g., the voltage gain of a BOP 36-56MG is  $36/10 = 3.6$ . The nominal current gain  $(G_{\text{NOM-I}})$  is  $I_{\text{NOM-V}}/10$ , e.g., the current gain of a BOP 36-56MG is  $56/10 = 5.6$ .

The external reference voltage may be d-c, a-c, or a combination of a-c plus d-c. The maximum frequency of an a-c signal should be below the inherent frequency response of the BOP (2KHz for voltage, 800Hz for current (see Table 1-2). For parallel or series combinations, the frequency response is reduced as specified in the instruction manual included with the cable kit. A frequency that exceeds the bandwidth of the BOP will cause the output to be distorted.

For linear response (input vs. output) the software limit (see 3.3.4.1) should be set to nominal and the maximum peak value (d-c plus a-c) of the reference signal must not exceed  $\pm 10\text{V}$ . If the input signal exceeds the limit value (either  $\pm 10\text{V}$  if the software limit is set to nominal, or a lesser voltage for a user-determined software limit) clipping of the output voltage or current to the limit will occur.

NOTE: If the system limits have been modified (PAR. 3.3.4), the output of the power supply will never exceed the modified system limits. E.g, for a BOP 36-56MG, if the system voltage limit is modified to  $\pm 18\text{V}$ , applying a positive analog voltage to pin 11 that starts at zero and rises to  $+10\text{V}$  causes the output to rise from zero and reach  $+18\text{V}$  when the external reference reaches  $+5\text{V}$ . The output stays at  $+18\text{V}$  while the reference increases from  $+5\text{V}$  to  $+10\text{V}$  since the system voltage limits for this example are  $\pm 18\text{V}$ .

#### 3.4.4.2 VARIABLE GAIN USING EXTERNAL REFERENCE LEVEL

The BOP can function as a variable gain power amplifier for both voltage and current modes, similar to the fixed (inherent or nominal) gain amplifier as described in PAR. 3.4.4.1. The user can determine a new (lower) full scale output value for the  $\pm 10\text{V}$  reference level (applied at pin 11, referenced to pin 10, of the Analog I/O port) by configuring the Reference input as follows:

1. From the power-up screen press **F4** and highlight Reference Input. Press **F1**, highlight ExtlRefLevel and press **F4**. Then press **F5** to apply the changes (without saving for power-up) and exit.
2. To return to digital or local control, from the power-up screen, press **F4**, then highlight Reference Input and press **F1**. Highlight Internal and press **F4** to save. Then press **F5** to apply the changes (without saving for power-up) and exit.

NOTE: Each time the Reference Input setting is changed, the unit generates an internal \*RST reset command (see PAR. A.11) which requires the BOP output and/or protection limits to be reprogrammed.

The adjustment range of the gain is between zero and 100% of the nominal gain, but 10% is recommended as the minimum value.

For an external reference of  $\pm 10V$ , the nominal voltage gain ( $G_{NOM-V}$ ) of a BOP 36-56MG is  $36/10 = 3.6$ . If the new full scale voltage for 10V is set to 29V, the voltage gain is changed from 3.6 to  $29/10 = 2.9$ . The gain can be changed from the front panel, but the output is controlled by the external reference signal and can not be changed from the front panel.

New Gain = New Full scale set at front panel / External reference that produces Full scale output. This means that the External reference voltage, from +10V to -10V, can control the full scale output voltage from +29V to -29V. The gain range is between zero and the nominal gain of each model.

Once the feature is configured, the new full scale value is entered by changing the active setting value of the main channel. This determines the full scale output to be produced by a 10V external reference.

The gain in voltage mode is  $G_V = |V_{SET}|/10$  where  $|V_{SET}|$  is the absolute value of desired full scale voltage (in Volts) entered at the front panel.

The gain in current mode is  $G_A = |I_{SET}|/10$  where  $|I_{SET}|$  is the absolute value of desired full scale current (in Amperes) entered at the front panel.

NOTE: If the system limits have been modified (PAR. 3.3.4), the output of the power supply will never exceed the modified system limits.

### 3.4.5 EXTERNAL PROTECTION LIMITS

When Protect Limit on the Reference Menu is set to External, the protect limits are determined by four analog signals referenced to Ground (pin 12) which are applied to the Analog I/O Port (see Table 2-5).

To be functional this feature must first be configured either from the front panel, or by sending either CURR:MODE:PROT EXT (see PAR. B.39) or VOLT:MODE:PROT EXT (see PAR. B.115). From the front panel power-up screen press **F4**, and highlight Protect Limit. Press **F1** to modify, then highlight External and press **F4** to save. Then press **F5** to apply the changes (without saving for power-up) and exit.

**Only two signals are active**, affecting the complementary protect channel,  $\pm$ current protect limit for voltage mode and  $\pm$ voltage protect limit for current mode. A voltage between +1V and +10V at the following pins (referenced to Ground, pin 12) will control the corresponding protection parameter between 10% of the nominal value (see Figure 1-3) and the corresponding positive or negative nominal full scale value.

- **-I\_LIM\_EXT (pin 5)** - This +1V to +10V analog signal sets the negative current protect limit from 10% of the nominal value to -full scale current. +10V corresponds to rated minimum (maximum negative) current (e.g., for BOP 36-56MG, +10V sets negative current limit to -56A).

- **-V\_LIM\_EXT (pin 6)** - This +1V to +10V analog signal sets the negative voltage protect limit from 10% of the nominal value to –full scale voltage. +10V corresponds to rated minimum (maximum negative) voltage (e.g., for BOP 36-56MG, +10V sets negative voltage limit to –36V).
- **+I\_LIM\_EXT (pin 13)** - This +1V to +10V analog signal sets the positive current protect limit from 10% of the nominal value to full scale current. +10V corresponds to rated maximum current (e.g., for BOP 36-56MG, +10V sets positive current limit to +56A).
- **+V\_LIM\_EXT (pin 14)** - This +1V to +10V analog signal sets the positive voltage protect limit from 10% of the nominal value to full scale voltage. +10V corresponds to rated maximum voltage (e.g., for BOP 36-56MG, +10V sets positive voltage limit to +36V).

The maximum frequency of an a-c signal used for the external protection limit must be at least 100 times lower than the sampling rate of the external signal (100Hz), resulting in a bandwidth of 1Hz.

The external programming circuit must be able to sink 0.15mA maximum provided by the BOP. When the input is an open circuit, the corresponding input signal automatically goes to 20% above the nominal protection limit.

NOTE: Each time Protection Limit setting is changed, the unit generates an internal \*RST reset command (see PAR. A.11) requiring the BOP output to be reprogrammed.

### 3.4.5.1 USING BOTH LOCAL/DIGITAL AND EXTERNAL PROTECTION LIMITS

When Protect Limit on the Reference Menu is set to Lesser Limit, the protect limits are automatically selected from either 1) the external analog voltage applied to the Analog I/O port (see PAR. 3.4.5) or 2) the value set from the keypad or SCPI command. Whichever limit has a lower absolute value (closest to zero) has effect.

To be functional this feature must first be configured from the front panel. From the power-up screen press **F4**, and highlight Protect Limit. Press **F1** to modify, then highlight Lesser Limit and press **F4** to save. Then press **F5** to apply the changes (without saving for power-up) and exit. NOTE: Each time Protection Limit setting is changed, the unit generates an internal \*RST reset command (see PAR. A.11) requiring the BOP output to be reprogrammed.

### 3.4.6 MONITORING OUTPUT CURRENT USING AN ANALOG SIGNAL

The BOP provides an output analog signal, 0 to  $\pm 10V$ , that is proportional to the output current which is always available. This signal is available at pin 3, referenced to pin 10, of the Analog I/O port. To protect the BOP circuitry this signal is provided via a series 2K ohm resistor, thus requiring a high impedance monitoring device or instrument.

## 3.5 DIGITAL REMOTE MODE PROGRAMMING

BOP models may be digitally programmed over a control bus using SCPI (Standard Commands for Programmable Instruments). SCPI provides a common language conforming to IEEE 488.2 for instruments used in an automatic test system (see PAR. 3.6). The control bus used must be either the IEEE 488 standard communication bus (General Purpose Interface Bus, GPIB), or the RS 232C Serial Bus.

Refer to Table 2-2 for input/output signal allocations for communication via the GPIB and Table 2-4 for RS 232. All power supply functions available from the keypad can be programmed via



remote SCPI commands. In addition, some features that are not available from the keypad may be implemented using remote commands (see PAR. 3.5.1).

This section includes a discussion of GPIB bus protocols (PAR. 3.5.4), instructions for changing the GPIB address (PAR. 3.5.3.2.1), a discussion of the VISA (Virtual Instrumentation Software Architecture) driver supplied with the unit (PAR. 3.5.5), RS 232C Operation (PAR. 3.5.6), followed by a detailed explanation of SCPI programming (PAR. 3.6).

### **3.5.1 OPERATING FEATURES AVAILABLE ONLY BY REMOTE COMMANDS**

The following paragraphs describe features of the BOP that are not available from the front panel, but can be implemented using remote commands.

#### **3.5.1.1 MEASUREMENT CAPABILITIES**

The default measurement functionality continually samples the voltage and current and saves the samples in an array. Every 16 sample pairs the sample is averaged and compared to the previous measurement sample. If the new sample is more than a few LSBs different from the previous one, the new sample and the next sample are provided to both the SCPI processor and the front panel display. Once a difference from one sample to the next is within a few LSBs for 64 samples, the average is created for the 64 samples and provided to the SCPI processor and the front panel display. If the absence of a difference remains for 128 samples, the average of 128 measurement samples will be provided to the other processors. This time, from the first detected difference to the 128 average being provided to the unit, is defined as the unit settling time, and is available in the operating status register as bit 1.

The command MEASure:MODE can modify this settling behavior by changing it to SYNChronous mode. In SYNChronous mode, whenever the main channel set point or the protection levels are changed, the sample pair logic is reset to start a new 16 pair sample. The average of this sample will be forced to be different than the previous sample value. The measurement system continues to operate after this sample, providing the 64 and 128 sample averages as required. It is possible to ensure this first sample is returned by the measure command; paragraph 3.5.1.2.3 describes this in detail.

#### **3.5.1.2 MAXIMUM SETPOINT TO MEASUREMENT RESPONSE**

The maximum setpoint-to-measurement response specification has been added to the performance specifications. This specification defines the time between a voltage or current setpoint change to a valid measurement to be 55 milliseconds maximum. This specification assumes that the unit is in bipolar mode. This is accomplished by new SCPI commands/queries, modifying the \*WAI command and using the proper command string syntax required to implement the feature (see PAR. 3.5.1.2.3).

##### **3.5.1.2.1 NEW OR MODIFIED COMMANDS:**

- MEAS? new query - Used to measure both voltage and current without sending separate MEAS:VOLT? and MEAS:CURR? queries.
- SYST:MODE new command and query - Default setting is BIPolar to allow the unit to meet the 55 millisecond (maximum) specification. Can be set to UNIPolar to allow the unit to have the same programming interface as standard (current) production models.
- MEAS:MODE? Provides the ability to synchronous or asynchronous mode of measurement.

### 3.5.1.2.2 POWER-UP DEFAULTS

The power-up defaults are as follows:

SYSTem:MODE set to UNIpolar to be compatible with earlier firmware versions. When set to BiPolar, unit meets the 55 millisecond (maximum) specification. NOTE: When set to BiPolar, changing of the voltage setpoint in voltage mode **requires** using VOLT command to set voltage and CURR:PROT to set the current limit. Changing of the current setpoint in current mode **requires** using CURR command to set current and VOLT:PROT to set the voltage limit. When set to BiPolar no drivers are available.

MEAS:MODE set to ASYNc. When set to SYNC, the unit synchronizes set point changes with measurements to meet the 55 milliseconds (maximum) time specification. When set to ASYNc, the measurements are updated when a difference of 6 LSBs is detected in either a voltage or current measurement. In ASYNC measurement mode there is no correlation between measurements and set point changes and the unit can attain set point changes at a rate of 25 milliseconds per set point with a measurement; the measurement will be delayed from the set point by three commands.

### 3.5.1.2.3 HOW TO IMPLEMENT MAXIMUM SETPOINT TO MEASUREMENT SPECIFICATION

To initialize implementation of the maximum setpoint to measurement specification, send the following two commands.

- SYST:MODE BIP to set bipolar mode, requiring the use of CURR:PROT and VOLT:PROT to set the protection levels.
- MEAS:MODE SYNC to enable the synchronous mode where a setpoint change syncs the readback response of the unit.

After initializing, the set point change (either VOLT or CURR) must be immediately followed by \*WAI. Note that \*WAI has been modified to ensure that setpoint data is valid before executing the next command in the string. To meet the 55 milliseconds (maximum) specification all commands must be sent in a single commands string such as: CURR 4.80;:\*WAI;:MEAS:CURR? The MEAS:CURR command will return 4.80A within 55 milliseconds of sending the command string. The 4.80A will be within the unit's accuracy specifications (see Table 1-2) plus 10% of the setpoint value, representing the short term stabilization error. In addition, MEAS? query has been added to return both voltage and current measurements, followed by a status byte (see Table B-2)

If the same commands are sent in two separate command strings, e.g, CURR 4.80;:\*WAI followed by MEAS:CURR?, the response time is 63 milliseconds maximum.

If the three commands (CURR 4.80, \*WAI, MEAS:CURR?) are each sent separately, measurement accuracy is still the same but response time is 100 milliseconds maximum. Each separately sent \*WAI will add 30 milliseconds to the processing delays.

### 3.5.2 PROGRAMMING TECHNIQUES TO OPTIMIZE PERFORMANCE

#### 3.5.2.1 PROGRAMMING VOLTAGE/CURRENT LIMIT AND CURRENT/VOLTAGE LIMIT

Kepeco's auto-crossover digital supplies can operate in either voltage mode with current limit, or current mode with voltage limit. The operating mode is determined by the voltage and current commands received, as well as the load. Each time voltage and current commands are received, the unit must evaluate the commands and the load conditions to determine the necessary operating mode. Reducing the number of times this evaluation must be made is desirable because Kepeco's digital auto-crossover supplies employ two separate feedback loops. Each time there is a potential mode change, there is always an uncontrolled period of a few milliseconds while the two feedback loops compete for control of the output. By changing only the active parameter (e.g., voltage for voltage mode), there is no doubt as to what the operating mode will be, so the unit is never uncontrolled, response is quick and no transients are possible. Recommended programming techniques are:

1. Minimize programmed mode (voltage or current) changes. Unless absolutely required by the test parameters, allow the power supply to automatically switch modes as determined by the load. This will improve response time and reduce undesirable transients.
2. Once the mode (voltage or current) is programmed, program the active parameter to zero and the complementary limit parameter to the maximum anticipated for application. Then program only the active parameter. The active parameter is the parameter that controls the output, e.g., voltage controls the output in voltage mode.
3. Never program both the active and complementary limit parameter to zero. This can result in long response times. Set the active parameter to zero and the complementary limit parameter to a minimum, e.g., 10% of maximum, to ensure that the active mode is defined.

#### 3.5.2.2 MAKING SURE THE PREVIOUS COMMAND IS COMPLETE

Some SCPI commands require a flash memory update and can take an indeterminate amount of time to complete. These commands are:

- **\*SAV**
- **MEM:PACK** (\*\*)
- **MEM:UPD** (\*\*)
- **CAL:COPY**
- **CAL:SAVE**
- **SYST:PASS:NEW**
- **SYST:SEC:IMM** (\*\*)
- **SYST:SEC:OVER** (\*\*)

When sent via the GPIB, these commands require a query to be added to the command string to verify the previous command is complete. When the command is complete, the unit updates

the status byte and indicates MAV (Message Available, bit 4 - see Table A-3) is true. MAV indicates that there is a response to be received by the computer, so when it becomes set, the unit is ready for its next command after reading back the data from the query that was added to the command string. Although it is possible to wait for the response without sending a query, the time out period can be 1 minute or longer depending on the internal state of the non-volatile memory, up to 2 minutes for the syst:sec:imm and syst:sec:over commands.

When sending the above commands via the RS 232 bus, data flow control must be enabled (XON) for the unit to properly update flash memory.

The \*OPC? query is ideal to check if the previous command is complete since it returns either a 1 or 0. It is important that it be sent as a part of the same string as the command that causes a flash update. As an example, sending CAL:SAVE 12/31/2005;:\*opc? or \*opc?;:CAL:SAVE 12/31/2005 are valid command strings. Sending the commands separately will not verify that the previous command is complete. Figure 3-18 is a program written in C, incorporating these techniques.





**CAUTION:** The commands listed above with (\*\*) will generate a “-440, Missing Query” error if a query does not precede the command in the same command string or ;\*OPC? does not follow the command. Although commands not marked with (\*\*) will not generate an error, all commands listed above require verification to insure absolute success. **Failure to follow these rules can result in the loss of all stored constants and render the unit inoperative.**

For commands not marked with (\*\*) failure to provide a delay of about 1 minute can result in:

- Commands that are not processed,
- The following command may be received in error, causing an error in the transmission,
- Unit lock-up requiring power cycling of the unit. If working via the GPIB bus, sending Interface Clear and Device Clear followed by \*RST will unlock the unit.

### 3.5.3 REMOTE MODE SETUP

When one of the three interface ports are in use, PAR's 3.5.3.2 (GPIB), 3.5.3.3 (RS 232) and 3.5.3.4 (LAN) describe how to configure the port to meet the user's requirements.

After pressing  from the power-up screen, use  to cycle between the installed interfaces: Serial, GPIB and LAN. Only MG models support the GPIB interface. Only ME models support the LAN interface.

The High Power BOP can be substituted for a standard BOP that is currently being used with one of Kepco's BIT cards, however there are differences in operation (see PAR. 3.5.3.5 and 3.5.3.6).

The **SYSTEM:SET** and **SYSTEM:LANGUage** commands can be used to configure the BOP to operate in a manner similar to earlier models of Kepeco's 100W, 200W and 400W BOP power supplies.

```
#include <formatio.h>
#include <utility.h>
#include <gpib.h>
#include <ansi_c.h>

/*Overhead for the use of a NATIONAL INSTRUMENTS gpib interface */
int unit_desc; // handle for the national instruments controller
int GPIbus=0; // GPIB card 0
int adr=6; // Power Supply address
char status_byte; // status byte from the power supply

#define MAV 0x10 /* bit 4 of the status byte is the Message AVailable bit by 488.2 specification */

/* Function Send_with_wait

INPUT: string to be sent to power supply

Description: adds the *OPC? query and performs serial polls to wait for the command to be completed.

*/

int Send_with_wait(char *command);
char snd[501]; // data to be sent to the power supply
char rcv [10]; // data from power supply
int j;

sprintf(snd,"%s:*OPC?,command); // Add *OPC? to the command
// so there is a response from the
// power supply
Send(GPIbus, adr, snd, strlen(snd), 2); // Send the data to the power supply
for (j=0;j<500;j++){ // loop until ready (5 seconds max)
    Delay(.05); // Wait for command to complete
    ibrsp(unit_desc,&status_byte); // get status byte
    if ((status_byte& 0x10) ==0x10) break; // by looking for data in string
Receive (GPIbus, adr, rev, rev_buf_size,10); // so the error queue will not receive a 410 error
}

main( // test code to show operation of function.
    unit_desc=ibdev(GPIbus,adr,adr/256,T100ms,1,0x40a);Delay(.005);
    Send (GPIbus,adr,"VOLT 10;curr .01",sizeof("VOLT 10;curr .01"),NLEND;
    Send_with_wait("*SAV 10");
}
```

**FIGURE 3-18. PROGRAMMING EXAMPLE TO VERIFY PREVIOUS COMMAND HAS COMPLETED**

### 3.5.3.1 DETERMINING WHETHER \*RST COMMAND SETS THE OUTPUT OFF OR ON

When operating in remote mode, the Reset command \*RST (see PAR. A.11) can be configured to turn the output ON or OFF. Refer to PAR. 3.3.7 and Table 3-6 for a full explanation plus CAUTIONS and WARNINGS associated with setting the output on or off, depending on which load type is selected.

Press **F5** from the power-up screen, then highlight Interface Settings and press **F1** to enter the submenu (see Table 3-17). Highlight **\*RST set Output** and press **F1**, then highlight ON or OFF and press **F4** to save. Press **F4** to save for power-up or **F5** to apply the changes (without saving for power-up) and exit.

### 3.5.3.2 GPIB PORT SETUP (MG MODELS ONLY)

The following paragraphs describe the how to configure the GPIB port. Table 3-17 shows the menu for GPIB interface settings.







**TABLE 3-17. INTERFACE SETTINGS MENU**

SETTING	CHOICES ( <b>BOLD</b> = Factory Default)	FUNCTION
Interface Settings		
*RST set Output	<b>OFF</b> ON	OFF - Sending *RST causes output to go off (per IEEE 488.2 specifications) (see PAR. 3.5.3.3 for details). ON - Sending *RST causes output to go on (see PAR. 3.5.3.3 for details).
GPIB Interface Settings		
Language (This setting applies to all interfaces: LAN, GPIB and Serial.)	<b>SCPI</b> CIIIL	SCPI (Standard Commands for Programmable Instruments) - see PAR. 3.6. and Appendix B. CIIIL - Provides compatibility with early Kepco power supplies and controllers.
GPIB Address	0 - 30 ( <b>06</b> )	Assigns address used by external GPIB controller to communicate with BOP. GPIB address is not changed when factory defaults are restored by pressing <b>F2</b> .
Device Clear	<b>SCPI</b> MATE	SCPI - sending Device Clear (DCL) or selected DCL has no effect on output voltage and current per IEEE specification 488.2. MATE - When device clear is received, the power supply output is set to zero volts.
Serial Interface Settings		
Baud Rate	<b>OFF</b> 9600 19200 38400	Selects RS 232 serial port baud rate. Baud Rate is not changed when factory defaults are restored by pressing <b>F2</b> .
XON / XOFF	<b>ENABLE</b>  DISABLE	ENABLE - Allows BOP to control when data is received (see PAR. 3.5.6.2.1). DISABLE - Disables XON/XOFF. If both Serial XON/XOFF and Prompt functions are disabled, Echo mode is the default (see PAR. 3.5.6.2.2).
Prompt	<b>DISABLED</b> ENABLED  ECHO ENAB+ECHO	ENABLE - Enables Serial Prompt (see PAR. 3.5.6.2.3). DISABLE - Disables Prompt. If both Serial XON/XOFF and Prompt functions are disabled, Echo mode is set (see PAR. 3.5.6.2.2). ECHO - Enables Echo (see PAR. 3.5.6.2.2) mode. ENAB+ECHO - Enables Serial Prompt (see PAR. 3.5.6.2.3) and Echo (see PAR. 3.5.6.2.2) modes. Prompt is returned when the unit is ready and any received characters are echoed back to the sender.
NOTE: To restore all interface settings defaults, press <b>F5</b> from the power-up screen, highlight Interface Settings, press <b>F1</b> , then press <b>F2</b> to restore defaults shown above in <b>BOLD</b> . Press <b>F4</b> to save for power-up or <b>F5</b> to apply the changes (without saving for power-up) and exit.		

#### 3.5.3.2.1 CHANGING THE GPIB ADDRESS







The default address is 6. To change the GPIB address press **F5** from the power-up screen, then highlight Interface Settings and press **F1** to enter the submenu (see Table 3-17). Highlight GPIB Address and press **F1**, then use the number keys to enter the desired address and press **F4** to save. Press **F4** to save for power-up or **F5** to apply the changes (without saving for power-up) and exit. Note that GPIB address is not changed when factory defaults are restored by pressing **F2**.

### 3.5.3.2.2 ESTABLISH COMMUNICATION LANGUAGE

Communication via GPIB port can be executed using either SCPI or CIIL protocols. Press  from the power-up screen, then highlight Interface Settings and press  to enter the submenu (see Table 3-17). Highlight Language, press , highlight SCPI or CIIL and press  to save. Press  to save for power-up or  to apply the changes (without saving for power-up) and exit.

### 3.5.3.2.3 CONFIGURE DEVICE CLEAR (DCL) CONTROL







The device clear (DCL) and selected device clear can be set to operate in two modes. In the MATE mode, when the device clear is received, the output of the power supply is set to zero volts. In the SCPI mode sending DCL or selected DCL has no effect on output voltage and current as required by IEEE specification 488.2. The factory default value is SCPI mode.

To change the Device Clear configuration press  from the power-up screen, then highlight Interface Settings and press  to enter the submenu (see Table 3-17). Highlight Device Clear and press , then highlight SCPI or MATE and press  to save. Press  to save for power-up or  to apply the changes (without saving for power-up) and exit.







### 3.5.3.3 RS 232 SERIAL PORT SETUP

Paragraphs 3.5.3.3.1 through 3.5.3.3.3 below describe the setup required for the BOP to communicate via the RS 232C Serial bus using SCPI commands. Table 3-17 shows the menu for Serial interface settings.

#### 3.5.3.3.1 SELECT BAUD RATE

To change the Baud Rate configuration press  from the power-up screen, then highlight Interface Settings and press  to enter the submenu (see Table 3-17). Highlight Baudrate and press , then highlight OFF (to disable the serial port), 9600, 19,200 or 38400 and press  to save. Press  to save for power-up or  to apply the changes (without saving for power-up) and exit. Note that baud rate is not changed when factory defaults are restored by pressing .



#### 3.5.3.3.2 CONFIGURE XON/XOFF PROTOCOL

Press  from the power-up screen, then highlight Interface Settings and press  to enter the submenu (see Table 3-17). Highlight Baudrate and press , then highlight XON / XOFF and press . Highlight the desired option and press  to save, then press  to save for power-up or  to apply the changes (without saving for power-up) and exit.

**Enable** - Allows BOP to control when data is received (see PAR. 3.5.6.2.1 for a description of Xon/Xoff protocol).

**Disable** - Disables XON/XOFF. If both Serial XON/XOFF and Prompt functions are disabled, Echo mode is set (see PAR. 3.5.6.2.2 for a description of echo mode).

#### 3.5.3.3.3 CONFIGURE PROMPT MODE

Press  from the power-up screen, then highlight Interface Settings and press  to enter the submenu (see Table 3-17). Highlight Prompt and press , highlight the desired option and

press **F4** to save, then press **F5** to apply the changes (without saving for power-up) and exit, or press **F4** to save for power-up.

**Enable** - Enables Serial Prompt (see PAR. 3.5.6.2.3 for a description of prompt mode).

**Disable** - Disables Prompt. If both Serial XON/XOFF and Prompt functions are disabled, Echo mode is the default (see PAR. 3.5.6.2.2 for a description of Xon/Xoff mode).

**Echo** - Enables Echo (see PAR. 3.5.6.2.2) mode.

**Enab+echo** - Enables Serial Prompt (see PAR. 3.5.6.2.3) and Echo (see PAR. 3.5.6.2.2) modes. Prompt is returned when the unit is ready and any received characters are echoed back to the sender.

### 3.5.3.4 LAN INTERFACE SETUP (ME MODELS ONLY)



Paragraphs 3.5.3.4.1 through 3.5.3.4.6 below describe the setup required for the BOP 2KW-ME to communicate via the LAN interface using SCPI commands. Table 3-18 shows the menu for LAN interface settings.

**TABLE 3-18. LAN INTERFACE SETTINGS MENU**





SETTING	CHOICES ( <b>BOLD</b> = Factory Default)	FUNCTION
MAC	---	Read-only display of MAC address for the unit.
IP Address	<b>0.0.0.0</b>	Allows IP address to be set manually if both DHCP and AUTO IP are set to OFF. If either DHCP or AUTO IP are set to ON, provides read-only display of automatically generated IP address.
Address Mask	<b>255.255.255.0</b>	Allows IP mask to be set manually if both DHCP and AUTO IP are set to OFF. If either DHCP or AUTO IP are set to ON, provides read-only display of automatically generated IP mask.
DHCP	<b>ON</b> OFF	Set to ON allows automatic generation of IP address via DHCP server. Set to OFF allows IP address and IP Mask to be set manually if AUTO IP is also OFF
AUTOIP	<b>ON</b> OFF	Set to ON allows automatic generation of IP address without DHCP. Set to OFF allows IP address and IP Mask to be set manually if DHCP is also OFF
Host		
Name	Default = <b>XX YY SN</b> (e.g. 100_10_A654321)	XX = rated voltage, YY = rated current (Amps), SN = Unit serial number. Host Name can be changed as the user desires. Up to 12 ASCII characters are permitted. See also PAR. B.164.
Index	<b>0</b>	Index number (1 through 99) is automatically assigned: 1 for first unit found, subsequent identical units are assigned sequential index numbers to make the Host Name and Index a unique identifier. May be changed to an unused number between 1 and 99 if desired.
NOTE: To restore all LAN interface settings defaults, press <b>F5</b> from the power-up screen, highlight LAN Interface Settings, press <b>F1</b> , then press <b>F2</b> to restore defaults shown above in <b>BOLD</b> . Press <b>F4</b> to save for power-up or <b>F5</b> to apply the changes (without saving for power-up) and exit.		





### 3.5.3.4.1 SET IP ADDRESS

To set an IP address, Press  from the power-up screen, then highlight LAN Settings and press  to enter the LAN Interface Setting submenu (see Table 3-18). To allow automatic generation of an IP address set either DHCP (see PAR. 3.5.3.4.4) or AUTO IP (see PAR. 3.5.3.4.3) to ON.





To set the IP address manually, first set both DHCP (see PAR. 3.5.3.4.4) and AUTO IP (see PAR. 3.5.3.4.3) to OFF. From the LAN Interface Settings submenu highlight IP Address and press .

The IP address consists of four 3-digit fields separated by periods (decimal points). Each 3-digit field can be a maximum of 255 and is set independently. Use the  and  keys to highlight the right-most digit of a 3-digit field and use the number keys to modify the field. The first numbers entered scroll to the left until the 3-digit field is full. The highlighted digit can be incremented up or down using the UP or DOWN arrow keys. Use the  and  keys to move to another three digit field. When complete, press  to apply.







### 3.5.3.4.2 CHANGE IP ADDRESS MASK.

To set the Address Mask manually, first set both DHCP (see PAR. 3.5.3.4.4) and AUTO IP (see PAR. 3.5.3.4.3) to OFF. From the LAN Interface Settings submenu highlight Address Mask and press . Then enter the address mask as described above for IP Address (see PAR. 3.5.3.4.1). Press  to save for power up.







### 3.5.3.4.3 CONFIGURE AUTO IP

To configure the use of AUTO IP to set an IP address, press  from the power-up screen, then highlight LAN Settings and press  to enter the LAN Interface Setting submenu (see Table 3-18). Highlight AUTOIP and press  to modify the setting . Highlight OFF or ON and press  to apply, then press  to save for power-up.

### 3.5.3.4.4 CONFIGURE DHCP

To configure the use of DHCP to set an IP address, press  from the power-up screen, then use  and  keys until the display shows the current LAN settings (LAN SETTINGS highlighted). To modify, press  to enter the LAN Interface Setting submenu (see Table 3-18). Highlight DHCP and press  to modify the setting. Highlight OFF or ON and press  to apply, then press  to save for power-up.

### 3.5.3.4.5 CONFIGURE HOST NAME

To change the default Host Name, press  from the power-up screen, then use  and  keys until the display shows the current LAN settings (LAN SETTINGS highlighted). To modify, press  to enter the LAN Interface Setting submenu (see Table 3-18). Under Host, highlight Name and press  to modify the setting. Enter up to 12 ASCII Characters and press  to apply, then press  to save for power-up.

### 3.5.3.4.6 CONFIGURE INDEX

To configure the index number manually, press **F5** from the power-up screen, then use **↑** and **↓** keys until the display shows the current LAN settings (LAN SETTINGS highlighted). To modify, press **F1** to enter the LAN Interface Setting submenu (see Table 3-18). Under Host, highlight Index value and press **F1** to modify the setting. Enter up to 14 ASCII Characters and press **F4** to apply, then press **F4** to save for power-up.

### 3.5.3.5 BIT 4882 COMPATIBILITY.

The BOP 2KW is not directly compatible with the older linear BOP models using a BIT 4882 for digital remote control, as there are differences in behavior between the two: In response to the command line: `outp off;:volt 10` the BIT 4882 would set the output to 10 volts, while the BOP 2KW will remain in the output OFF state until `OUTP ON` is sent. The closest approximation to using the BOP 2KW to mimic the BOP/BIT 4882 is to use `OUTP:CONT ON` and `SYST:SET CM0` commands to configure the unit. The BOP 2KW response to the command line `outp off;:volt 10` would then be to set the output to OFF for 100 mS, then return to ON.

### 3.5.3.6 BIT 4886 COMPATIBILITY

Although the SYST:SET command can be used to configure the BOP 2KW the same way the BIT 4886 is configured, the BOP 2KW is not directly compatible with the older linear BOP models using a BIT 4886 for digital remote control. There are differences in behavior between the two in handling LIST commands, status reporting and trigger operation as described below.

#### 3.5.3.6.1 LIST COMMAND DIFFERENCES IN BIT 4886

The LIST commands of the older BOP/BIT 4886 are the same as the BOP 1K except as follows:

- LIST:DWELL - The BOP/BIT 4886 range is from 0.0005 to 5.0 Seconds while the BOP 2KW range is from 0.000091 to 0.034 Seconds. The BOP 2KW is faster but has less range than the BOP/BIT 4886.
- LIST:CLEAR sets the LIST:COUNT to 0 in the BOP 2KW but LIST:COUNT is set to 1 in the BOP/BIT 4886.
- The BOP 2KW has additional LIST commands not found in the BOP/BIT 4886.

### 3.5.3.6.2 STATUS REPORTING DIFFERENCES IN BIT 4886

The status register responses from the BOP 2KW and the BOP BIT/4886 are very different. If these commands are used, then changes will be required in the user's program. Commands affected are: **SYST:OPER**, **SYST:QUES**, **\*ESR** and **\*STB**.

### 3.5.3.6.3 TRIGGER OPERATION DIFFERENCES IN BIT 4886

The BOP/BIT 4886 only supports **\*TRG** while the BOP 2KW supports **TRIGGER:SOURCE EXTERNAL**, **BUS** and **IMMEDIATE**. The command **TRIG:SOUR BUS** must be sent before using trigger in the BOP 2KW.

### 3.5.4 IEEE 488 (GPIB) BUS PROTOCOL (MG MODELS ONLY)

Table 3-19 defines the interface capabilities of the BOP 2KW power supply (Talker/Listener) relative to the IEEE 488 (GPIB) bus (reference document *ANSI/IEEE Std 488: IEEE Standard Digital Interface for Programmable Instrumentation*) communicating with a Host Computer—Controller (Talker/Listener). Tables 3-20 and 3-21 define the messages sent by the BOP, or received by the BOP, via the IEEE 488 bus in IEEE 488 command mode and IEEE 488 data mode, respectively. These messages are enabled during the “handshake” cycle, with the BOP power supply operating as either a Talker or a Listener. (See PAR. 3.5.3.2 to change the GPIB address.)



**CAUTION:** To ensure correct operation, do not remove the GPIB cable from the BOP after a Query is processed. Ensure that the last command is a non-query such as **\*CLS** before removing the GPIB cable. Otherwise, power to the BOP and/or the host computer may need to be cycled OFF then ON to restore proper operation.

**TABLE 3-19. IEEE 488 (GPIB) BUS INTERFACE FUNCTIONS**

FUNCTION	SUBSET SYMBOL	COMMENTS
Source Handshake	SH1	Complete Capability (Interface can receive multiline messages)
Acceptor Handshake	AH1	Complete Capability (Interface can receive multiline messages)
Talker	T6	Basic talker, serial poll, unaddress if MLA (My Listen Address) (one-byte address)
Listener	L4	Basic listener, unaddress if MTA (My Talk Address) (one-byte address).
Service Request	SR1	Complete Capability. The interface sets the SRQ line true if there is an enabled service request condition.

**TABLE 3-19. IEEE 488 (GPIB) BUS INTERFACE FUNCTIONS (CONTINUED)**

FUNCTION	SUBSET SYMBOL	COMMENTS
Remote/Local	RL1	Complete capability. Interface selects either local or remote information. In local mode the BOP executes front panel commands, but can be set to remote mode via IEEE 488 bus. When in Remote mode all front panel keys are disabled except LOCAL function key. LOCAL function key can be disabled using keypad lockout command (see Appendix B, PAR. B.162) so that only the controller or a power on condition can restore Local mode.
Parallel Poll	PP0	No Capability
Device Clear	DC1	Complete Capability. BOP accepts DCL (Device Clear) and SDC (Selected Device Clear).
Device Trigger	DT1	Respond to *TRG and <GET> trigger functions.
Controller	C0	No Capability

**TABLE 3-20. IEEE 488 (GPIB) BUS COMMAND MODE MESSAGES**

MNEMONIC	MESSAGE DESCRIPTION	COMMENTS
ATN	Attention	Received
DAC	Data accepted	Received or Sent
DAV	Data Valid	Received or Sent
DCL	Device Clear	Received (see PAR. 3.5.3.2.2)
GTL	Go To Local	Not Supported. Use SYST:REM 0 instead (see PAR. B.175)
IFC	Interface Clear	Received
MLA	My Listen Address	Received
MTA	My Talk Address	Received
OTA	Other Talk Address	Received
RFD	Ready for Data	Received or Sent
SDC	Selected Device Clear	Received
SPD	Serial Poll Disable	Received
SPE	Serial Poll Enable	Received
SRQ	Service Request	Sent
UNL	Unlisten	Received
UNT	Untalk	Received

**TABLE 3-21. IEEE 488 (GPIB) BUS DATA MODE MESSAGES**

MNEMONIC	MESSAGE DESCRIPTION	COMMENTS
DAB	Data Byte	Received or Sent
END	End	Received or Sent
EOS	End of String	Received or Sent
RQS	Request Service	Sent
STB	Status Byte	Sent

### 3.5.5 BOP VISA INSTRUMENT DRIVER

The VISA instrument driver for the BOP power supply, available for download at [www.kepcopower.com/drivers.htm](http://www.kepcopower.com/drivers.htm), simplifies programming with a VISA compatible GPIB controller. Included are:

- source code (C) for all VISA functions (kp\_bophi.c)
- a complete programming reference manual (kp\_bophi.doc)
- a sample application of the VISA functions (written in C) which can be used to program one or more BOP power supplies using a virtual front panel observed on a computer monitor (kp\_appl.c)

Although the software drivers supplied by Kepco are VISA compliant, they also require the installation of the proper VISA driver from your GPIB card supplier. Many vendors supply this software with the hardware; National Instruments (<http://www.natinst.com>) has the driver for their cards available on the internet at a file transfer site (<ftp://ftp.natinst.com> — find the folder for support and VISA drivers).

### 3.5.6 RS232-C OPERATION

The BOP may be operated via an RS232-C terminal, or from a PC using a terminal emulation program. The default settings are as follows:

- Baud rate: OFF
- Parity: None
- Data Bits 8
- Stop Bits 1
- Prompt DISABLE
- XON/XOFF ENABLE

To change baud rate, or select prompt, echo or XON/XOFF, refer to PAR. 3.5.3.3 and Table 3-17.

#### 3.5.6.1 SERIAL INTERFACE

The serial interface behaves like the GPIB interface in that the command is parsed after receiving a control character of either a Line Feed or Carriage Return. The serial interface supports six special control characters. The four special control characters are:

Escape (1B <sub>H</sub> )	Causes the input buffer to be cleared. This character is used to ensure that the buffer is empty when the host powers on since it is possible that the BOP was previously powered on and received some characters prior to the initialization of the host computer.
Backspace (08 <sub>H</sub> )	Causes the last character in the input buffer to be removed from the input buffer queue.
Carriage Return (0D <sub>H</sub> )	Causes the input buffer to be parsed by the BOP.
Line Feed (0A <sub>H</sub> )	Causes the input buffer to be parsed by the BOP.

### 3.5.6.2 RS 232 IMPLEMENTATION

The following paragraphs are provided to help the user understand how the RS 232 serial interface is implemented in the BOP. Since the RS 232 protocol does not use a parity bit, The XON/XOFF method of communication is selected as the default to ensure “handshake” control of serial communication.

The echo mode is an optional method used to ensure reliable communication between the command originator (computer) and the BOP power supply, thus avoiding a more complex “handshake” protocol. When the BOP is in the RS 232 echo mode it returns all data sent to the host controller.

The BOP provides an additional option that allow handshake communication: the Prompt method. By using the handshake options (prompt and XON XOFF) the host controller can ensure that serial data interrupts occurring after parsing of the incoming message do not result in lost data.

DSR low (see Table 2-4) indicates the unit is not ready to receive data. DSR is low upon power up and goes high when the unit is ready for serial commands.

Referring to Figure 3-19, when a command string is sent it must be terminated by a CR or LF character. When the terminator character is received, the DSR line goes low and an optional XOFF character is sent to the host. The XON XOFF protocol can be disabled by the user. When disabled, the unit will not send XON XOFF characters via the serial port. XON XOFF characters received by the unit will have no effect on serial transmission. The host must always be ready to accept transmitted characters.

The commands are stored in a 256 byte FIFO (first in first out) buffer. Once a command string is received, any additional characters are stored in the buffer while the BOP responds by transmitting an XOFF character to the host requesting the host stop sending data. If more than 256 characters are received, the initial characters are lost; DSR stays low and XOFF is not transmitted to the host until all data in the buffer is processed.

If a line terminator is received during the buffering period, as soon as the first command string is complete, the next command string is processed.

When all commands have been received DSR goes high and an XOFF character is sent to the host requesting the host not send data while the BOP is processing the commands received. Once processing is complete, the unit sends XON repeatedly every five seconds if XON flow control is enabled. NOTE: DSR can not be disabled.

If an ESC character is received, the buffers are cleared and all data is lost.

Note: When using DSR, most windows PC computers require that CTS be shorted to RTS before the DSR line is connected.

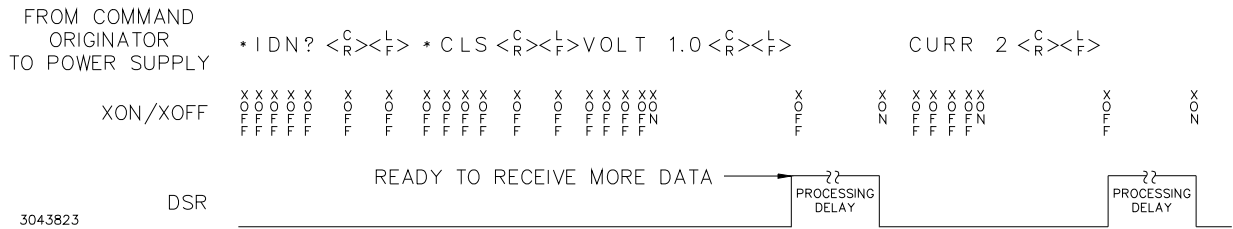

**FIGURE 3-19. RS 232 IMPLEMENTATION**

Only seven control characters (characters between 00<sub>H</sub> and 1F<sub>H</sub>) are acknowledged by the power supply:

- Carriage Return (CR, 0D<sub>H</sub>)
- Line Feed (LF, 0A<sub>H</sub>)
- Back Space (BS, 08<sub>H</sub>)
- Escape (ESC, 01B<sub>H</sub>)
- XON (011<sub>H</sub>)
- XOFF (013<sub>H</sub>)
- CAN (018<sub>H</sub>)

BS deletes the last character entered, with the exception of CR or LF characters. Either the CR or LF character acts as the line terminator, initiating parsing of the ASCII data sent to the BOP by the command originator. When the line is parsed and the commands are sent to the analog processor, the BOP sends the line terminator sequence CR LF to the command originator.

The ESC character is used for synchronization, causing the BOP to reset its input buffer and return a CR LF sequence.

The XON character enables the transmitter if XON/XOFF flow control is enabled (see PAR. 3.5.3.3.2 and Table 3-17).

The XOFF character stops data transmission if XON/XOFF flow control is enabled (see PAR. 3.5.3.3.2 and Table 3-17).

The CAN character resets the receive and transmit pointers and queues.



**CAUTION:** When the serial port has received an XOFF, the error message “-400, Query Error” will be placed in the queue to indicate the loss of transmitted information due to a received XOFF character. When XON is received, the unit will transmit all data in it's buffer followed by the exclamation character (!). This (!) character is not part of any message from the BOP and indicates the transmission buffer has been cleared and the BOP is idle.

All non-control characters are sent via the serial port of the command originator. The control character BS is echoed as BS Space BS. Only the first control character is returned in response to either a CR LF or LF CR character sequence (see Figure 3-19).

### 3.5.6.2.1 XON XOFF METHOD

The XON XOFF method allows the BOP to control when the command originator is allowed to send data. The command originator can only send data after the XON (transmission on) character (011<sub>H</sub>) has been received; the command originator stops sending data after receiving the XOFF (transmission off) character (013<sub>H</sub>), and waits until the XON character is received before sending additional data.

Control characters, either CR or LF, are returned as XOFF CR if echo mode is on, and as XOFF if echo mode is off. XOFF stops data from the command originator and the BOP returns the normal sequence of CR LF (if echo mode is enabled).

### 3.5.6.2.2 ECHO MODE

Echo mode is one method of ensuring data is transferred without errors. This mode should only be enabled when errors in operation are detected.

Each byte (character) is echoed back to the sender where it is verified as the same character that was just sent. If the wrong character is echoed back, sending the ESC character clears the line to allow retransmission of the character. It is important the CR and LF characters are NOT sent until the verification process is complete.

When working in echo mode, it is possible to receive the NAK (15 hex) from the BOP. This indicates an unknown quantity of echoed characters have been lost due to a queue overflow problem. The error queue will also contain the *-400, QUE error* message. To prevent this, please ensure the received data string does not exceed 127 characters between line terminators and no more than four queries are sent between line terminators in SCPI mode of operation

All non-control characters are sent via the serial port of the command originator.

### 3.5.6.2.3 PROMPT METHOD

The command originator sends a message line (command) to the BOP and waits until the prompt sequence CR LF > (3E<sub>H</sub>, 62<sub>10</sub>) is received. The BOP sends the prompt sequence CR LF > to the command originator indicating the power supply is ready to receive the next command and data will not be lost. This method is useful in an interactive mode as well as with certain process controllers.





### 3.5.6.3 USING SCPI COMMANDS FOR RS 232 COMMUNICATION.

The unit will automatically go into remote mode for each command received.



### 3.5.6.4 ISOLATING RS 232 COMMUNICATION PROBLEMS

A Loop Back test can be run from the front panel to aid in isolating RS 232 communication problems. The unit is designed to pass the test only with the Loop Back test connector (part of Kit 219-0436, see Table 1-4) installed.

1. From the power-up screen press  key to enter the General Setup menu, then highlight Revisions/TEST. press  to enter the Test Subsystem menu.
2. Highlight Serial and press  to run the test with the Loop Back Test connector NOT installed and verify the LCD reads **Failed**. If the LCD reads **Passed**, the power supply is defective and requires repair.
3. Install the loop back test connector into RS 232 port and press the  key to rerun the test. If the LCD reads **Passed**, the power supply is operating properly. If the LCD reads **Failed**, the unit requires repair.
4. To test the integrity of the cable assembly connecting the power supply RS 232 port to the computer, remove the Loop Back test connector from the power supply RS 232 port and connect the cable in its place. With the DB9 adapter installed on the opposite end of the cable, connect a short jumper wire between pins 2 and 3 of the adapter connector and repeat the test of step 3 above. If the LCD display reads **Failed**, the cord is either the improper type (not null modem) or is defective. If the LCD display reads **Passed**, the cable is correct; remove the jumper and reconnect the cable to the computer.

If each of the above steps is completed successfully, the problem lies in the computer hardware and/or software. Refer to the Product Support area of the Kepco website for additional information regarding RS 232 communications problems: [www.kepcopower.com/support](http://www.kepcopower.com/support).

### 3.5.7 LAN OPERATION (ME MODELS ONLY)

Once the LAN interface is properly installed (see PAR. 2.7.6) and configured (see PAR. 3.5.3.4), BOP (ME Models) can be operated from a remote location using the LAN interface via a web browser as described in the following paragraphs.

#### 3.5.7.1 LAN FACTORY DEFAULTS

The factory default LAN interface settings are listed below, however, actual unit settings may differ from those shown below depending upon whether the LAN is active (or connected).

- DHCP: ON
- AUTOIP: ON
- PING: ON (can only be changed through web interface)
- IP Address: Undefined
- MASK Address: 255.255.255.0
- GATE Address: 0.0.0.0
- DNS Address: 0.0.0.0

These default setting can be restored using the LAN Reset button (see Figure 2-1) or configured as desired from the web interface (see PAR. 3.5.7.2).

If the LAN connection is active when the LAN Reset button is pressed, the default values are as shown above, except that IP, MASK, GATE and DNS addresses are retrieved from the LAN or router and may differ from values shown

### 3.5.7.2 REMOTE PROGRAMMING USING THE WEB INTERFACE

Remote programming of the BOP 2KW-ME via the LAN port can be accomplished using a standard web browser connected to the internet. The factory default LAN settings of the BOP 2KW-ME are DHCP on, AUTOIP on. When source power is applied to the power supply (e.g., circuit breaker switched on), it first tries to find a DHCP server and get an IP address; during this time the LAN indicator on the rear panel continues to blink. If a server is found and an address assigned, the LAN indicator stays on without blinking.

If the server is not found after approximately 10 seconds, a duplicate address is supplied by the DHCP, however if DHCP has been disabled, the unit will use AUTOIP to get an address. If an IP address is found, the LAN indicator on the rear panel stays on without blinking. The range of valid AUTOIP addresses is 169.254.000.000 through 169.254.254.255 inclusive. Note that the Network Mask default for AUTOIP is 255.255.000.000. If an IP address is not found after two seconds, the LAN indicator stays off.

### 3.5.7.3 TROUBLESHOOTING LAN COMMUNICATION PROBLEMS.

**If the LAN indicator stays off:**

- First verify that the host end of the LAN connection is active (switch or hub is powered on). These devices typically include indicators that indicate port activity, so if the port to which the power supply is connected is inactive (dark), try connecting to a different port.
- Inspect the LAN cable connections at both ends, ensuring that the plugs are fully engaged with their respective receptacles. Try replacing the LAN cable with a cable known to be good.
- Verify that regardless whether the BOP 2KW-ME is connected directly to the computer's LAN port or through a switch hub or router, the connection **is NOT made using a null modem (crossover) cable** that reverses the transmit and receive pairs. The BOP 2KW-ME is Auto-MDI-X enabled and does not require a crossover cable for direct connection.

**If the LAN indicator is on without blinking, but communication problems persist:**

- The cause may be a fixed address on the PC that is incompatible with the AUTOIP range (169.254.xxx.xxx) of the BOP 2KW-ME. Refer to PAR. 2.7.6.1 to find the BOP 2KW-ME on the LAN, then refer to PAR. 3.5.7.2 and launch the web interface to correct the address.
- Refer to PAR 3.5.7.4 for browser types and versions supported and settings required.

- There can be latent delays in establishing communication between various devices on the LAN network hub, especially when the devices are powered on asynchronously. As a result, a steady LAN indication may begin blinking again when another device or the host computer itself is subsequently powered on. While this is a normal occurrence that typically resolves itself within a few seconds, LAN communication is interrupted during that time. Should this occur, first activate all devices connected to the hub and wait until the BOP 2KW-ME rear panel LAN indicator is on steadily for several seconds before attempting to communicate with the BOP 2KW-ME.

#### **3.5.7.4 LAUNCH WEB INTERFACE**

After finding the unit and selecting the desired unit on the LAN (see PAR. 2.7.6.1), click the Launch Webpage button to open the BOP 2KW-ME Instrument HOME PAGE (UNIT DESCRIPTION) in your default browser (see Figure 3-20). You can also launch the web page in any browser by entering the IP address as the URL.

**NOTE:** If source power to the BOP 2KW-ME is removed or lost while a browser window is open, communication with the BOP 2KW-ME cannot be restored until the present browser window is closed and a new window is opened.

Upon initial display of the web page, it is good practice to click the browser Refresh/Reload button once to ensure that the power supply information displayed is up to date, and not prior information recalled from the browser cache.

Although most current browsers will work, Kepco recommends the following as fully supported: Safari, IE 8.0 and higher and Firefox 1.0 and higher. Popup blocking must be disabled and Javascript must be enabled for proper operation. If popup blocking is enabled, it may prevent viewing of the help screens.

The BOP 2KW-ME Instrument Home page identifies the unit which has been accessed, including Manufacturer, Instrument, Description, LXI Version (1.4), Serial Number, Calibration Date, Hostname, MAC Address, LAN Firmware Revision and VISA Address String. Click the HELP box at the left of the screen for detailed explanations of each. These parameters can not be changed by the user. The hostname ends with .LOCAL if the MDNS has been completely resolved. This feature allows for easy discovery through the MDNS or Bonjour common naming system.

When using the unit with Kepco drivers, the user must add a 0 (or other number) to the VISA address string to represent the actual TCPIP connection on the computer. For example TCPIP0::192.168.1.111::5025::SOCKET is the correct VISA resource string to use with Kepco drivers. In NiMax this is a Raw Socket address string if using this tool to configure VISA resources.

Clicking the ID INSTRUMENT box at the left of the screen, causes the physical LAN indicator on the rear panel of the selected unit to blink (see Figure 2-1), allowing visual confirmation as to which unit is selected. This is especially important if more than one unit is found on the LAN.

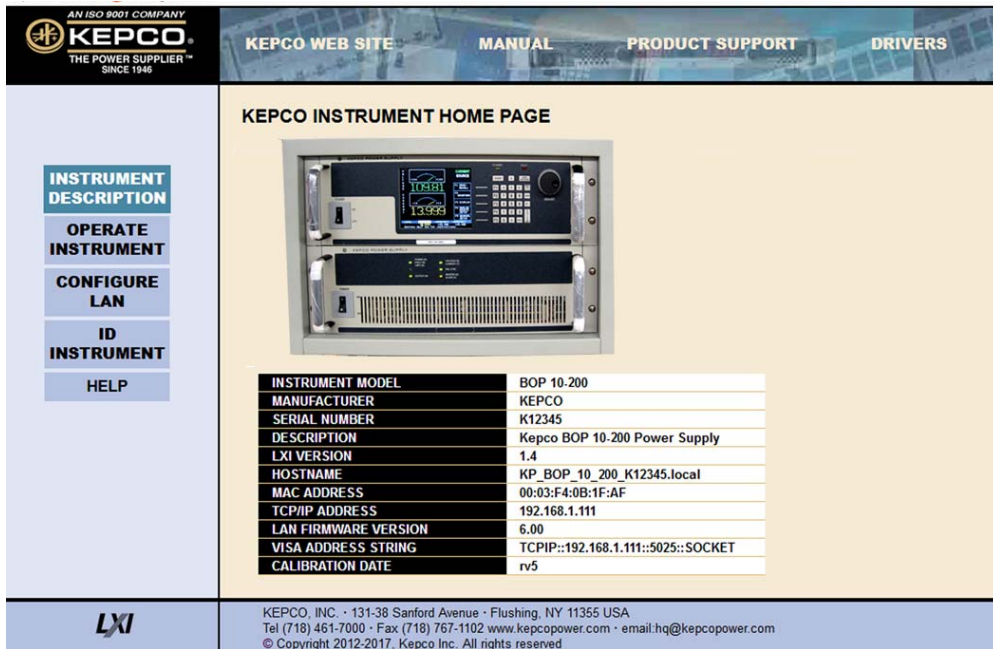

FIGURE 3-20. WEB INTERFACE HOME PAGE (UNIT DESCRIPTION)

### 3.5.7.5 LAN CONFIGURATION USING WEB INTERFACE

From the Web Interface Home Page (Figure 3-20) click on CONFIGURE LAN at the left to view the LAN Configuration page (Figure 3-21). The parameters that can be configured from this page are Host Name (DHCP), Description, IP Address, Subnet Mask address, Default Gateway Address, and DNS Server Address. Separate check-boxes allow enabling of DHCP, AUTOIP and PING. Descriptions of these terms can be viewed by clicking the HELP box at the left. If a data entry fault condition exists, an alert window indicates the type of fault. Click OK to close the window; the SUBMIT button is disabled until the fault is corrected.

There are three passwords shown on this page which control access to the web pages only. All three web passwords described below are case sensitive.

NOTE: In cases where multiple users are expected to have access to the units, it is recommended that password access be used to restrict *control* of the unit to one user (functioning as a bus controller), while allowing other users viewing access. Allowing multiple users to issue commands to a single unit can cause unpredictable results and may cause the unit to lock up.

- The OPERATE INSTRUMENT password restricts the ability to modify the OPERATE INSTRUMENT page settings. The settings can still be viewed while password protected
- The CONFIGURE LAN password restricts the ability to change the LAN configuration parameters shown on the CONFIGURE LAN page (Figure 3-21.)

HOST NAME (DHCP)	KP_BOP_10_200_K12345		
DESCRIPTION	Kepco BOP 10-200 Power Supply		
IP ADDRESS	192.168.1.111	<input checked="" type="checkbox"/> DHCP ENABLED	
SUBNET MASK	255.255.255.0	<input checked="" type="checkbox"/> AUTOIP ENABLED	
DEFAULT GATEWAY	192.168.1.10	<input checked="" type="checkbox"/> PING ENABLED	
DNS SERVER	8.8.8.8		

CHANGE PASSWORD	CURRENT	NEW	REPEAT
OPERATE INSTRUMENT			
CONFIGURE LAN			

KEPCO, INC. · 131-38 Sanford Avenue · Flushing, NY 11355 USA  
 Tel (718) 461-7000 · Fax (718) 767-1102 www.kepcopower.com · email:hq@kepcopower.com  
 © Copyright 2012-2017, Kepco Inc. All rights reserved

**FIGURE 3-21. WEB INTERFACE CONFIGURE LAN PAGE**

The factory default is that passwords are not needed to access password-protected areas and none of the three passwords are established. To set a password for the first time, leave the CURRENT field blank, enter the new password in the NEW and REPEAT fields, then click SUBMIT. Subsequent changes require the current password to be entered in the CURRENT field. If a password is lost or forgotten, the factory default state (no password required) can be restored by pressing the LAN Reset button on the rear panel of the BOP 2KW-ME (see Figure 2-1).

To change a parameter, enter the correct data and/or click the appropriate check-boxes, then click SUBMIT to save the change or NO CHANGE to clear and reload the page without saving. If the data is not entered within 20 seconds after the last keystroke, the data will revert to the previous value. If the LAN CONFIGURATION password was set, you will be prompted to enter the password before the changes are accepted.

When SUBMIT is clicked after new IP address information is entered, the front panel LAN indicator blinks rapidly while the unit validates the IP address. If the address is valid, the browser returns to the INSTRUMENT HOME page (Figure 3-20). If the address entered is already in use, the following note appears towards the top of the page:

NOTE: IP Address is in use.  
 Click CONFIGURE LAN and choose another IP to correct.

An IP address that is not already in use must be entered and submitted, otherwise the browser will lock, requiring the browser to be closed and reopened.

### 3.5.7.6 OPERATING THE UNIT USING WEB INTERFACE

To operate the unit, click the OPERATE INSTRUMENT box at the left. A simulated front panel (see Figure 3-22) at the top of the screen shows 1) output voltage and current, 2) VOLT or CURR is displayed above the MODE button to indicate whether the unit is in voltage or current mode, respectively (\*\* is displayed if state is unknown, web page will update within 10 seconds), and 3) whether the output is on or off. An ON/OFF button can be clicked to turn the output on or off. The MODE button allows the user to change the BOP 2KW-ME operating mode (voltage or current).

A small white “~” to the left of the voltage display flashes to indicate the web page is communicating with the unit. If a fault condition exists, an alert window indicates the type of fault, and operation via the web is disabled. When the fault is corrected, click OK to close the alert window and resume operation via the web.

NOTE: If the OPERATE INSTRUMENT password has been set (see PAR. 3.5.7.5), you will be prompted to enter the password before the OPERATE INSTRUMENT page settings can be changed.

The functions that the user can modify are listed on the black menu bar below the representation of the front panel: Output, Reset and Waveform, and are described in the following paragraphs.

NOTE: Once data in a field has been changed, clicking the browser’s BACK button will cause all fields to revert to their previous values.

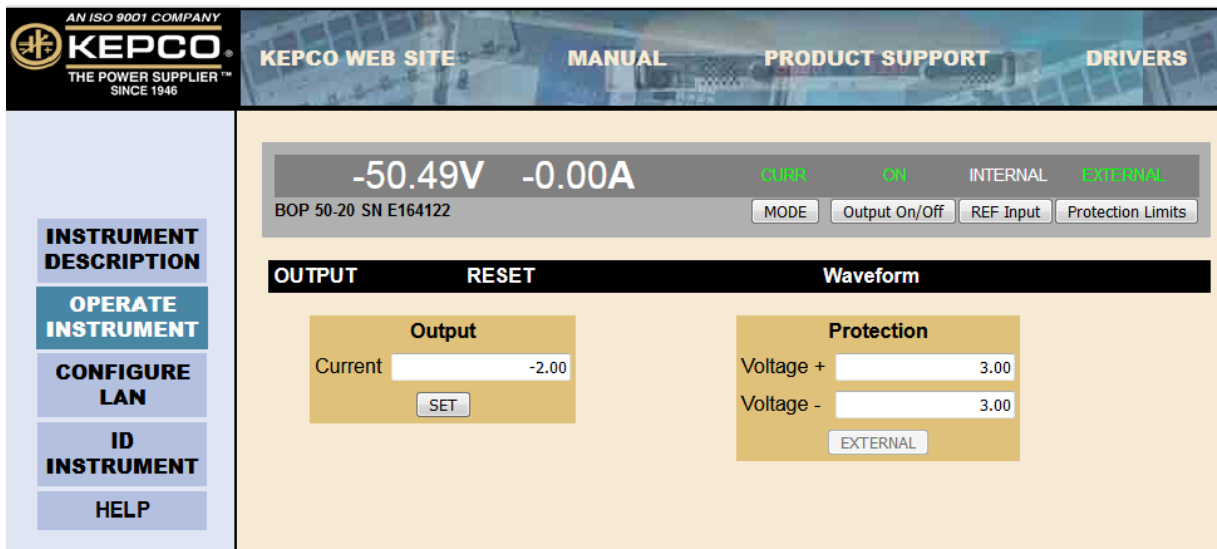

FIGURE 3-22. WEB INTERFACE OPERATE INSTRUMENT PAGE

#### 3.5.7.6.1 CHANGING THE OUTPUT

The Output dialog box opens when the OPERATE INSTRUMENT page is first opened, or when **OUTPUT** is clicked (see Figure 3-22). The default for setting output voltage or current and the corresponding protection limits is to use INTERNAL reference levels as shown on the indicators above the **Ref Input** and **Protection Limits** buttons on the simulated front panel. When in voltage mode, fields for setting output voltage and  $\pm$ current protection values are displayed as

shown in Figure 3-22. When in current mode, fields for setting output current and  $\pm$ voltage protection values are displayed. To set output voltage or current and the corresponding protection values, enter the values and click **SET**. Voltage and current settings are not allowed to exceed the model setting. Attempts to set voltage or current beyond these limits will not be accepted. To turn the output on or off, click the **Output On/Off** button within the simulated front panel.

The **Ref Input** button allows selection of either an INTERNAL or EXTERNAL reference level to control the main channel output. When **Ref Input** is set to EXTERNAL, the unit uses an external reference to change the main channel, whether voltage or current. For example, in voltage mode a  $\pm 10V$  reference applied to analog port pin 11 (referenced to pin 10) produces  $\pm E_O$  (rated). When **Ref Input** is set to EXTERNAL, the Output **SET** button changes to **EXTERNAL** to indicate that the output is controlled by an external reference can not be set from the simulated front panel. See PAR. 3.4.4.1 for more information.

The **Protection Limits** button allows selection of either INTERNAL or EXTERNAL reference levels to control the protection limits. When **Protection Limits** is set to EXTERNAL, the unit uses external +1V to +10V reference levels applied to analog port pins 5, 6, 13 and 14, referenced to pin 12 to set the protection limits (see PAR. 3.4.5 for details). When **Protection Limits** is set to EXTERNAL, the Protection **SET** button changes to **EXTERNAL** to indicate that the protection limits are controlled by external references applied to the analog port and can not be set from the simulated front panel.

### 3.5.7.6.2 RESETTING THE UNIT (\*RST)

Click **RESET** to open the Reset dialog box, then click **\*RST** button to reset power supply to the power on default state: setpoints to zero Volts and minimum Amperes, and output set to OFF. **\*RST** also clears all LIST entries.

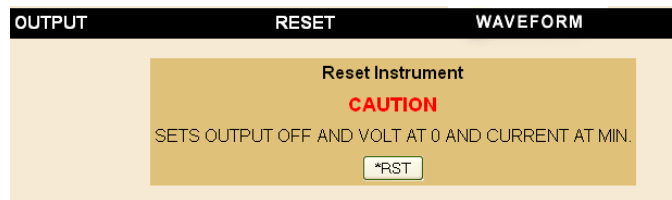

FIGURE 3-23. RESET DIALOG BOX

### 3.5.7.6.3 USING A WAVEFORM (USER-PROGRAMMED SEQUENCES)

The Waveform feature uses preconfigured LIST commands, along with up to 1000 locations which are available for programming the BOP 2KW-ME output. These locations enable the user to program the output using sequential steps which may be initiated by a single command. The repeatable user-determined sequences are stored in volatile memory and are retained until reprogrammed, the power supply is turned off, operating mode (voltage or current) is changed, a calibration is performed, or a **LIST:CLEAr** command is received.

**Create the Waveform.** Click **Waveform** to open the Waveform dialog box (Figure 3-24). Depending on the operating mode selected, either the voltage waveform or current waveform dialog box will be displayed. Click the **MODE** button at the top of the screen to change the mode. Each dialog box defines the values for one segment:

1. Enter **Wave Type** using the following codes:
 

0	Sine
1	Triangle
2	Square
3	Level
4	Positive Ramp
5	Negative Ramp
2. Enter **Wave Offset** (optional) and **Wave amplitude** in Volts or Amps, as applicable
3. Enter **Wave Frequency** (Hz).
4. Click **Generate Wave Segment** button to add a segment (the information displayed in the Voltage or Current dialog boxes). Repeat steps 1 through 3 above to add additional segments as desired.
5. When all the segments have been completed, enter the **Loop** number to specify how many times the waveform will run. A 0 means the waveform will run continuously until the **Stop Execution** button is clicked.

**Execute the Waveform.** Click the **Execute Wave** button to run the waveform.

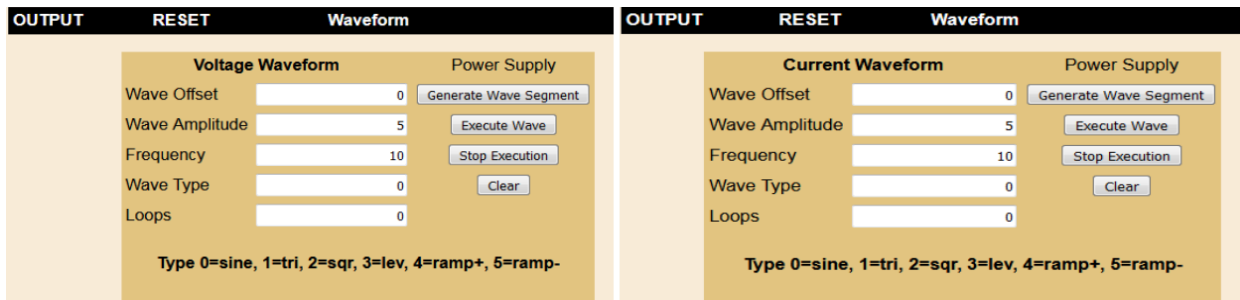

**FIGURE 3-24. WAVEFORM DIALOG BOX**

**Clearing the Waveform.** Once a Waveform has been generated, the individual segments can not be changed; the only option is to delete the waveform by pressing the **Clear** button to start over. In addition, performing any of the following operations will also clear the waveform: changing overcurrent or overvoltage PROTECTION settings, unit RESET, changing LIMIT MODEL settings and exiting the OPERATE INSTRUMENT page.

**Stop the Waveform.** After repeating the waveform as specified by the **Loop** number the waveform stops automatically with the output on, and the voltage and current at the values specified by the last segment. If the **Loop** number is 0, click the **Stop Execution** button to stop the list. When **Stop Execution** is clicked, the output stays on with the voltage and current at the values in effect prior to the stop command. If the **Execute Waveform** button is clicked again, the waveform restarts from the beginning. If the waveform is stopped by clicking the **CLEAR** button, the output turns off and **Output** setpoints are reset to 0V, minimum current.



## **3.6 SCPI PROGRAMMING**

SCPI (Standard Commands for Programmable Instruments) is a programming language conforming to the protocols and standards established by IEEE 488.2 (reference document *ANSI/IEEE Std 488.2, IEEE Standard Codes, Formats, Protocols, and Common Commands*). SCPI commands are sent to the BOP Power Supply as ASCII output strings within the selected programming language (PASCAL, BASIC, etc.) in accordance with the manufacturer's requirements for the particular GPIB controller card used.

Different programming languages (e.g., BASIC, C, PASCAL, etc.) have different ways of representing data that is to be put on the IEEE 488 bus. It is up to the programmer to determine how to output the character sequence required for the programming language used. Address information (GPIB address) must be included before the command sequence. (See PAR.3.5.3.2.1 to establish the BOP Power Supply GPIB address.)

### **3.6.1 SCPI MESSAGES**

There are two kinds of SCPI messages: program messages from controller to power supply, and response messages from the power supply to the controller. Program messages consist of one or more properly formatted commands/queries and instruct the power supply to perform an action; the controller may send a program message at any time. Response messages consist of formatted data; the data can contain information regarding operating parameters, power supply state, status, or error conditions.

### **3.6.2 COMMON COMMANDS/QUERIES**

Common commands and queries are defined by the IEEE 488.2 standard to perform overall power supply functions (such as identification, status, or synchronization) unrelated to specific power supply operation (such as setting voltage/current). Common commands and queries are preceded by an asterisk (\*) and are defined and explained in Appendix A (see Table 4-4). Refer also to syntax considerations (PARs 3.4.3 through 3.4.6).

### **3.6.3 SCPI SUBSYSTEM COMMAND/QUERY STRUCTURE**

Subsystem commands/queries are related to specific power supply functions (such as setting output voltage, current limit, etc.) Figure 3-25 is a tree diagram illustrating the structure of SCPI subsystem commands used in the BOP Power Supply with the "root" at the left side, and specific commands forming the branches. The following paragraphs introduce the subsystems; subsystem commands are defined and explained in Appendix B.

#### **3.6.3.1 ABORT SUBSYSTEM**

This subsystem allows pending trigger levels to be cancelled.

#### **3.6.3.2 INITIATE SUBSYSTEM**

This subsystem enables the trigger system. When a trigger is enabled, the triggering action will occur upon receipt of a GPIB <GET>, \*TRG or TRIGger command. If a trigger circuit is not enabled, all trigger commands are ignored.

### **3.6.3.3 LIST SUBSYSTEM**

The LIST subsystem allows the BOP to generate complex waveforms by executing a series of points in order. Each point contains a value for the main channel (either voltage or current) and the duration (dwell) that the value will appear at the output (from 93  $\mu$ S to 0.034 Second. The list system supports from 2950 to 5900 points per waveform, depending on the number of different dwells in the waveform: For example, if each point in the list has the same duration (a single dwell time), 5900 points are supported; if no more than 122 different dwell times are specified, 3933 points are supported, and if each point has a different dwell, a maximum of 2950 points are supported. The number of points supported is determined automatically by the BOP firmware.

The LIST subsystem includes a subsystem for waveform generation. The waveform generation is invoked with the verb APPLY. When APPLY is added to a list:volt or list:curr command, the BOP adds a series of points to the list arrays. The BOP can apply these points to approximate a SINE, Triangle, RAMP (positive or negative) or square waveform or a level. The basic command requires a type, frequency (or period for a level), a peak-to-peak amplitude (or amplitude for a level), and offset (offset not needed for a level) The unit will create an appropriate number of points in both the dwell and output control array to create the waveform centered on zero volts. An optional offset can be added to the command to cause the BOP to generate a non-centered waveform. For example, a 5 volt 400 Hertz sine wave may be centered at -3 volts. The list subsystem has controls the allow the user to modify the unit's behavior to generate parts of waveforms and to used specific dwell times as appropriate. The APPLY subsystem accommodates 122 different segments in a single waveform provided the generated points fit in the array. See paragraph 3.3.10.3 for an explanation of how a waveform is generated by the BOP.

### **3.6.3.4 MEASURE SUBSYSTEM**

This query subsystem returns the voltage and current measured at the power supply's output terminals. Commands are provided to coordinate the rate and sequencing of the Measurement System with Output System updates.

### **3.6.3.5 OUTPUT SUBSYSTEM**

This subsystem controls the power supply's voltage and current outputs.

ROOT : (colon)

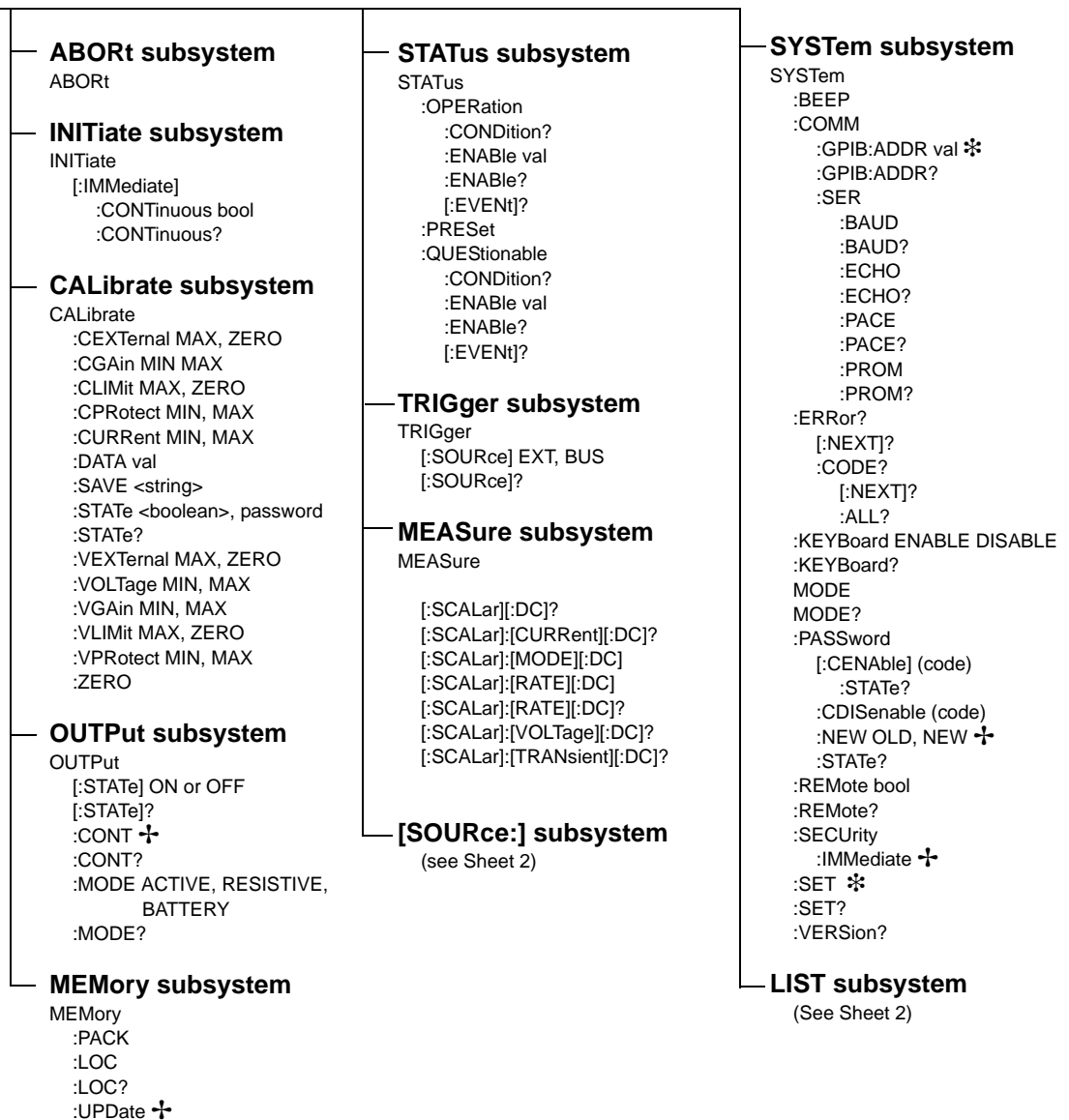

† See PAR. 3.5.2.2 and Figure 3-18 for special programming considerations.

‡ Requires MEM:UPD to save for power-up.

FIGURE 3-25. TREE DIAGRAM OF SCPI COMMANDS USED WITH BOP POWER SUPPLY (SHEET 1 OF 2)

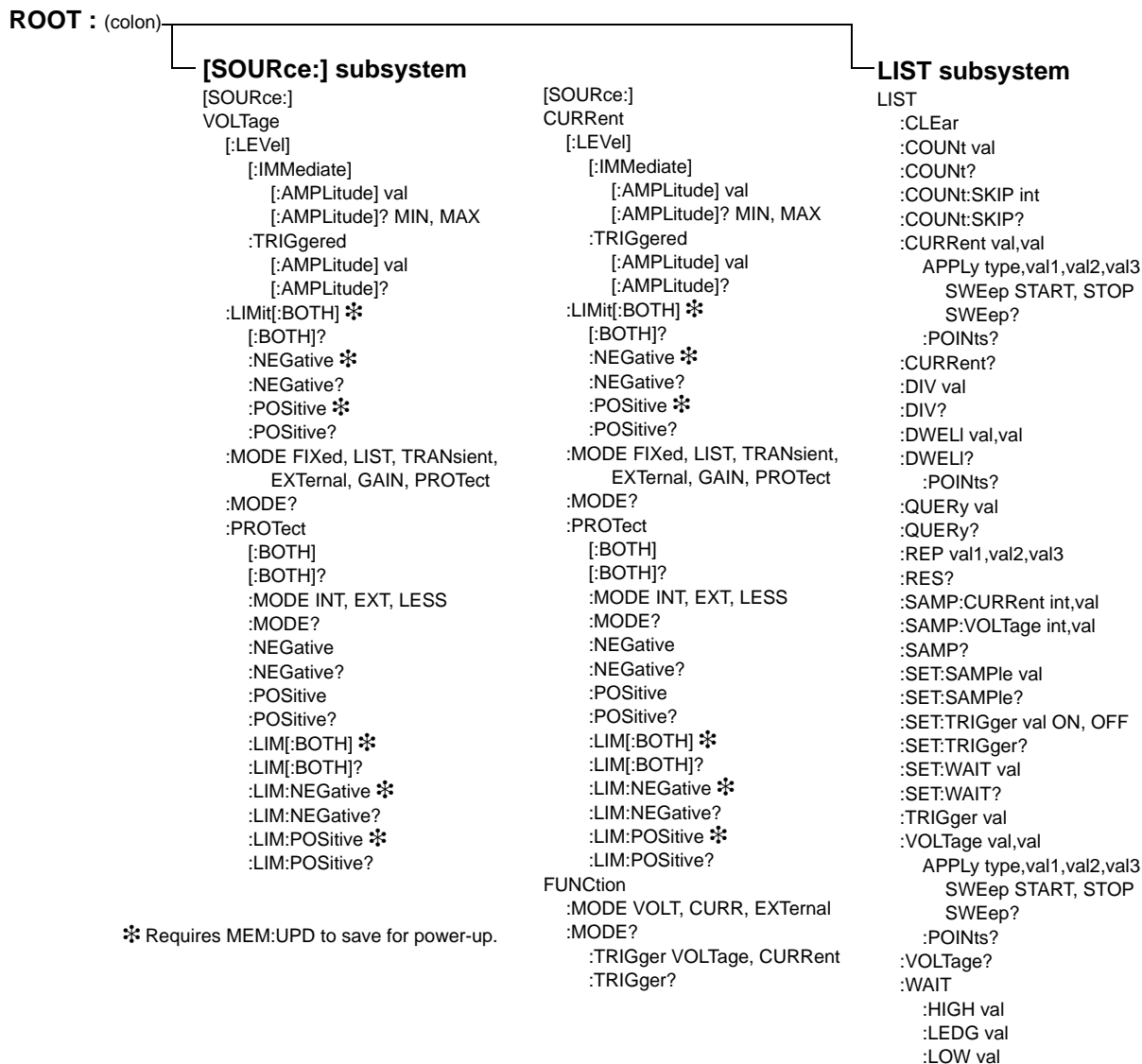

**FIGURE 3-25. TREE DIAGRAM OF SCPI COMMANDS USED WITH BOP POWER SUPPLY (SHEET 2 OF 2)**

### 3.6.3.6 MEMORY SUBSYSTEM

This subsystem controls the Flash Memory used by the BOP microprocessors and is used for storing setup parameters and for storing a list for later recall and execution.

The unit's configuration, voltage and current, saved setups (\*SAV and \*RCL command) and Calibration values are stored in Flash Memory. Since the Flash EEPROM cannot be modified by writing a single data byte, the block must be erased and then the data written into the correct locations.

Saved setups are accomplished by the 99 memory locations (groups of settings) which are stored in the nonvolatile memory. Each setting contains values for: Mode, main channel setting (voltage or current), Reference setting, positive and negative protect values, External Protect setting (see Table 3-19), and the keypad state (locked/unlocked. If the keypad is locked (SYST:KEYB DISable), the \*SAV command creates a protected setting that can not be altered from the front panel.

The BOP accomplishes this by partitioning the Flash memory. As the amount of Flash memory used becomes larger with each subsequent data update, the Flash memory fills up and needs to be compressed. The compression of the Flash EEPROM, called packing, is automatically handled by the BOP microprocessor's code. The packing process can take a half a Second to accomplish. Because it is automatically executed, it can occur after any \*SAV or save of Calibration. When the memory is out of space, the internal microprocessor moves any data in the first page to the end of the flash array and then erases the first flash page. The pack process can take 500 mS to complete. Packing is automatically invoked during power up initialization if the BOP finds that any storage area is over 90% utilized. If the memory is over 20% full, the user can also initiate packing by sending the command MEMory:PACK. Issuing a MEMory:PACK command if the memory is less than 20% full will have no effect. Refer to paragraph 3.5.2.2 for programming considerations when working with the memory system of the BOP.

The following statistics are a guide as to when a MEMORY PACK will occur.

- Save area - Approximately 300 \*SAV operations can be completed before a PACK will occur automatically.
- Variable area - around 3000 updates can be completed prior to an automatic PACK occurring. Variable areas also include serial number updates and password updates.
- Calibration - 64 calibrations can be saved before a PACK is required.

### **3.6.3.7 STATUS SUBSYSTEM**

This subsystem programs the power supply status register. The power supply has two groups of status registers: Operation and Questionable. Each group consists of three registers: Condition, Enable, and Event.

### **3.6.3.8 TRIGGER SUBSYSTEM**

This subsystem controls the remote triggering of the power supply.

### **3.6.3.9 [SOURCE:]VOLTAGE AND [SOURCE:]CURRENT SUBSYSTEMS**

These subsystems program the output voltage and current of the power supply.

### 3.6.3.10 CALIBRATE SUBSYSTEM

The BOP series of power supplies support software calibration. A full calibration consist of a voltage calibration and a current calibration. These calibration procedures include steps that prepare the unit for series or parallel operation. Both voltage and current calibrations consist of a zero (performed on the main channels only) and positive and negative full scale calibrations with both internal and external references. In addition, the external reference and variable gain are also calibrated. There are two ways to perform the calibration: locally using the front panel keys, or remotely sending commands through the GPIB bus. These two ways cannot be combined.

In order to enter the calibration mode the correct calibration access code (password) must be entered. If the password has been forgotten call the factory and a secret password (which has been assigned to your power supply) will be provided. During the calibration, new calibration data is computed which is than stored in the non volatile memory.

Refer to PAR. 4.2 for calibration equipment requirements.

During voltage calibration, the voltage, voltage protect and voltage readback are calibrated and during current calibration the current, current protect and current readback are calibrated. The normal procedure is to calibrate voltage first and then current. However, you do not have to do a complete calibration each time. If required, you may calibrate only the voltage or the current and then proceed to saving the calibration results. For voltage calibration all loads must be disconnected and the sense terminals connected to the corresponding output terminals. The digital voltmeter will be connected to the sensing terminals (OUT S and COM S) of the power supply. For current calibration after disconnecting all loads an appropriate shunt resistor will be connected across output terminals and the digital voltmeter will be connected across the sense terminals of the shunt resistor.

### 3.6.3.11 SYSTEM SUBSYSTEM

This subsystem controls system-level commands, including setup of the GPIB and Serial ports, error queries, front panel setup (keyboard lockout, display illumination, and audible beeps), passwords, command language, setup of device clear, line feed and reset, and restoring factory calibration.

#### 3.6.3.11.1 FORGOTTEN PASSWORDS

If a password is lost, please contact the factory.

### 3.6.4 PROGRAM MESSAGE STRUCTURE

SCPI program messages (commands from controller to power supply) consist of one or more *message units* ending in a *message terminator*. The message terminator is not part of the syntax; it is defined by the way your programming language indicates the end of a line ("newline" character). Sending a character with EOL line asserted is another way of sending a message terminator. The message unit is a keyword consisting of a single command or query word followed by a message terminator (e.g., CURR?<newline> or TRIG<end-of-line>). The message unit may include a data parameter after the keyword separated by a space; the parameter is usually numeric (e.g., CURR 5<newline>), but may also be a string (e.g., OUTP ON<newline>). Figure 3-26 illustrates the message structure, showing how message units are combined. Note that SCPI syntax does not permit random spaces; only spaces dictated by the syntax are permitted. The following subparagraphs explain each component of the message structure.

NOTE: An alternative to using the message structure for multiple messages defined in the following paragraphs is to send each command as a separate line. In this case each command must use the full syntax shown in Appendix B. CALibration, DIAGnostic and LIST commands must be sent as a single program message using multiple message units.

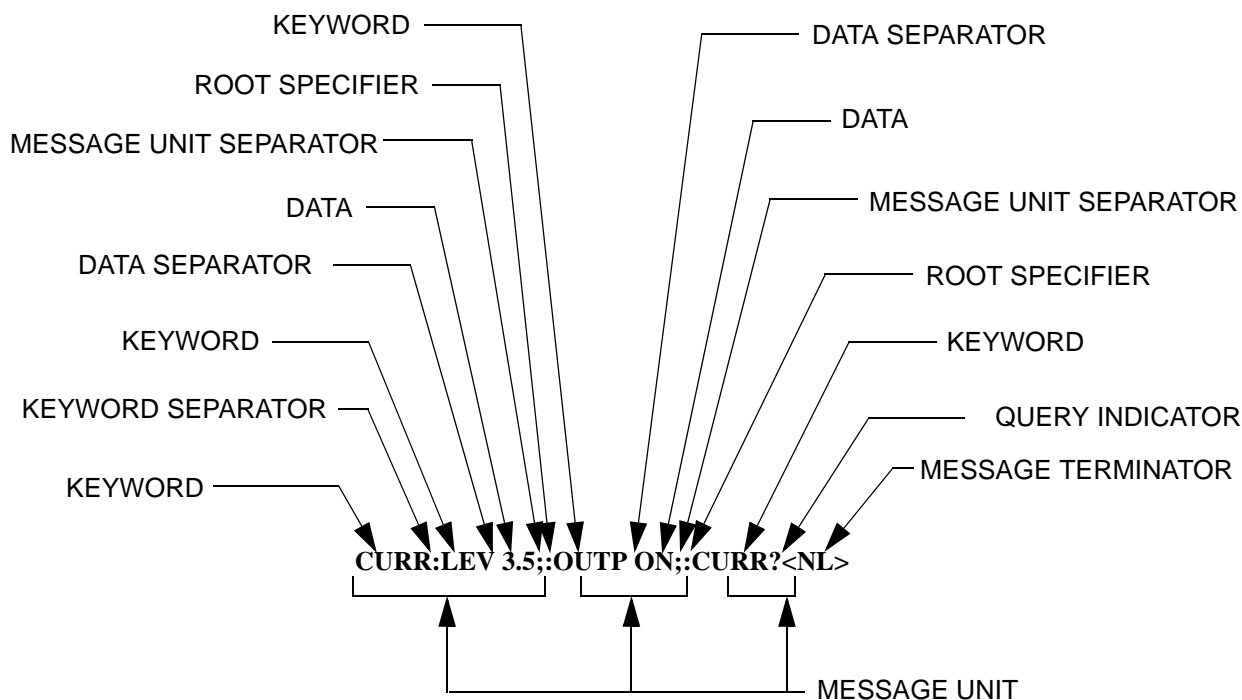

FIGURE 3-26. MESSAGE STRUCTURE

### 3.6.4.1 KEYWORD

Keywords are instructions recognized by a decoder within the BOP, referred to as a “parser.” Each keyword describes a command function; all keywords used by the BOP are listed in Figure 3-25. Keywords must end with a space, comma, semicolon, colon, question mark, or <newline>.

Each keyword has a long form and a short form. For the long form the word is spelled out completely (e.g. STATUS, OUTPUT, VOLTAGE, and TRIGGER are long form keywords). For the short form only the first three or four letters of the long form are used (e.g., STAT, VOLT, OUTP, and TRIG). The rules governing short form keywords are presented in Table 3-22. There are exceptions to the rules, where only the long form is accepted. These exceptions are documented in the Appendices as applicable.

TABLE 3-22. RULES GOVERNING SHORTFORM KEYWORDS

IF NUMBER OF LETTERS IN LONGFORM KEYWORD IS:	AND FOURTH LETTER IS A VOWEL?	THEN SHORT FORM CONSISTS OF:	EXAMPLES
4 OR FEWER	(DOES NOT MATTER)	ALL LONG FORM LETTERS	MODE

**TABLE 3-22. RULES GOVERNING SHORTFORM KEYWORDS**

5 OR MORE	NO	THE FIRST FOUR LONG FORM LETTERS	MEASure, OUTPut, EVENt
	YES	THE FIRST THREE LONG FORM LETTERS	LEVel, IMMEDIATE, ERRor

You must use the rules above when using keywords. Using an arbitrary short form such as ENABL for ENAB (ENABLE) or IMME for IMM (IMMEDIATE) will result in an error. Regardless of which form chosen, you must include all the letters required by that form.

To identify the short form and long form in this manual, keywords are written in upper case letters to represent the short form, followed by lower case letters indicating the long form (e.g., IMMEDIATE, EVENt, and OUTPut). The data pre-processor automatically converts all lower case characters received to upper case, allowing mixed case commands to be recognized (e.g., outp, OutP, OUTPUT, ouTPut, or OUTp are all valid). The pre-processor also recognizes a double-quoted string and will not convert the enclosed string to upper case. Double quotes should only be used for diagnostic commands, passwords and list names.

**3.6.4.2 KEYWORD SEPARATOR**

If a command has two or more keywords, adjacent keywords must be separated by a colon (:) which acts as the keyword separator (e.g., CURR:LEV:TRIG). The colon can also act as a root specifier (paragraph 3.6.4.7).

**3.6.4.3 QUERY INDICATOR**

The question mark (?) following a keyword is a query indicator. This changes the command into a query. If there is more than one keyword in the command, the query indicator follows the last keyword. (e.g., VOLT? and MEAS:CURR?).

**3.6.4.4 DATA**

Some commands require data to accompany the keyword either in the form of a numeric value or character string. Data always follows the last keyword of a command or query (e.g., VOLT:LEV:TRIG 14 or SOUR:VOLT? MAX. Data must end with a space, comma, semicolon, colon, question mark, or <newline>.

**3.6.4.5 DATA SEPARATOR**

Data must be separated from the last keyword by a space (e.g., VOLT:LEV:TRIG 14 or SOUR:VOLT? MAX

**3.6.4.6 MESSAGE UNIT SEPARATOR**

When two or more message units are combined in a program message, they must be separated by a semicolon (;) (e.g., VOLT 15;MEAS:VOLT? and CURR 12; CURR:TRIG 12.5).



### 3.6.4.7 ROOT SPECIFIER

The root specifier is a colon (:) that precedes the first keyword of a program message. This places the parser at the root (top left, Figure 3-25) of the command tree. Note the difference between using the colon as a keyword separator and a root specifier in the following examples:

VOLT:LEV:IMM 16 Both colons are keyword separators.

:CURR:LEV:IMM 4 The first colon is the root specifier, the other two are keyword separators.

VOLT:LEV 6;:CURR:LEV 15 The second colon is the root specifier, the first and third are keyword separators

:INIT ON;:TRIG;:MEAS:CURR?:VOLT? The first three colons are root specifiers.

### 3.6.4.8 MESSAGE TERMINATOR

The message terminator defines the end of a message. One message terminator is permitted:

- new line (<NL>), ASCII 10 (decimal) or 0A (hex)

NOTE: Kepco power supplies *require* a message terminator at the end of each program message. The examples shown in this manual assume a message terminator will be added at the end of each message. Where a message terminator is shown it is represented as <NL> regardless of the actual terminator character.

### 3.6.5 UNDERSTANDING THE COMMAND STRUCTURE

Understanding the command structure requires an understanding of the subsystem command tree illustrated in Figure 3-25. The “root” is located at the top left corner of the diagram. The parser goes to the root if:

- a message terminator is recognized by the parser
- a root specifier is recognized by the parser

*Optional keywords* are enclosed in brackets [ ] for identification; optional keywords can be omitted and the power supply will respond as if they were included in the message. The root level keyword [SOURCE] is an optional keyword. Starting at the root, there are various branches or paths corresponding to the subsystems. The root keywords for the BOP Power Supply are :ABORt, :CALibrate, :DISPlay, :INITiate, :LIST, :MEASure, :OUTPut, [:SOURCE], :STATus, :SYSTEM and :TRIGger. Because the [SOURCE] keyword is optional, the parser moves the path to the next level, so that VOLTage, CURRent, and FUNCtion commands are at the root level.

Each time the parser encounters a keyword separator, the parser moves to the next indented level of the tree diagram. As an example, the STATus branch is a root level branch that has

three sub-branches: OPERation, PRESet, and QUEStionable. The following illustrates how SCPI code is interpreted by the parser:

**STAT:PRES<NL>**

The parser returns to the root due to the message terminator.

**STAT:OPER?;PRES<NL>**

The parser moves one level in from STAT. The next command is expected at the level defined by the colon in front of OPER?. Thus you can combine the following message units STAT:OPER? and STAT:PRES;

**STAT:OPER:COND?;ENAB 16<NL>**

After the OPER:COND? message unit, the parser moves in one level from OPER, allowing the abbreviated notation for STAT:OPER:ENAB.

### 3.6.6 PROGRAM MESSAGE SYNTAX SUMMARY

- Common commands begin with an asterisk (\*).
- Queries end with a question mark (?).
- Program messages consist of a root keyword and, in some cases, one or more message units separated by a colon (:) followed by a message terminator. Several message units of a program message may be separated by a semicolon (;) without repeating the root keyword.
- If a program message has more than one message unit, then a colon (:) must precede the next keyword in order to set the parser back to the root (otherwise the next keyword will be taken as a subunit of the previous message unit).

e.g., the command **meas:volt?;curr?** will read output voltage and output current since both **volt?** and **curr?** are interpreted as subunits of the **meas** command.

- Several commands may be sent as one message; a line feed terminates the message. Commands sent together are separated by a semicolon (;). The first command in a message starts at the root, therefore a colon (:) at the beginning is not mandatory. E.g., the command **meas:volt?;curr?** will read output voltage and programmed current since the colon preceding **curr?** indicates that **curr?** is not part of the **meas** command and starts at the root.
- UPPER case letters in mnemonics are mandatory (short form). Lower case letters may either be omitted, or must be specified completely (long form)  
e.g., **INSTrument** (long form) has the same effect as **INST** (short form).

- Commands/queries may be given in upper/lower case (long form) e.g., **SoUrCe** is allowed.
- Text shown between brackets [ ] is optional. e.g., **:[SOUR]VOLT:[LEV] TRIG** has the same effect as **:VOLT TRIG**

### 3.6.7 STATUS REPORTING

The status reporting of the BOP power supply follows the SCPI and IEEE 488.2 requirements. The serial poll response of the BOP power supply provides summary bits of the status and error reporting system. The simplest status report is the command valid reporting and data availability. The successful decoding of a command string generates no error and is indicated by the bit 3 of the serial poll response being a zero. The setting of bit 4 in the status byte indicates data is available to the controller in response to a command query message.

#### 3.6.7.1 STATUS REPORTING STRUCTURE

The status reporting of the BOP uses four status registers, illustrated in Figure 3-27. These registers are the Questionable, Operation, Standard Event Status and Status Byte registers. The Questionable and Operation registers are 16 bit registers and the Standard Event Status and Status Byte registers are 8 bits. These four registers are referred to as condition registers. Each of the four condition registers is associated with two related registers: an event register which holds unlatched events reported in real-time by the instrument and is cleared by reading the register, and an enable register which allows the contents of the event register to be passed through to set the associated condition register.

A zero to one transition of a condition register is added to the event register. Reading an event register clears all of the bits found in the event register. If any bits are set in an event register, the following condition register bit is then set. For example, if the STAT:QUES:ENB (enable) register has bit 0 set and a voltage error is detected, the event registers bit 0 is set. The 1 in the event register causes bit 3 of the status byte to be asserted. The Status Byte register is ANDed with the Service Request Enable register for all bits except bit 6. The result is placed in bit 6 of the Service Request register. If bit 6 is a 1 (true), it causes the power supply to assert the SRQ line to the host controller.

Figure 3-27 also shows that if the error/event queue is not empty, bit 3 is set in the Service Request register and bit 4 indicates that a message is available in the output buffer.

#### 3.6.7.2 OPERATIONAL STATUS REGISTER

The OPERational condition register contains conditions which are a part of the instrument's normal operation. The definition of each of these bits (condition register) is as follows:

- 0 - Not Used — always zero.
- 1 - Settling — 1 indicates Measurement System is changing and MEAS commands are less accurate (see PAR. 3.5.1.1).
- 2 through 4 - Not Used — always zero.
- 5 - Waiting for Trigger — 1 indicates the trigger system is enabled. If trigger source is external and the trigger input goes low, the WTG will remain in a one condition until after the trigger input goes high.
- 6 - Transient Armed — 1 indicates the transient function is enabled,

- 7 - Not Used — always zero.
- 8 - Constant Voltage — 1 indicates the instrument is in constant voltage mode.
- 9 - Transient Complete — 1 indicates transient has been completed. Not readable in OPERATION Status Condition register.
- 10 - Constant Current — 1 indicates the instrument is in constant current mode.
- 11 - Sample Complete — 1 indicates the sample has been completed.
- 12 - List Complete — 1 indicates the programmed list has been completed. Not readable in OPERATION Status Condition register.
- 13 - Not Used — always zero.
- 14 - List Running — 1 indicates the programmed list is in progress.
- 15 - Not Used — always zero.

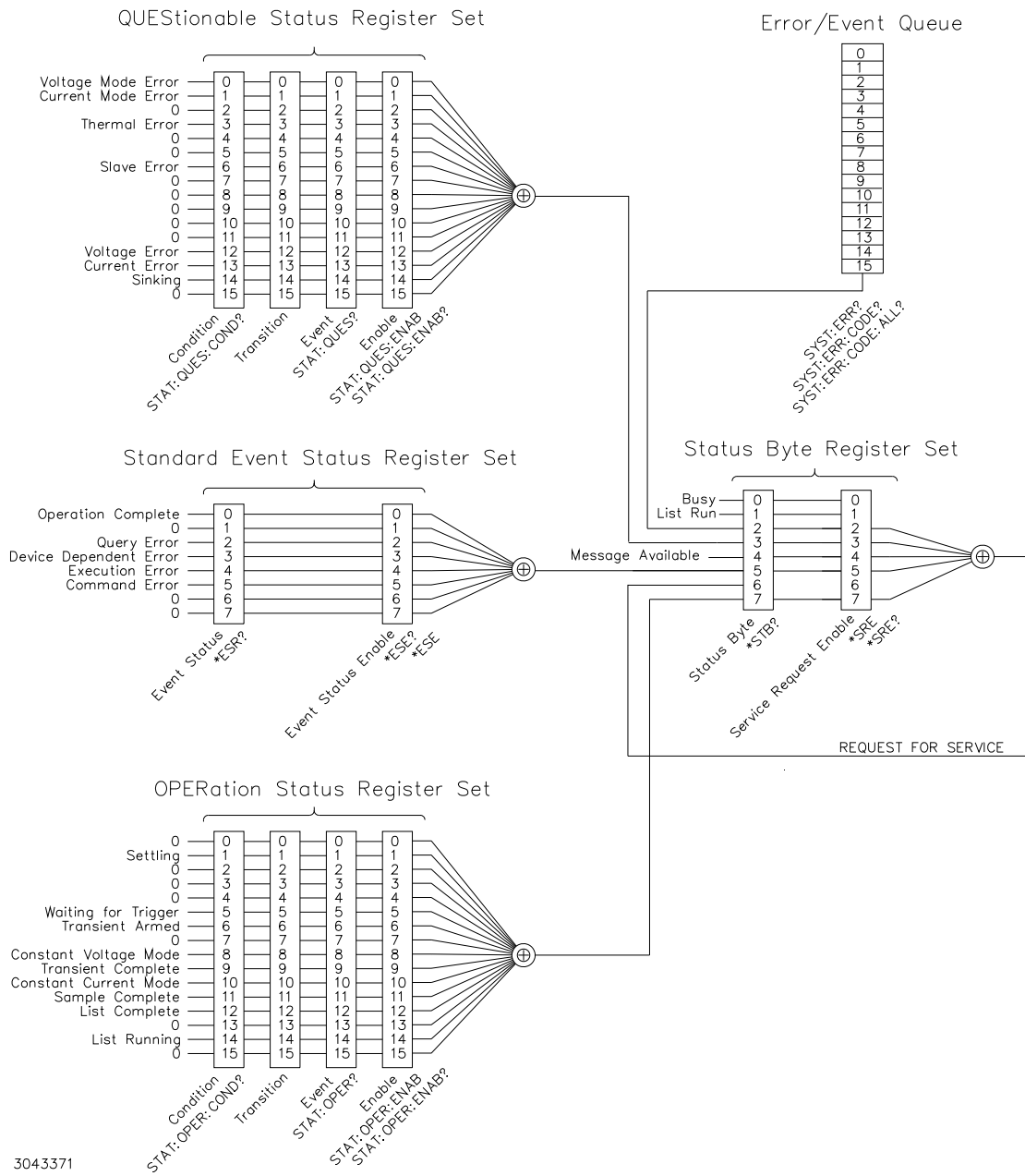

3043371

**FIGURE 3-27. STATUS REPORTING STRUCTURE**

**3.6.7.3 QUESTIONABLE STATUS REGISTER**

The QUESTIONable condition register (see Figure 3-27) contains status bits representing data/signals which give an indication of the quality of various aspects of the signal.

A bit set in the QUESTIONable condition register indicates that the data currently being acquired or generated is of questionable quality due to some condition affecting the parameter associated with that bit.

- 0 - Voltage Mode Error — 1 indicates the instrument is in Current mode.
- 1 - Current Mode Error — 1 indicates the Power Supply is in Voltage mode.
- 2 - Not Used — always zero.
- 3 - Thermal Error — 1 indicates a thermal error has been detected.
- 4 - 5 - Not Used — always zero.
- 6 - Slave Error — 1 indicates a slave fault in a master/slave configuration
- 7 - 11 - Not Used — always zero.
- 12 - Voltage Protect Error — 1 indicates a Voltage protection error has been detected. Front panel display also shows VPROTECT (see PAR. 3.3.3.2 for details).
- 13 - Current Protect Error — 1 indicates a Current protection error has been detected. Front panel display also shows CPROTECT (see PAR. 3.3.3.2 for details).

NOTE: If External Reference is enabled and a protection error occurs, both Voltage Protect Error (bit 12) and Current Protect Error (bit 13) are set. Front panel display also shows PROTECT (see PAR. 3.3.3.2 for details).

- 14 - Sinking — 1 indicates the unit is absorbing energy from the load.
- 15 Not Used — always zero.

### 3.6.8 SCPI PROGRAM EXAMPLES

Refer to Appendix B, Figures B-1 through B-18 for examples illustrating the use of SCPI commands.

Figure 3-28 is an example of a program using SCPI commands to program the BOP Power Supply. The program illustrated is for a configuration using an IBM PC or compatible with a National Instruments GPIB interface card. (It will be necessary to consult the manufacturer's data to achieve comparable functions with an interface card from a different manufacturer.) This program sets output voltage (Voltage mode) or voltage limit (Current mode) to 5V, and current limit (Voltage mode) or output current (Current mode) to 1A, then reads the measured (actual) voltage and current, then prints the measurements.

```

/*****
/* Sample Program For KEPCO power supply, using National Instruments */
/* GPIB interface card and IBM PC or compatible computer */
*****/

#include <stdio.h>
#include "decl.h"

char rd_str[80];           // Input buffer
char dat_str[80];        // Output buffer
int bd,adr;

main() {
    adr = ibfind("DEV6");           // Open DEV6 (defined by IBCONF)
    bd = ibfind ("GPIB0");         // Open GPIB card
    ibsic (bd);                    // Send Interface Clear
    ibsre(bd,1);                   // Set remote line true

    strcpy(dat_str,"VOLT 5;CURR 1"); // Define a set command
    strcat(dat_str,"\r\n");         // Append delimiter
    ibwrt(adr,dat_str,strlen(dat_str)); // Send string to power supply

    strcpy(dat_str,"MEAS:VOLT?;CURR?"); // Define a measure command
    strcat(dat_str,"\r\n");         // Append delimiter
    ibwrt(adr,dat_str,strlen(dat_str)); // Send string to power supply

    strset(rd_str,'\0');           // Clear input buffer
    ibrd(adr,rd_str,64);           // Read result of measure
    printf("received : %s\n",rd_str); // Print voltage and current
}

```

**FIGURE 3-28. TYPICAL EXAMPLE OF BOP POWER SUPPLY PROGRAM USING SCPI COMMANDS**





## SECTION 4 - CALIBRATION

### 4.1 GENERAL

This section contains the calibration instructions for the Power Supply. It is recommended that the user be familiar with Local Mode operation (PAR. 3.2) before calibrating the unit.

A full calibration consists of a voltage calibration and a current calibration. Both voltage and current calibrations consist of zero, max and min, and protection limit calibration. In addition, the control signals required for series and parallel operation of multiple units are also calibrated. It is recommended that the unit be recalibrated annually.

In order to enter the calibration mode the correct password may be required (see PAR. 3.2.4.3). If the password has been lost, call the factory and a special password will be provided. During the calibration, new calibration data is computed which is then stored in the nonvolatile memory.

Calibration of the BOP is performed in one of three ways: locally using the front panel keys (PAR. 4.4) or remotely by sending commands through either the GPIB or RS 232 bus (PAR. 4.3). These two ways cannot be combined.

**NOTE:** During calibration, various circuits of the BOP are verified. If an error occurs during the verification process, the unit will beep and an error 24(x), Hardware, (see PAR. B.159) will be placed in the error queue.

**TABLE 4-1. CALIBRATION SUMMARY**

Type	Step	Reference Type and Value	Monitored Parameter	Output Conditions	Notes
VOLTAGE INTERNAL	1. ZERO 2. POSITIVE 3. NEGATIVE	Internal	Output Voltage 1. 0.0v 2. +Voltage FS 3. -Voltage FS	NO LOAD AUTOMATIC VM	1. DVM between OUT S and COM S. 2. Adjust for zero, positive and negative FS.
VOLTAGE PROTECTION	1. POSITIVE 2. NEGATIVE	Internal	Output Voltage 1. +Voltage FS 2. -Voltage FS	NO LOAD AUTOMATIC CM	1. DVM between OUT S and COM S. 2. Adjust for positive and negative FS.
VOLTAGE EXTERNAL	1. ZERO 2. POSITIVE	External: 1. 0.0V 2. +10.0V (Analog I/O Port, pin 11 ref to pin 10)	Output Voltage 1. 0.0v 2. +Voltage FS	NO LOAD AUTOMATIC VM	1. DVM between OUT S and COM S. 2. Adjust for zero, positive FS.
VOLTAGE GAIN	1. ZERO 2. POSITIVE	External: 1. 0.0V 2. +10.0V (Analog I/O Port pin 11 ref to pin 10)	Output Voltage: 1. 0.0V 2. 0.0V	No Load Automatic VM	1. DVM between OUT S and COM S 2. Adjust for zero (both Zero and Positive).
CURRENT, INTERNAL	1. ZERO 2. POSITIVE 3. NEGATIVE	Internal	Output Current: 1. 0.0A 2. +Current FS 3. -Current FS	Short with Meas. Shunt Automatic CM	1. DVM between probe terminals of Meas. Shunt (LO towards COM S) 2. Adjust for zero, positive and negative FS

**TABLE 4-1. CALIBRATION SUMMARY (CONTINUED)**

Type	Step	Reference Type and Value	Monitored Parameter	Output Conditions	Notes
CURRENT, PROTECTION	1. POSITIVE 2. NEGATIVE	Internal	Output Current: 1. +Current FS 2. -Current FS	Short with Meas. Shunt Automatic VM	1. DVM between probe terminals of Meas. Shunt (LO towards COM S) 2. Adjust for positive and negative FS.
CURRENT, EXTERNAL	1. ZERO 2. POSITIVE	External: 1. 0.0V 2. +10.0V (Analog I/O Port pin 11 ref to pin 10)	Output Current: 1. 0.0A 2. +Current FS	Short with Meas. Shunt Automatic CM	1. DVM between probe terminals of Meas. Shunt (LO towards COM S). 2)Adjust for zero, pos FS.
CURRENT, GAIN	1. ZERO 2. POSITIVE	External: 1. 0.0V 2. +10.0V (Analog I/O Port pin 11 ref to pin 10)	Output Current: 1. 0.0A 2. 0.0A	Short with Meas. Shunt Automatic CM	1. DVM between probe terminals of Meas. Shunt (LO towards COM S) 2. Adjust for zero (both Zero and Positive)
EXTERNAL CONTROLS, I_OUT	1. ZERO 2. POSITIVE	INTERNAL	Voltage at Par/Ser CTRL-IN Port pin 6 ref. to pin1: 1. 0.0V 2. +10.0V	Short with Meas. Shunt Automatic CM	1. DVM at Par/Ser CTRL-IN Port pin 6 ref. to pin 1 2. Adjust for zero, +10.0V
EXTERNAL PROTECTION, Pos. Voltage Neg. Voltage Pos. Current Neg. Current (together)	1. ZERO 2. FULL SCALE	External: 1. 0.0V 2. +10.0V (Analog I/O Port pins 14, 6, 13, 5 ref to pin12)	N/A	No requirements	Automatic internal measurement

## 4.2 TEST EQUIPMENT REQUIREMENTS

Table 4-2 lists sense resistors recommended for measuring current and includes Kepco and Manufacturer's part numbers. The value of the sense resistor chosen should be known with 0.001% accuracy. If other than a recommended sense resistor is to be used, it must be rated for at least 100W power dissipation (actual power dissipation will be approximately 10W). The thermal coefficient of the sense resistor chosen should be 10 ppm/°C or better.

The digital voltmeter (DVM) used to measure output voltage and the voltage across the current sensing resistor should have at least six digits, multiple ranges, the smallest resolution must be at least one microvolt and the accuracy must be at least 0.0001%.

To calibrate the external programming capabilities of the BOP a DC reference voltage with the following minimum specifications is required.

- Value: 0.0V ±0.1mV and 10.0V ±0.1mV (either positive and negative or floating)
- Stability: better than 10<sup>-5</sup>
- Internal Impedance: better than 0.1 Ohms
- Output Current: >0.5mA when sourcing, >0.15mA when sinking

**TABLE 4-2. SUGGESTED SENSE RESISTORS**

MODEL	VALUE	KEPCO PART NO.	MANUFACTURER	MANUFACTURER PART NO.
BOP 6-250 BOP 10-200 BOP 12-125 BOP 20-100 BOP 25-80 BOP 36-56 BOP 40-50	0.001 OHM	115-3033	ISOTEK	RUG-Z-R001-0.1 TK10
BOP 50-40 BOP 72-28 BOP 100-20 BOP 144-10 BOP 200-10	0.01 OHM	115-2997	ISOTEK	RUG-Z-R010-0.1 TK10

NOTE: Selected sense resistor must be mounted on a heatsink with a minimum surface area of 36 square inches to maintain thermal stability during calibration; forced cooling is recommended. Kepco Heatsink P/N 136-0451 will provide adequate cooling for the sense resistor.

**TABLE 4-3. VOLTAGE CALIBRATION MEASUREMENTS AND TOLERANCES**

MODEL	VOLTAGE ZERO (TOLERANCE)	±FULL SCALE VOLTAGE			±FULL SCALE VPR LIMIT		
		MAX.	MIN.	TOLERANCE	MAX.	MIN.	TOLERANCE
BOP 6-250	0V (±0.001V)	6V	-6V	±0.001V	6V	-6V	±0.002V
BOP 10-200	0V (±0.001V)	10V	-10V	±0.001V	10V	-10V	±0.003V
BOP 12-125	0V (±0.0012V)	12V	-12V	±0.002V	12V	-12V	±0.004
BOP 20-10	0V (±0.002V)	20V	-20V	±0.002V	20V	-20V	±0.006V
BOP 25-80	0V (±0.003V)	25V	-25V	±0.003V	25V	-25V	±0.008V
BOP 36-56	0V (±0.0036V)	36V	-36V	±0.0036V	36V	-36V	±0.01V
BOP 40-50	0V (±0.004V)	40V	-40V	±0.004V	40V	-40V	±0.012
BOP 50-40	0V (±0.005V)	50V	-50V	±0.005V	50V	-50V	±0.015V
BOP 72-28	0V (±0.0072V)	72V	-72V	±0.0072V	72V	-72V	±0.022V
BOP 100-20	0V (±0.01V)	100V	-100V	±0.01V	100V	-100V	±0.03V
BOP 144-14	0V (±0.014V)	144V	-144V	±0.0144V	144V	-144V	±0.044
BOP 200-10	0V (±0.02V)	200V	-200V	±0.02V	200V	-200V	±0.06

**TABLE 4-4. CURRENT CALIBRATION MEASUREMENTS AND TOLERANCES**

MODEL	SENSE RESISTOR VALUE (SEE NOTE AND TABLE 4-2)	CURRENT ZERO (TOLERANCE)	±FULL SCALE CURRENT			±FULL SCALE CPR LIMIT		
			MAX.	MIN.	TOLERANCE	MAX.	MIN.	TOLERANCE
BOP 6-250	0.001 Ohm	0V (±0.0025mV)	0.25V	-0.25V	±0.0025mV	0.25V	-0.25V	±0.125mV
BOP 10-200	0.001 Ohm	0V (±0.02mV)	0.2V	-0.2V	±0.02mV	0.2V	-0.2V	±0.1mV
BOP 12-125	0.001 Ohm	0V (±0.013mV)	0.125V	-0.125V	±0.013mV	0.125V	-0.125V	±0.063mV
BOP 20-100	0.001 Ohm	0V (±0.01mV)	0.1V	-0.1V	±0.01mV	0.1V	-0.1V	±0.05mV
BOP 25-80	0.001 Ohm	0V (±0.008mV)	0.08V	-0.08V	±0.008mV	0.08V	-0.08V	±0.04mV
BOP 36-56	0.001 Ohm	0V (±0.0056mV)	0.056V	-0.056V	±0.0056mV	0.056V	-0.056V	±0.028mV
BOP 40-50	0.001 Ohm	0V (±0.005mV)	0.05V	-0.05V	±0.005mV	0.05V	-0.05V	±0.025mV
BOP 50-40	0.001 Ohm	0V (±0.004mV)	0.04V	-0.04V	±0.004mV	0.04V	-0.04V	±0.02mV
BOP 72-28	0.001 Ohm	0V (±0.003mV)	0.028V	-0.028V	±0.003mV	0.028V	-0.028V	±0.014mV
BOP 100-20	0.01 Ohm	0V (±0.02mV)	0.2V	-0.2V	±0.02mV	0.2V	-0.2V	±0.1mV
BOP 144-14	0.01 Ohm	0V (±0.0144mV)	0.144V	-0.144V	±0.0144mV	0.144V	-0.144V	±0.072mV
BOP 200-10	0.01 Ohm	0V (±0.01mV)	0.1	-0.1	±0.01mV	0.1	-0.1	±0.05mV
<b>REFER TO NOTES FOR SENSE RESISTOR VALUE OTHER THAN LISTED HERE</b>	<b>R<sub>SENSE</sub></b> SEE NOTES.	SEE NOTE A.	SEE NOTE B.	SEE NOTE B.	SEE NOTE B.	SEE NOTE C.	SEE NOTE C.	SEE NOTE C.
<b>USE SPACE PROVIDED AT RIGHT FOR CALCULATED VALUES.</b>								

**NOTES:** The following formulas are used to calculate proper calibration values for Sense Resistors other than those recommended.

**R<sub>SENSE</sub>** = the measured value of the sense resistor in ohms (0.001% accuracy).

**I<sub>Onom</sub>** = Nominal (rated) current output of BOP in Amperes (e.g., for BOP 50-20M, I = 20A)

**A. 0V, Tolerance = ±(R<sub>SENSE</sub>) × (0.1) × (I<sub>Onom</sub>)-- result in mV.**

**B. (R<sub>SENSE</sub>) × (I<sub>Onom</sub>)--result in V, Tolerance = ±(R<sub>SENSE</sub>) × (0.1) × (I<sub>Onom</sub>)--result in mV.**

**C. (R<sub>SENSE</sub>) × (I<sub>Onom</sub>)--result in V, Tolerance = ±(R<sub>SENSE</sub>) × (0.5) × (I<sub>Onom</sub>)--result in mV.**

### 4.3 CALIBRATION USING REMOTE SCPI COMMANDS VIA GPIB OR RS 232 INTERFACE

The primary means of adjustment are the **CAL:DATA** commands. Basically these commands are fine and coarse adjustments, however there are slight differences in how they work for different types of calibrations.

a. **ZERO Calibrations (always done first).** The only means of adjustment is the **CAL:DATA <VALUE>** command which provides a total of 4095 increments of adjustment starting at 0, with 2047 increments in either direction to achieve maximum output levels of  $\pm 2.5\%$  of  $E_{\text{Onom}}$ . Adjust the output to obtain the closest value to zero.

b. **MAX and MIN Calibrations.** The primary means of adjustment is the **CAL:DATA <VALUE>** command to either increase (**CAL:DATA 1**) or decrease (**CAL:DATA -1**) the output value. Adjustment can be done in larger increments by increasing the numeric value, e.g., **CAL:DATA +10** or **CAL:DATA -10**. Adjust the output to obtain the closest value above the full scale value.

c. **VPR and CPR Calibrations.** The only means of adjustment is the **CAL:DATA <VALUE>** command which provides a total of 4095 increments of adjustment from zero to maximum. Adjust the output to obtain the closest value above the full scale value.

#### 4.3.1 CALIBRATION PROCEDURE USING SCPI COMMANDS

The following procedure provides a complete calibration of the unit.

- NOTES:
1. For ZERO calibration, adjust output to obtain value closest to zero.
  2. For FULL SCALE calibration adjust the output to obtain the closest value above the nominal full scale value.
  3. Set the unit for local sensing with GND Network in (see Figure 4-1) and disconnect load from BOP output to prepare the unit for voltage calibration.



**CAUTION: Sending commands other than SYST:ERR? during calibration will adversely affect calibration of the unit.**

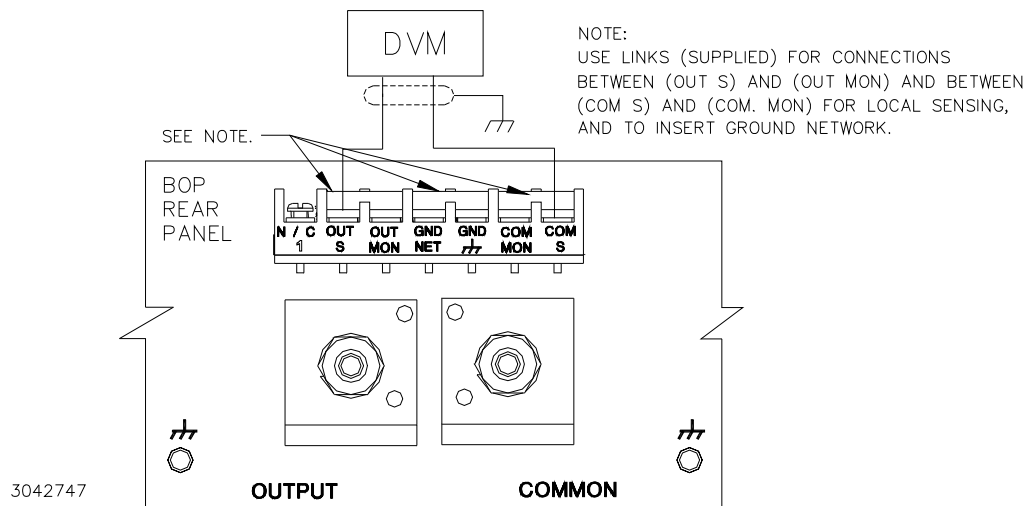

FIGURE 4-1. CALIBRATION SETUP FOR VOLTAGE MODE

1. Initiate calibration by sending the SCPI command **SYSTem:PASSword:CENable DEFAULT** and then send **CAL:STATE 1**. The password **DEFAULT** has been set at the factory. If the password has been changed from **DEFAULT**, substitute the correct password for the unit in the **SYST:PASS:CEN** command. If the password has been lost, consult factory.
2. Set the BOP to zero volts output by sending **CAL:VOLT ZERO**. Connect a Digital Voltmeter (DVM) to the BOP OUT S and COM S terminals to measure the output voltage. Send **CAL:DATA** commands as needed (see PAR. 4.3a) to adjust the BOP output until the DVM reads as close to zero as possible within tolerance specified in Table 4-3 for VOLTAGE ZERO.
3. Set the BOP to maximum positive output voltage by sending **CAL:VOLT MAX**. Measure the voltage output using the DVM. To adjust, send **CAL:DATA** commands as needed (see PAR. 4.3b) until the DVM reading is as close as possible above the nominal full scale value within the tolerance specified in Table 4-3 for +FULL SCALE VOLTAGE.
4. Set the BOP to maximum negative output voltage by sending **CAL:VOLT MIN**. To adjust, send the **CAL:DATA** command as needed (see PAR. 4.3b) until the reading is as close as possible above (absolute value) the nominal full scale value within the limits specified in Table 4-3 for –FULL SCALE VOLTAGE.
5. Send **CAL:VPR MAX** to adjust the maximum positive voltage protection limit of the power supply. Send the **CAL:DATA** commands as needed (see PAR. 4.3c) until the reading is as close as possible above the nominal full scale value within the limits specified in Table 4-3 for +FULL SCALE VPR LIMIT.
6. Send **CAL:VPR MIN** to adjust the maximum negative protection limit of the power supply. Send the **CAL:DATA** commands as needed (see PAR. 4.3c) until the reading is as close as possible above (absolute value) the nominal full scale value within the limits specified in Table 4-3 for –FULL SCALE VPR LIMIT.
7. Connect a 0V  $\pm 0.1$ mV d-c reference to pin 11 (EXT\_REF) referenced to pin 10 (SGND) of the Analog I/O Port connector (A2A5J6). Set the BOP to zero volts output by sending **CAL:VEXT ZERO**. Connect the DVM to the BOP output and send **CAL:DATA** commands as needed (see PAR. 4.3a) to adjust the BOP output until the DVM reads as close to zero as possible within tolerance specified in Table 4-3 for VOLTAGE ZERO.

NOTE: Accuracy of the 10V d-c reference must be  $\pm 0.1$ mV in order for the calibrated unit to meet published specifications.

8. Replace 0V reference at pin 11 (EXT\_REF) of the Analog I/O Port connector (A2A5J6) with a +10V d-c reference. Set the BOP to maximum positive output voltage by sending **CAL:VEXT MAX**. Measure the voltage output using the DVM. To adjust, send **CAL:DATA** commands as needed (see PAR. 4.3b) until the DVM reading is as close as possible above the nominal full scale value within the tolerance specified in Table 4-3 for +FULL SCALE VOLTAGE.
9. Replace +10V reference at pin 11 (EXT\_REF) of the Analog I/O Port connector (A2A5J6) with a 0V  $\pm 0.1$ mV d-c reference. Set the BOP to zero volts output by sending **CAL:VGA ZERO**. Connect DVM to the BOP OUT S and OUT COM terminals to measure the output voltage. Send **CAL:DATA** commands as needed (see PAR. 4.3a) to adjust the BOP output until the DVM reads as close to zero as possible within tolerance specified in Table 4-3 for VOLTAGE ZERO.

10. Replace 0V reference at pin 11 (EXT\_REF) of the Analog I/O Port connector (A2A5J6) with a +10V d-c reference. Set the BOP to maximum positive output voltage by sending **CAL:VGA MAX**. Measure the output voltage using the DVM. To adjust, send **CAL:DATA** commands as needed (see PAR. 4.3a) until the DVM reading is as close to zero as possible within tolerance specified in Table 4-3 for VOLTAGE ZERO.
11. Set the BOP to zero volts output by sending **CAL:ZERO**. Disconnect the +10V d-c reference voltage from the analog I/O port external reference pin (A2A5J6 pin 11) of the BOP, then connect 0V  $\pm$ 0.1mV d-c reference voltage from the external voltage source to +V\_LIM\_EXT (pin 14), -V\_LIM\_EXT (pin 6), +I\_LIM-EXT (pin 13) and -I\_LIM-EXT (pin 5) referenced to pin 12 (GND1) of the BOP analog I/O connector (A2A5J6), then send the **CAL:VLIM ZERO** command. This enables the BOP to recognize that the voltage at the  $\pm$ VLIM\_EXT pins is 0V.
12. Set the BOP to zero amperes output by sending **CAL:CLIM ZERO**. This enables the BOP to recognize that the voltage at the  $\pm$ I\_LIM\_EXT pins is 0V. Then send **CAL:ZERO** command.
13. Connect +10.0V  $\pm$ 0.1mV d-c reference voltage from the external voltage source to +V\_LIM\_EXT (pin 14), -V\_LIM\_EXT (pin 6), +I\_LIM-EXT (pin 13) and -I\_LIM-EXT (pin 5) referenced to pin 12 (GND1) of the BOP analog I/O connector (A2A5J6), then send **CAL:VLIM MAX**. This enables the BOP to recognize that the voltage at voltage at the  $\pm$ VLIM\_EXT pins is 10.0V. Then send **CAL:ZERO** command.
14. Send **CAL:CLIM MAX** command. This enables the BOP to recognize that the voltage at the +I\_LIM\_EXT pin is 10.0V. Then send **CAL:ZERO** command.
15. Set the BOP to minimum (maximum negative) output by sending **CAL:VLIM MIN** command. This enables the BOP to recognize that the voltage at the -VLIM\_EXT pin is 10.0V. Then send the **CAL:ZERO** command.
16. Set the BOP to minimum (maximum negative) output by sending **CAL:CLIM MIN** command. This enables the BOP to recognize that the voltage at the -I\_LIM\_EXT pin is 10.0V. Then send the **CAL:ZERO** command.
17. Send **CAL:ZERO** to prepare for current calibration. After sending the command, the BOP output will be set to zero volts. Refer to Figure 4-2 to connect the C terminals of the Kelvin type sense resistor to the BOP and connect the DVM to the P (probe) terminals of the sense resistor ((LO terminal of DVM to common P terminal). Table 4-4 provides recommended sense resistor values for various BOP current outputs, as well as the formula for calculating expected measured values and tolerances for any sense resistor other than those recommended. Table 4-2 lists Kepco and Manufacturer part numbers for those sense resistors recommended.

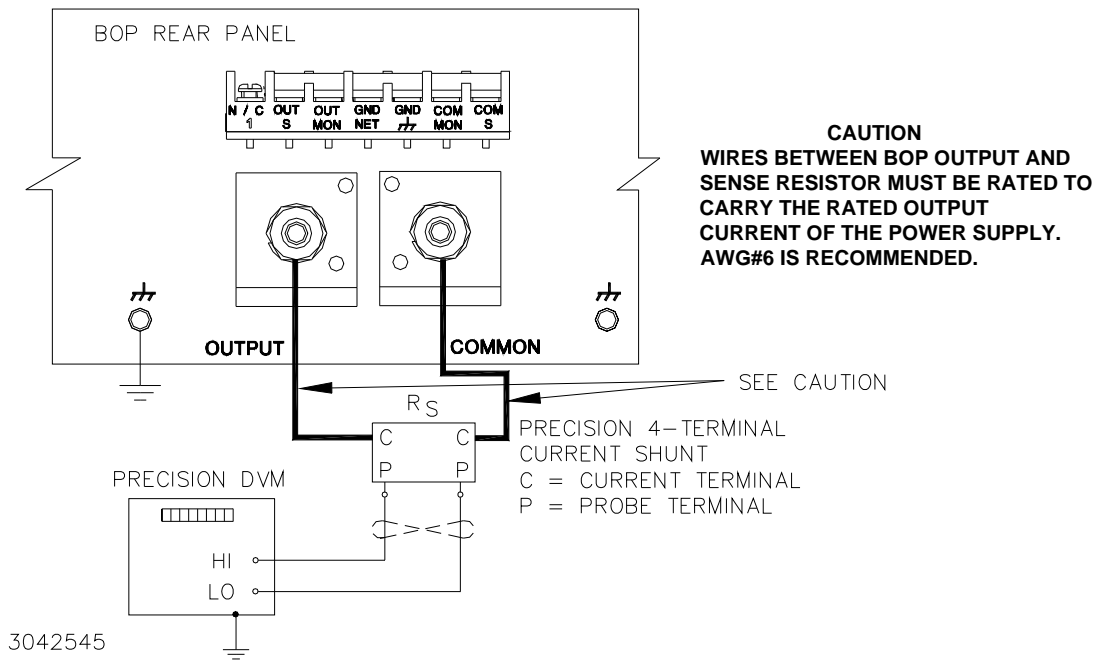

**FIGURE 4-2. CALIBRATION SETUP FOR CURRENT MODE**



**The sense resistor will be dissipating full rated current of the BOP. If it is hot to the touch, the sense resistor value, power rating and/or cooling are incorrect; refer to PAR. 4.3 and Table 4-2.**

18. Set the BOP to zero volts across the sense resistor (corresponding to zero current) by sending `CAL:CURRE ZERO`. Send `CAL:DATA` commands as needed (see PAR. 4.3a) until the reading is as close to zero as possible within the limits specified in Table 4-4 for CURRENT ZERO.
19. Set the BOP to maximum positive output current by sending `CAL:CURRE MAX`. Measure the current by reading the voltage across the sense resistor. To adjust, send `CAL:DATA` commands as needed (see PAR. 4.3b) to adjust the BOP output until the DVM reads as close as possible above the nominal full scale value within tolerance specified in Table 4-4 for +FULL SCALE CURRENT.
20. Set the BOP to maximum negative output current by sending `CAL:CURRE MIN`. Continue to measure the output current of the supply using the DVM connected to the sense resistor. To adjust, send `CAL:DATA` commands as needed (see PAR. 4.3b) to adjust the BOP output until the DVM reads as close as possible above (absolute value) the nominal full scale value within tolerance specified in Table 4-4 for -FULL SCALE CURRENT.
21. Send `CAL:CPR MAX` to adjust the maximum positive current protection limit of the power supply. To adjust, send `CAL:DATA` commands as needed (see PAR. 4.3c) to adjust the BOP



output until the DVM reads as close as possible above the nominal full scale value within tolerance specified in Table 4-4 for +FULL SCALE CPR LIMIT.

22. Send **CAL:CPR MIN** to adjust the minimum (maximum negative) current protection limit of the power supply. To adjust, send **CAL:DATA** commands as needed (see PAR. 4.3c) to adjust the BOP output until the DVM reads as close as possible above (absolute value) the nominal full scale value within tolerance specified in Table 4-4 for –FULL SCALE CPR LIMIT.
23. Send **CAL:ZERO** to set the BOP output to zero. Connect 0V  $\pm$ 0.1mV d-c reference voltage to external reference pin 11 referenced to pin 10 (SGND) of the BOP analog I/O port (A2A5J6). Set the BOP to zero volts across the sense resistor (corresponding to zero current) by sending **CAL:CEXT ZERO**. Send **CAL:DATA** commands as needed (see PAR. 4.3a) until the reading is as close to zero as possible within the limits specified in Table 4-4 for CURRENT ZERO.
24. Replace the 0V d-c reference applied to analog I/O port A2A5J6 pin 11 with a +10V  $\pm$ 0.1mV d-c reference voltage. Set the BOP to maximum positive output current by sending **CAL:CEXT MAX**. Measure the current by reading the voltage across the sense resistor. To adjust, send **CAL:DATA** commands as needed (see PAR. 4.3b) to adjust the BOP output until the DVM reads as close as possible above the nominal full scale value within tolerance specified in Table 4-4 for +FULL SCALE CURRENT.
25. Replace the +10V d-c reference applied to analog I/O port A2A5J6 pin 11 with a 0V  $\pm$ 0.1mV d-c reference voltage. Set the BOP to zero volts across the sense resistor (corresponding to zero current) by sending **CAL:CGA ZERO**. Send **CAL:DATA** commands as needed (see PAR. 4.3a) until the reading is as close to zero as possible within the limits specified in Table 4-4 for CURRENT ZERO.
26. Replace the 0V d-c reference applied to analog I/O port A2A5J6 pin 11 with a +10V  $\pm$ 0.1mV d-c reference voltage. Set the BOP to maximum positive output current by sending **CAL:CGA MAX**. Measure the current by reading the voltage across the sense resistor. To adjust, send **CAL:DATA** commands as needed (see PAR. 4.3a) to adjust the BOP output until the DVM reads as close as close to zero as possible within the limits specified in Table 4-4 for CURRENT ZERO.
27. Send **CAL:ZERO** to prepare for calibration of IOUT\_M\_UNIT (master output) control signal. Connect the DVM to pin 6 (IOUT\_M\_UNIT) referenced to pin 1 (SGND) of the PAR/SER CONTROL IN connector (A2A5J3). Set the BOP to zero output current by sending **CAL:IOUT ZERO**. Send **CAL:DATA** commands as needed (see PAR. 4.3b) to adjust the BOP output until the DVM reads 0V  $\pm$ 1mV.
28. Set the BOP to maximum positive output current by sending **CAL:IOUT MAX**. With the DVM still connected to pin 6 (IOUT\_M\_UNIT) referenced to pin 1 (SGND) of the PAR/SER CONTROL IN connector measure the voltage output using the DVM. Send **CAL:DATA** commands as needed (see PAR. 4.3b) until the DVM reading is +10V  $\pm$ 1.0mV.
29. Save the calibration levels by sending **CAL:SAVE 12/21/2003**. The characters at the end are optional and represent the calibration date of the power supply. The date entered in this manner is reported in the **\*idn?** query.

#### 4.4 CALIBRATION USING FRONT PANEL KEYPAD IN LOCAL MODE

The following paragraphs describe the screens and keys used in the calibration process.

#### 4.4.1 UNDERSTANDING THE CALIBRATION PROCESS

The following steps describe the calibration screens, and associated keys active during the calibration process. Refer to PAR. 4.4.2 for full calibration procedure.

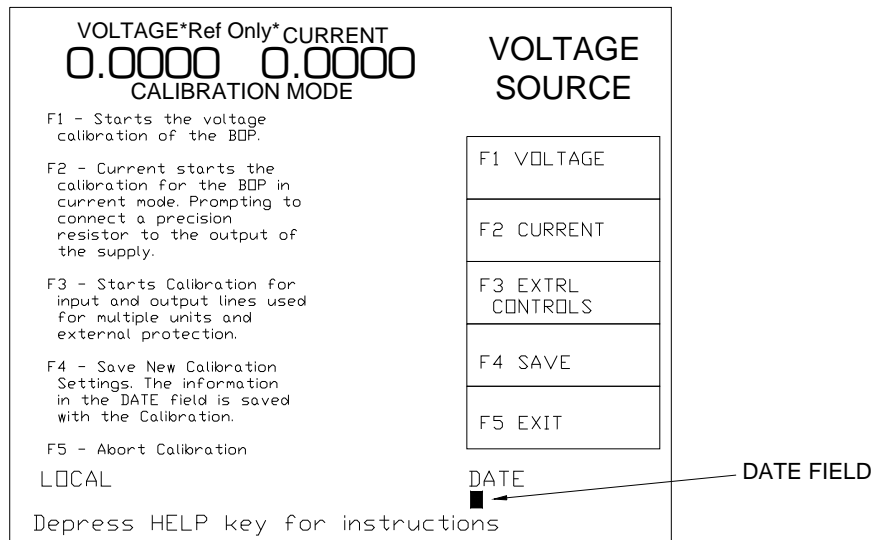

1. From the power-up screen, press **F5** to enter the General Setup menu, then highlight Calibration and press **F1**.
2. Enter the password (see PAR. 3.2.4.3), and press **F1**. The LCD shows main calibration screen (Figure 4-3) which includes explanations for the following function keys:
  - **F1** - VOLTAGE - Selects the voltage calibration of the BOP.
  - **F2** - CURRENT - Starts the calibration for the BOP in current mode.
  - **F3** - EXTRL CONTROLS - Selects input and output signal calibration used for multiple units and the external protection.
  - **F4** - SAVE - Save New Calibration Setting. The information in the DATE field is saved with the Calibration.
  - **F5** or **ENTER** - EXIT







3042519-3

**FIGURE 4-3. MAIN CALIBRATION SCREEN**













3. Press either **F1** or **F2** to initiate Voltage or Current calibration, respectively. To calibrate multiple units refer to the Instruction Manual Included with the associated parallel or series connection cable kit. The LCD shows the explanations for the following function keys:
  - **F1** - INTERNAL - Selects the voltage calibration of the BOP.
  - **F2** - GAIN - Starts the calibration of the external gain mode of the power supply.
  - **F3** - EXTERNAL - Starts the external reference calibration.

-  - PROTECT - Starts the protection limits calibration of the power supply.
-  or **ENTER** - EXIT - Exit Voltage or Current Calibration

4. Pressing , , , or  displays following explanations for the function keys:



**CAUTION: IF THE CALIBRATE ZERO  FUNCTION IS AVAILABLE, PERFORM THIS FUNCTION FIRST, AS IT AFFECTS ALL OTHER OUTPUT CALIBRATIONS.**

-  - Calibrate the Zero adjustment for this operational mode. IF THIS FUNCTION IS AVAILABLE, PERFORM THIS FUNCTION FIRST, AS IT AFFECTS ALL OTHER OUTPUT calibrations.
  -  - Adjust the MAXIMUM (Positive) for this operational mode.
  -  - Adjusts the MINIMUM (Negative) for this operational mode
  -  - PROTECT - Adjusts External Protection limits. (Active for EXTERNAL screen only.)
  -  or **ENTER** to exit this menu.
5. Selecting one of the above options begins calibrating the output. The screen describes the function of the active keys:
-  - or clockwise rotation of the **ADJUST** control adjust the output by approximately 10 increments in the positive direction.
  -  - or clockwise rotation of the **ADJUST** control while pressed adjusts the output by one increment in the positive direction.
  -  - or counterclockwise rotation of the **ADJUST** control adjusts the output by 10 increments in the negative direction.
  -  - or counterclockwise rotation of the **ADJUST** control adjust the output by approximately 10 increments in the negative direction.
  -  - Exits the active calibration and allows you to select other calibrations that are required.
  -  - Increments the output D to A by 100, causing the output to increase.
  -  - Decrements the output D to A by 100, causing the output to decrease.









#### 4.4.2 CALIBRATION PROCEDURE USING LOCAL MODE

- NOTES:
1. For ZERO calibration, adjust output to obtain value closest to zero.
  2. For FULL SCALE calibration adjust the output to obtain the closest value above (absolute value) the nominal full scale value.
  3. Set the unit for local sensing with GND Network in (see Figure 4-1) and disconnect load from BOP output.
  4. When adjustment is needed refer to PAR. 4.4.1, step 5.

1. From the power-up screen, press **F5** to enter the General Setup menu, then highlight Calibration and press **F1**. Enter the password (see PAR. 3.2.4.3), and press **F1**. The LCD shows main calibration screen.
2. Press **F1** - VOLTAGE, **F1** - INTERNAL, **F1** - ZERO to set the BOP to zero volts output. Connect a Digital Voltmeter (DVM) to the BOP OUT S and COM S terminals to measure the output voltage. Adjust the BOP output as needed until the DVM reads as close to zero as possible within tolerance specified in Table 4-3 for VOLTAGE ZERO. Press **F5** once.
3. Press **F2** - POSITIVE. Measure the voltage output using the DVM. Adjust as needed until the DVM reading is as close as possible above the nominal full scale value within the tolerance specified in Table 4-3 for +FULL SCALE VOLTAGE. Press **F5** once.
4. Press **F3** - NEGATIVE to set the BOP to maximum negative output voltage and adjust as needed until the reading is as close as possible above the nominal full scale value within the limits specified in Table 4-3 for –FULL SCALE VOLTAGE. Press **F5** twice.
5. Press **F4** - PROTECT, **F2** - POSITIVE to adjust the maximum positive voltage protection limit of the power supply while working in current mode. Adjust as needed until the reading is as close as possible above the nominal full scale value within the limits specified in Table 4-3 for +FULL SCALE VPR LIMIT. Press **F5** once.
6. Press **F3** - NEGATIVE to adjust the maximum negative protection limit of the power supply. Adjust as needed until the reading is as close as possible above the nominal full scale value within the limits specified in Table 4-3 for –FULL SCALE VPR LIMIT. Press **F5** three times.
7. Press **F3** - EXTRL CONTROLS, **F4** - EXTERN PROTECT. Connect 0V  $\pm$ 0.1mV d-c reference voltage from the external voltage source to the following pins of analog I/O connector (A2A5J6) referenced to pin 12 (GND1): +V\_LIM\_EXT (pin 14), –V\_LIM\_EXT (pin 6), +I\_LIM\_EXT (pin 13) and –I\_LIM\_EXT (pin 5). Then press **F1** - ZERO. This enables the BOP to recognize that the voltage at the four \_EXTERNAL pins (14, 6, 13, and 5) is 0V. Press **F5** once.













NOTE: Accuracy of the 10V d-c reference must be  $\pm$ 0.1mV in order for the calibrated unit to meet published specifications.

8. Press **F4** - EXTRL PROTECT. Replace 0V  $\pm$ 0.1mV d-c reference voltage at pins 14, 6, 13, and 5 with +10.0V  $\pm$ 0.1mV d-c reference voltage from the external voltage source referenced to pin 12 (GND1) of the analog I/O connector (A2A5J6), then press **F2** - MAXIMUM. This enables the BOP to recognize that the voltage at the four \_POSITIVE pins (14, 6, 13, and 5) is 10.0V. Then press **F5** twice.
9. Disconnect +10.0V d-c reference voltage from pins 14, 6, 13 and 6 of analog I/O connector (A2A5J6). Connect a +0V  $\pm$ 0.1mV d-c reference voltage to EXT\_REF, pin 11, referenced to pin 10 (SGND1), of the BOP analog I/O port (A2A5J6).
10. Press **F1** - VOLTAGE, **F3** - EXTERNAL, **F1** - ZERO to set the BOP to zero volts output. Adjust as needed until the DVM reads as close to zero as possible within the limits specified in Table 4-3 for VOLTAGE ZERO. Press **F5** twice.

11. Press  - GAIN,  - ZERO to set the BOP to zero volts output. Adjust as needed until the DVM reads as close to zero as possible within the limits specified in Table 4-3 for VOLTAGE ZERO. Press  twice.
12. Connect +10.0V  $\pm$ 0.1mV d-c reference voltage from the external voltage source to EXT\_REF, pin 11, referenced to pin 10 (SGND) of Analog I/O Port connector (A2A5J6), Press  - GAIN,  - POSITIVE. Adjust as needed until the DVM reads as close to zero as possible within the limits specified in Table 4-3 for VOLTAGE ZERO. Press  twice.
13. Press  - EXTERNAL,  - POSITIVE. Adjust as needed until the DVM reads as close as possible above the nominal full scale value within tolerance specified in Table 4-3 for +FULL SCALE VOLTAGE. Press  three times.
14. Refer to Figure 4-2 to connect the C terminals of the Kelvin type sense resistor to the BOP and connect the DVM to the P (probe) terminals of the sense resistor ((LO terminal of DVM to common P terminal). Table 4-4 provides recommended sense resistor values for various BOP current outputs, as well as the formula for calculating expected measured values and tolerances for any sense resistor other than those recommended. Table 4-2 lists Kepeco and Manufacturer part numbers for those sense resistors recommended.



**The sense resistor will be dissipating full rated current of the BOP. If it is hot to the touch, the sense resistor value, power rating and/or cooling are incorrect; refer to PAR. 4.4 and Table 4-2.**

15. Press  - CURRENT,  - INTERNAL,  - ZERO to set the BOP to zero volts across the sense resistor (corresponding to zero current). Adjust as needed until the reading is as close to zero as possible within the limits specified in Table 4-4 for CURRENT ZERO. Press  once.
16. Press  - POSITIVE to set the BOP to maximum positive output current. Measure the current by reading the voltage across the sense resistor. Adjust as needed until the DVM reads as close as possible above the nominal full scale value within tolerance specified in Table 4-4 for +FULL SCALE CURRENT. Press  once.
17. Press  - NEGATIVE to set the BOP to maximum negative output current. Continue to measure the output current of the supply using the DVM connected to the sense resistor. Adjust as needed until the DVM reads as close as possible above the nominal full scale value within tolerance specified in Table 4-4 for –FULL SCALE CURRENT. Press  twice.
18. Press  - PROTECT,  - POSITIVE to set to adjust the maximum positive current protection limit of the power supply in voltage mode. Adjust as needed until the DVM reads as close as possible above the nominal full scale value within tolerance specified in Table 4-4 for +FULL SCALE CPR LIMIT. Press  once.
19. Press  - NEGATIVE to adjust the minimum (maximum negative) current protection limit of the power supply. Adjust as needed until the DVM reads as close as possible above the nominal full scale value within tolerance specified in Table 4-4 for –FULL SCALE CPR LIMIT. Press  twice.

20. Connect a  $+0V \pm 0.1mV$  d-c reference voltage to external reference, A2A5J6 pin 11, referenced to pin 10 (SGND) of the BOP analog I/O port.
21. Press **F3** - EXTERNAL, **F1** - ZERO to set the BOP to zero volts across the sense resistor (corresponding to zero current). Adjust as needed until the DVM reads as close to zero as possible within the limits specified in Table 4-4 for CURRENT ZERO. Press **F5** twice.
22. Press **F2** - GAIN, **F1** - ZERO to set the BOP to zero volts across the sense resistor (corresponding to zero current). Adjust as needed until the DVM reads as close to zero as possible within the limits specified in Table 4-4 for CURRENT ZERO. Press **F5** twice.
23. Connect  $+10.0V \pm 0.1mV$  d-c reference voltage from the external voltage source to External reference, pin 11, referenced to pin 10 (SGND) of the BOP Analog I/O Port connector (A2A5J6), Press **F2** - GAIN, **F2** - POSITIVE. Measure the current by reading the voltage across the sense resistor. Adjust as needed until the DVM reads as close to zero as possible within the limits specified in Table 4-4 for CURRENT ZERO. Press **F5** twice.
24. Press **F3** - EXTERNAL, **F2** - POSITIVE. Measure the current by reading the voltage across the sense resistor. Adjust as needed until the DVM reads as close as possible above the nominal full scale value within tolerance specified in Table 4-4 for +FULL SCALE CURRENT. Press **F5** three times.
25. Connect the DVM to pin 6 (IOUT\_M\_UNIT) referenced to pin 1 (SGND) of the PAR/SER CONTROL IN connector (A2A5J3). Press **F3** - EXTRL CONTROLS, **F1** - IOUT, and **F1** - ZERO to set the BOP output current to zero. Adjust as needed until DVM reads  $0V \pm 1mV$  d-c. Press **F5** once.
26. Press **F2** - POSITIVE. With DVM still connected to pin 6 (IOUT\_M\_UNIT) referenced to pin 1 (SGND) of the PAR/SER CONTROL IN connector, adjust as needed until DVM reads  $+10V \pm 1mV$  d-c. Press **F5** twice.
27. Save the calibration levels by first using the keys or the **ADJUST** control to enter data such as the calibration date, e.g., 12/21/2004 in the ASCII area of the display. The date entered in this manner is reported in the \*idn? query. Then press **F4** - SAVE.

## 4.5 CALIBRATION STORAGE

The BOP maintains the calibration tables in Flash Memory until a PACK is executed. There are six calibration areas maintained in Flash Memory: Working, Prior, Oldest, Factory, Master, and First.

The calibration can be copied to another area using the CAL:DUMP? and CAL:COPY command. The syntax is as follows: CAL:DUMP? [source];:CAL:COPY [destination], where [source] and [destination] refer to the areas of Flash memory where calibration data is stored, designated as: WORKing, PRIor, OLDest, FACTory, MASTer, FIRst. Source refers to the calibration area that is to be copied, destination to the area that the calibration will be copied into.

The ability to save to the FACTORY area is prohibited. If a user needs to overwrite the factory calibration, a special firmware needs to be created to provide a special password for this capability. Each customer that requests this capability will be provided a password that the company can specify. It must contain at least one alpha, one numeric and one punctuation character (!@#\$\$%^&\*) and be at least 6 characters long and not longer than 20 characters in length. All alpha data must be upper case and no control nor space characters are allowed.

The Master calibration should never be overwritten. Factory, Master, and First are set to the same values when the BOP is calibrated at the factory. The Working calibration is the active calibration. Each time a CAL:SAV is executed, the values are saved in the Working (active) area. At the same time, the values previously stored in Working are moved to Prior, and the values previously stored in Prior are moved to Oldest. The values previously stored in Oldest are no longer available. Table 4-5 illustrates calibration storage and the use of the CAL:DUMP? query and CAL:COPY command.

**TABLE 4-5. CALIBRATION STORAGE**

COMMAND	WORKing	PRIor	OLDest	FACTory	MASTer	FIRst
1. CAL:SAVE	Cal 1 values			Factory cal.	Master cal.	First cal.
2. CAL:SAVE	Cal 2 values	Cal 1 values		No Change	No Change	No Change
3. CAL:SAVE	Cal 3 values	Cal 2 values	Cal 1 values	No Change	No Change	No Change
4. CAL:SAVE	Cal 4 values	Cal 3 values	Cal 2 values	No Change	No Change	No Change
5. CAL:DUMP? FACTory;:CAL:COPY WORKing	Factory cal.	Cal 4 values	Cal 3 values	No Change	No Change	No Change
6. CAL:DUMP? PRIor;:CAL:COPY WORKing	Cal 4 values	Factory cal.	Cal 4 values	No Change	No Change	No Change





## APPENDIX A - SCPI COMMON COMMAND/QUERY DEFINITIONS

### A.1 INTRODUCTION

This appendix defines the SCPI common commands and queries used with the BOP power supply. Common commands and queries are preceded by an asterisk (\*) and are defined and explained in paragraphs A.2 through A.18, arranged in alphabetical order. Table A-1 provides a quick reference of all SCPI common commands and queries used in the Interface Card.

**TABLE A-1. IEEE 488.2 COMMAND/QUERY INDEX**

COMMAND	PAR.	COMMAND	PAR.
*CLS	A.2	*RST	A.11
*ESE, ?	A.3, A.4	*SAV	A.12
*ESR?	A.5	*SRE, ?	A.13, A.14
*IDN?	A.6	*STB?	A.15
*OPC, ?	A.7, A.8	*TRG	A.16
*OPT?	A.9	*TST?	A.17
*RCL	A.10	*WAI	A.18

### A.2 \*CLS — CLEAR STATUS COMMAND

**\*CLS**

Syntax: \*CLS

Description: **Clears status data.** Clears the error queue of the instrument. Forces power supply to “operation complete idle” state. Clears all Event Registers summarized in Status Byte Register without affecting the corresponding Enable Registers: Standard Event Status Register (ESR), Operation Status Event Register, Questionable Status Event Register, and Status Byte Register (STB). Related commands: \*OPC, \*OPC?. (See example, Figure A-1.)

### A.3 \*ESE — STANDARD EVENT STATUS ENABLE COMMAND

**\*ESE**

Syntax: \*ESE <integer> where <integer> = positive whole number: 0 to 255 per Table A-2.  
Default Value: 0

Description: **This command programs the standard Event Status Enable register bits.** The contents function as a mask to determine which events of the Event Status Register (ESR) are allowed to set the ESB (Event Summary Bit) of the Status Byte Register. Enables the Standard events to be summarized in the Status Byte register (1 = set = enable function, 0 = reset = disable function). All of the enabled events of the standard Event Status Enable register are logically ORed to cause ESB (bit 5) of the Status Byte Register to be set (1 = set = enable, 0 = reset = disable). (See example, Figure A-1.)

**TABLE A-2. STANDARD EVENT STATUS ENABLE REGISTER AND STANDARD EVENT STATUS REGISTER BITS**

CONDITION	NU	NU	CME	EXE	DDE	QUE	NU	OPC
BIT	7	6	5	4	3	2	1	0
VALUE	128	64	32	16	8	4	2	1

NU (Not Used)  
 CME Command Error  
 EXE Execution Error  
 DDE Device Dependent Error  
 QUE Query Error  
 OPC Operation Complete

## \*ESE?

### A.4 \*ESE? — STANDARD EVENT STATUS ENABLE QUERY

Syntax: \*ESE?                      Return value: Integer> value per Table A-2.

Description: **Returns the mask stored in the Standard Event Status Enable Register.** Contents of Standard Event Status Enable register (\*ESE) determine which bits of Standard Event Status register (\*ESR) are enabled, allowing them to be summarized in the Status Byte register (\*STB). All of the enabled events of the Standard Event Status Enable Register are logically ORed to cause ESB (bit 5) of the Status Byte Register to be set (1 = set = enable function, 0 = reset = disable function). (See example, Figure A-1.)

## \*ESR?

### A.5 \*ESR? — EVENT STATUS REGISTER QUERY

Syntax: \*ESR?  
Return value: <integer> (Value = contents of Event Status register as defined in Table A-2.)

Description: **Causes the power supply to return the contents of the Standard Event Status register. After it has been read, the register is cleared.** The Standard Event Status register bit configuration is defined in Table A-2 (1 = set, 0 = reset). The error bits listed in Table A-2 are also related to error codes produced during parsing of messages and to errors in the power supply (see PAR. B.159)

- Any 1xx type error sets the Command error bit (5) see.
- Any 2xx type error sets the Execution error bit (4).
- Any 3xx type error sets the Device error bit (3). The Device error bit will be set when Current Error or Voltage Error is detected and the corresponding Status Questionable bit is set (see PAR. B.28).
- Any 4xx type error sets the Query error bit (2).

Related Commands: \*CLS, \*ESE, \*OPC. (See example, Figure A-1.)

## \*IDN?

### A.6 \*IDN? — IDENTIFICATION QUERY

Syntax: \*IDN?  
Return value: Character string

Description: **Identifies the instrument.** This query requests identification. The power supply returns a string which contains the manufacturer name, the model, factory calibration date, serial number and firmware level. The character string contains the following fields separated by commas: <MFR>,<MODEL VOLT-CURR CALDATE>,<SER\_NO.>,<FIRMWARE REV> where <MFR> (manufacturer) = Kepco, <MODEL VOLT-CURR CALDATE> has three subfields: MODEL = BOP2KW, VOLT-CURR = rated voltage and current, and CALDATE = factory calibration date formatted as MM/DD/YYYY (month/day/year). <SER\_NO.> is the 6-digit serial number and <FIRMWARE REV> is the firmware revision. (See example, Figure A-1.)

## \*OPC

### A.7 \*OPC — OPERATION COMPLETE COMMAND

Syntax: \*OPC

Description: **Causes power supply to set status bit 0 (Operation Complete) to “0” indicating the unit is busy. When pending operations are complete this status bit is set to “1.”** This command sets Standard Event Status Register bit 0 (see Table A-2) to “0.” Subsequent \*OPC? commands return “0” until all three microprocessors are idle, indicating that all previous commands have been executed and changes in output level have been completed. When all microprocessors are idle, \*OPC? return “1.” \*OPC? must be preceded by \*OPC to first clear status bit 0, otherwise the \*OPC? will return a “1” that has no meaning. This command does not prevent processing of subsequent commands, but bit 0 will not be set until all pending operations are completed. (1 = set = enable function, 0 = reset = disable function). (See example, Figure A-1.) As an example, the controller sends command(s), then sends \*OPC. If controller then sends \*ESR?, the power supply responds with either a “0” (if the power supply is busy executing the programmed commands), or a “1” (if the previously programmed commands are complete). (See example, Figure A-1.)

# \*OPC?

## A.8 \*OPC? — OPERATION COMPLETE QUERY

Syntax: \*OPC?  
Return value: <1 or 0> (ASCII)  
0 placed in output queue if power supply has not completed operation after prior \*OPC command.  
1 placed in output queue when power supply has completed operation.

Description: **Indicates when pending operations have been completed.** \*OPC command must be sent first to clear status bit 0 (Operation Complete). \*OPC? will return "0" until all pending operations are complete (all previous commands have been executed and changes in output level have been completed) At that time \*OPC? will return "1." Unlike the \*WAI command (see PAR. A.18), subsequent commands are not inhibited while status bit 0 is "0." \*OPC? is intended to be used at the end of a command line so that the application program can monitor the bus for data until it receives the "1" from the power supply Output Queue. (See example, Figure A-1.)

*CLS	Power supply clears status data.
*ESE 60	Power supply enables bits 5, 4, 3 and 2, allowing command error, execution error, device dependent error and query error to set the Event Status Summary bit when an STB command is executed.
*ESE?	Returns 60, (value of the mask) verifying that bits 5, 4, 3 and 2 are enabled.
*ES	Unknown command will set command error (Bit 5).
*ESR?	Returns 33 (bit 5 set), indicating Command Error has occurred since the last time the register was read. Bit 1 indicates operation complete (OPC).
*IDN?	Power supply returns: KEPCO,BOP2KW 36-28 09/30/2001,123456,4.01
*OPC	Allows status bit 0 to be set when pending operations complete.
OUTP ON;:VOLT 21;CURR 3;*WAI;*OPC?	If unit is in voltage mode, sets output voltage to 21V, output current protection limit to 3A. *OPC? will return a 1 indicating the command has been processed by the BOP.
*ESR?	Returns 1, (operation complete, bit 1 = 1).
*ESR?	Returns 0 (event status register cleared by prior *ESR?).
VOLT 15;CURR 5;*OPC?	Sets output voltage to 15V, output current protection limit to 5A, puts "1" on output bus when command operations are complete.
*RST	Power supply reset to power on default state including TRIG:SOUR IMM.
*SRE 40	When ESB or QUES bits are set (Table A-3), the Request for Service bit will be set.
*SRE?	Returns the value of the mask (40).
*STB?	For example, the Power supply responds with 96 (64 + 32) if MSS and the Event Status Byte (Table A-3) summary bit have been set. The power supply returns 00 if no bits have been set.
OUTP ON	Programmed voltage will be applied to output terminals.
VOLT 25	Power supply voltage commanded to 25V.
*WAI	Next command (VOLT:TRIG 12) cannot be executed until VOLT 25 is complete.
TRIG:SOUR BUS	Selects *TRG commands to be used to trigger the unit.
VOLT:TRIG 12	Programs power supply voltage to 12V when *TRG received.
INIT	Trigger event is initialized.
*TRG	Power supply reverts to commanded output voltage of 12V. ** LOAD DISCONNECTED
*TST?	Power supply executes self test and responds with 0 if test completed successfully, with 1 if test failed.

FIGURE A-1. GPIB COMMANDS

# \*OPT?

## A.9 \*OPT? — OPTIONS QUERY

Syntax: \*OPT?  
Returns string determined by power supply model.

Description: **Causes the power supply to return an ASCII string which defines the functionality of the power supply.** The functionality is defined as follows:

STRING DATA	MEANING
CCAL	Support for limit calibrations is present.
RL1	Commands sent over GPIB cause unit to enter remote mode.
MEMM	Computer location commands are supported.
CALPR	Calibrate for protection steps.
LSTAPL	LIST Apply command is supported.

## A.10 \*RCL — RECALL COMMAND

# \*RCL

Syntax: \*RCL <integer> (1 to 99)

Description: **Restores power supply to previously defined levels of output voltage, output current and triggers.** This command selects one of the 99 power supply memory locations, each of which stores values for output current and output voltage. Executing a \*RCL recalls the stored settings (see \*SAV, PAR. A.12, for details) from the specified location (whether stored locally or using SCPI commands) and applies them to the unit.

## A.11 \*RST — RESET COMMAND

# \*RST

Syntax: \*RST

Description: **Resets power supply.** Executing \*RST has the following effects:

- Stops any LIST command that is running
- CURR:MODE (PAR B.35) and VOLT:MODE (PAR B.111) are both set to FIXed (transient is inactive)
- VOLT:PROT (PAR B.113) and CURR:PROT (PAR B.37) are both set to box values.
- VOLT (PAR B.103) and CURR (PAR B.27) settings are both set to 0.
- VOLT:PROT:MODE (PAR B.115) and CURR:PROT:MODE (PAR B.39) are both set to FIXed
- FUNC:MODE (PAR B.53) is set to VOLTage
- TRIG:SOUR (PAR B.181) set to BUS
- CURR:TRIG (PAR B.51) and VOLT:TRIG (PAR B.127) both set to 0
- FUNC:MODE:TRIG (PAR B.55) set to VOLTage
- INIT:CONT (PAR B.6) set to OFF (trigger system is not armed)
- Output set to either on or off, as determined by setting of **\*RST set Output** from Interface settings menu (see Table 3-17 and PAR. 3.5.3.3).

# \*SAV

## A.12 \*SAV — SAVE COMMAND

Syntax: \*SAV <integer> (1 to 99)

Description: **Saves the present state of output voltage and output current to the specified memory location.** This command stores the present state of the power supply to one of 99 memory locations in Flash Memory (see PAR. 3.6.3.6). The following parameters are stored by \*SAV: FUNC:MODE, VOLT:MODE, CURR:MODE, VOLT:PROT, and CURR:PROT. Settings stored are:

- Mode of operation (Voltage, Current or External) FUNC:MODE < >
- Main channel reference type (internal or external) and setting (if internal) VOLT:MODE < > or CURR:MODE < >, VOLT < > or CURR < >
- Protection channel reference type (internal or external) and setting (if internal) VOLT:PROT:MODE < > or CURR:PROT:MODE < >, VOLT:PROT < > or CURR:PROT < >
- Output status (on or off) OUP < >

The stored values can be restored by the \*RCL command. See PAR. 3.5.2.2 and Figure 3-17 for special programming considerations.

# \*SRE

## A.13 \*SRE — SERVICE REQUEST ENABLE COMMAND

Syntax: \*SRE<integer> where <integer> = value from 0 - 255 per Table A-3, except bit 6 cannot be programmed.

Description: **Sets the condition of the Service Request Enable register.** The Service Request Enable register determines which events of the Status Byte Register are summed into the MSS (Master Status Summary) and RQS (Request for Service) bits. RQS is the service request bit that is cleared by a serial poll, while MSS is not cleared when read. A "1" (1 = set = enable, 0 = reset = disable) in any Service Request Enable register bit position enables the corresponding Status Byte bit to set the RQS and MSS bits. All the enabled Service Request Enable register bits then are logically ORed to cause Bit 6 of the Status Byte Register (MSS/RQS) to be set. Related Commands: \*SRE?, \*STB?. (See example, Figure A-1.)

TABLE A-3. SERVICE REQUEST ENABLE AND STATUS BYTE REGISTER BITS

CONDITION	OPER	MSS RQS	ESB	MAV	QUES	ERR QUE	LIST RUN	BUSY
BIT	7	6	5	4	3	2	1	0
VALUE	128	64	32	16	8	4	2	1

BUSY Busy  
LIST RUN List is running  
OPER Operation Status Summary  
MSS Master Status Summary  
RQS Request for Service  
ESB Event Status Byte summary  
MAV Message available  
QUES QUESTIONable Status Summary  
ERR QUE 1 or more errors occurred (see PAR. B.159)

## A.14 \*SRE? — SERVICE REQUEST ENABLE QUERY

# \*SRE?

Syntax: \*SRE? Response: <integer> = value from 0 - 255 per Table A-3.

Description: **Reads the Service Enable Register.** Used to determine which events of the Status Byte Register are programmed to cause the power supply to generate a service request (1 = set = function enabled, 0 = reset = function disabled). Related Commands: \*SRE, \*STB? (See example, Figure A-1.)

## A.15 \*STB? — STATUS BYTE REGISTER QUERY

# \*STB?

Syntax: \*STB? Response: <integer> value from 0 to 255 per Table A-3.

Description: **Reads Status Byte Register without clearing it.** This Query reads the Status Byte Register (bit 6 = MSS) without clearing it (1 = set = function enabled, 0 = reset = function disabled). The register is cleared only when subsequent action clears all set bits. MSS is set when the power supply has one or more reasons for requesting service. (A serial poll also reads the Status Byte Register, except that bit 6 = RQS, not MSS; and RQS will be reset.) Related Commands: \*SRE, \*SRE?. (See example, Figure A-1.)

# \*TRG

## A.16 \*TRG — TRIGGER COMMAND

Syntax: \*TRG

Description: **Triggers the power supply to be commanded to preprogrammed values of output current and voltage.** When the trigger is armed, \*TRG generates a trigger signal if TRIG:SOUR is set to BUS and the WTG bit in Status Operational Condition register (bit 5, Table B-4) is asserted. The trigger is armed by sending a) INIT:CONT ON to continuously arm the trigger and allow subsequent \*TRG commands to generate the trigger signal or b) if INIT:CONT is set to OFF, sending INIT arms the system and allows a \*TRG to generate a single trigger. If \*TRG is received while the trigger is not armed, the trigger is not produced and no error is generated.

The trigger will change the output of the power supply to the output voltage and current levels specified by VOLT:TRIG and CURR:TRIG commands and clear the WTG bit in the Status Operation Condition register. If INIT:CONT 1 (ON) has been issued, the trigger subsystem is immediately rearmed for subsequent triggers, and the WTG bit is again set to 1. \*TRG or GET are both addressed commands (only devices selected as listeners will execute the command). If output is set to OFF, \*TRG is ignored. Related Commands: ABOR, INIT, TRIG, CURR:TRIG, VOLT:TRIG. (See example, Figure A-1.)

## A.17 \*TST? — SELF TEST QUERY

# \*TST?

Syntax: \*TST? Returned value: 7 bits coded per Table A-4.

Description: **Power Supply test.** This query causes the power supply to do a self test and provide the controller with pass/fail results. A 0 is returned if the unit passes the test. If the unit fails, a number from 1 through 128 is returned to indicate the cause of the error. The test executes each of the subtests even when any one fails. If any test fails an error code bit is set which is returned to the user. The error codes returned are listed in Table A-4

TABLE A-4. BUILT-IN TEST ERROR CODES

TEST ACTIVE		ERROR CODES		MEANING
*tst?	DIAG:TST?	BIT	VALUE	
Yes	Yes		0	Pass (No error)
Yes	Yes	0	1	ROM error
Yes	Yes	1	2	RAM error
Yes	Yes	2	4	FLASH error -- Perform calibration to correct
Yes	Yes	4	16	Analog Communication error
No	Yes	5	32	Loop Back Test error
No	Yes	6	64	Max Voltage Output error
No	Yes	7	128	Min Voltage Output error

## A.18 \*WAI — WAIT-TO-CONTINUE COMMAND

# \*WAI

Syntax: \*WAI Response:

Description: **Causes the power supply to wait until all previously issued commands and queries are complete before executing subsequent commands or queries.** This command can be used to guarantee sequential execution of commands and queries. When used in a command string involving a setpoint change and if MEAS:MODE SYNC is set prior to the setpoint change, \*WAI ensures the setpoint data is valid before allowing the next command in the string to be executed.

## APPENDIX B - SCPI COMMAND/QUERY DEFINITIONS

### B.1 INTRODUCTION

This appendix defines the SCPI subsystem commands and queries used with the BOP power supply. Subsystem commands are defined in PAR. B.3 through B.182, arranged in groups as they appear in the tree diagram, Figure 3-24. Table B-1 provides a quick reference of all SCPI subsystem commands and queries used in the BOP.

**TABLE B-1. SCPI SUBSYSTEM COMMAND/QUERY INDEX**

COMMAND	PAR.	COMMAND	PAR.
ABOR	B.3	[SOUR:]FUNC:MODE, ?	B.53, B.54
CAL	B.4	[SOUR:]FUNC:MODE:TRIG, ?	B.55, B.56
INIT[:IMM]	B.5	[SOUR:]LIST:CLE	B.57
INIT:CONT, ?	B.6, B.7	[SOUR:]LIST:COPY	B.58
MEAS?	B.8	[SOUR:]LIST:COUN, ?	B.59, B.60
MEAS:CURR?	B.9	[SOUR:]LIST:COUN:SKIP, ?	B.61, B.62
MEAS:MODE, ?	B.10, B.11	[SOUR:]LIST:CURR, ?	B.63, B.64
MEAS:RATE, ?	B.12, B.13	[SOUR:]LIST:CURR:APPL	B.65
MEAS:VOLT?	B.14	[SOUR:]LIST:CURR:APPL:SWE, ?	B.66, B.67
MEAS:TRAN?	B.15	[SOUR:]LIST:POIN?	B.68
MEM:LIST?	B.16	[SOUR:]LIST:DIV, ?	B.70, B.71
MEM:LOC, ?	B.17, B.18	[SOUR:]LIST:DWEL, ?	B.72, B.73
MEM:PACK	B.19	[SOUR:]LIST:DWEL:POIN?	B.74
MEM:UPD	B.20	[SOUR:]LIST:ERAS	B.75
OUTP[:STAT], ?	B.21, B.22	[SOUR:]LIST:QUER, ?	B.76, B.77
OUTP:CONT ?	B.23, B.24	[SOUR:]LIST:REC	B.78
OUTP:MODE, ?	B.25, B.26	[SOUR:]LIST:REP	B.79
[SOUR:]CURR, ?	B.27, B.28	[SOUR:]LIST:RES?	B.80
[SOUR:]CURR:LIM[:BOTH], ?	B.29, B.30	[SOUR:]LIST:SAMP:CURR	B.81
[SOUR:]CURR:LIM:NEG, ?	B.31, B.32	[SOUR:]LIST:SAMP:VOLT	B.82
[SOUR:]CURR:LIM:POS, ?	B.33, B.34	[SOUR:]LIST:SAMP?	B.83
[SOUR:]CURR:MODE, ?	B.35, B.36	[SOUR:]LIST:SEGM, ?	B.84, B.85
[SOUR:]CURR:PROT[:BOTH], ?	B.37, B.38	[SOUR:]LIST:SET:SAMP, ?	B.86, B.87
[SOUR:]CURR:PROT:MODE, ?	B.39, B.40	[SOUR:]LIST:SAVE	B.88
[SOUR:]CURR:PROT:NEG, ?	B.41, B.42	[SOUR:]LIST:SET:TRIG, ?	B.89, B.90
[SOUR:]CURR:PROT:POS, ?	B.43, B.44	[SOUR:]LIST:SET:WAIT, ?	B.91, B.92
[SOUR:]CURR:PROT:LIM[:BOTH], ?	B.45, B.46	[SOUR:]LIST:TRIG:	B.93
[SOUR:]CURR:PROT:LIM:NEG, ?	B.47, B.48	[SOUR:]LIST:VOLT, ?	B.94, B.95
[SOUR:]CURR:PROT:LIM:POS, ?	B.49, B.50	[SOUR:]LIST:VOLT:APPL	B.96,
[SOUR:]CURR:TRIG, ?	B.51, B.52	[SOUR:]LIST:VOLT:APPL:SWE, ?	B.97, B.98

NOTE: Commands listed above that are followed by “, ?” have a related query.

**TABLE B-1. SCPI SUBSYSTEM COMMAND/QUERY INDEX (CONTINUED)**

COMMAND	PAR.	COMMAND	PAR.
		[SOUR:]LIST:VOLT:POIN?	B.99
[SOUR:]LIST:WAIT:HIGH	B.100	SYST:COMM:LAN:DHCP, ?	B.143, B.144
[SOUR:]LIST:WAIT:LEDG	B.101	SYST:COMM:LAN:IP, ?	B.145, B.146
[SOUR:]LIST:WAIT:LOW	B.103	SYST:COMM:LAN:MAC?	B.147
[SOUR:]VOLT, ?	B.103, B.104	SYST:COMM:LAN:MASK, ?	B.148, B.149
[SOUR:]VOLT:LIM[:BOTH], ?	B.105, B.106	SYST:COMM:LAN:LRST	B.150
[SOUR:]VOLT:LIM:NEG, ?	B.107, B.108	SYST:COMM:SER:BAUD, ?	B.151, B.152
[SOUR:]VOLT:LIM:POS, ?	B.109, B.110	SYST:COMM:SER:ECHO, ?	B.153, B.154
[SOUR:]VOLT:MODE, ?	B.111, B.112	SYST:COMM:SER:PACE, ?	B.155, B.156
[SOUR:]VOLT:PROT[:BOTH], ?	B.113, B.114	SYST:COMM:SER:PROM, ?	B.157, B.158
[SOUR:]VOLT:PROT:MODE, ?	B.115, B.116	SYST:ERR?	B.159
[SOUR:]VOLT:PROT:NEG, ?	B.117, B.118	SYST:ERR:CODE? ALL?	B.160, B.161
[SOUR:]VOLT:PROT:POS, ?	B.119, B.120	SYST:KEYB, ?	B.162, B.163
[SOUR:]VOLT:PROT:LIM[:BOTH], ?	B.121, B.122	SYST:MDNS?	B.164
[SOUR:]VOLT:PROT:LIM:NEG, ?	B.123, B.124	SYST:MDNS:IND, ?	B.165, B.166
[SOUR:]VOLT:PROT:LIM:POS, ?	B.125, B.126	SYST:MDNS:NAME, ?	B.167, B.168
[SOUR:]VOLT:TRIG	B.127, B.128	SYST:MODE, ?	B.169, B.170
STAT:OPER:COND?	B.129	SYST:PASS:CEN	B.171
STAT:OPER:ENAB, ?	B.130, B.131	SYST:PASS:CDIS	B.172
STAT:OPER[:EVEN]?	B.132	SYST:PASS:NEW	B.173
STAT:PRES	B.133	SYST:PASS:STAT	B.174
STAT:QUES[:EVEN]?	B.134	SYST:REM, ?	B.175, B.176
STAT:QUES:COND?	B.135	SYST:SEC:IMM	B.177
STAT:QUES:ENAB, ?	B.136, B.137	SYST:SET, ?	B.178, B.179
SYST:BEEP	B.138	SYST:VERS?	B.180
SYST:COMM:GPIB:ADDR, ?	B.139, B.140	TRIG:SOUR, ?	B.181, B.182
SYST:COMM:LAN:AUTO, ?	B.141, B.142		

NOTE: Commands listed above that are followed by “, ?” have a related query.



## B.2 NUMERICAL VALUES

For all **decimal** values the SCPI data parser of the BOP supports a maximum of eight digits after the decimal point and a maximum of four digits before the decimal point. For example: If volt 10345.2e-1 is processed, the output will become 34.52 volts because the unit only recognizes the first four digits preceding the decimal point. Sending volt 0.0000034567e6 will result in the output being set to 3.45 volts because the unit only recognizes the first eight digits after the decimal point.

The unit can process any number between 6500.9999 and .000001. Any values greater than these are not processed by the device and a "120 - numeric data error" (see Table B-6) is generated. The largest string that can be received or transmitted by the BOP is 253 characters. All numerical data is returned in scientific notation, digits with decimal point and Exponent, e.g., 2.71E1 for 27.1.

The unit also supports keywords of MAXimum and MINimum to set the numeric entry to the most positive and negative allowable values, respectively. For example, If the user has established the volt:limit to be 6, sending the command VOLT MAX causes the output to be set to 6 volts. This syntax can be very useful in the setting of a limit, e.g., VOLT:PROT:LIM MAX sets the positive voltage protection limit to the maximum voltage ( $E_{Omax} + 1\%$ ) and the negative voltage protection limit to  $(-1.01 \times E_{Omax})$ .

## B.3 ABORt COMMAND

## ABOR

Syntax: Short Form: ABOR Long Form: ABORt

Description: **Cancels previously armed trigger, resets WTG.** If the trigger system is armed (INIT:CONT set to OFF and INIT sent), sending ABORt disarms the trigger system so subsequent trigger commands have no effect. If INIT:CONT ON has been programmed, this command has no effect. Related Commands: INIT, \*TRG. (See example, Figure B-1.)

## B.4 CAL COMMANDS AND QUERIES

## CAL

CAL commands and queries are used to perform calibration of the unit via the control interface. These commands must be issued in a specific sequence in order to properly calibrate the unit. To use these commands, refer to Kepco's website ([www.kepcopower.com/drivers](http://www.kepcopower.com/drivers)) and download the LabWindows/CVI Version 5 driver for BOP or refer to PAR. 4.3. This file provides remote calibration capability and uses the following supported commands and queries:

CAL:CEXT command	CAL:STAT command and query
CAL:CGA command	CAL:VEXT command
CAL:CLIM command	CAL:VGA command
CAL:CPR command	CAL:VLIM command
CAL:CURR[:DATA] command	CAL:VOLT[:DATA] command
CAL:DATA value command	CAL:VPR command
CAL:DPOT command	CAL:ZERO command
CAL:SAVE command	

## B.5 INITiate[:IMMediate] COMMAND

## INIT[:IMM]

Syntax: Short Form: INIT:[IMM] Long Form: INITiate[:IMMediate]

Description: **Enables a single trigger.** This command enables a single trigger. A \*TRG command completes the sequence, however TRIG:SOUR (see PAR. B.181) must be set to BUS. Upon receipt of the \*TRG command, the power supply will return to the commanded values of voltage and current established by the VOLT:TRIG and CURR:TRIG commands. After a \*TRG command has been received, subsequent \*TRG commands have no effect unless preceded by INIT or INIT:CONT ON. Related Commands: \*TRG, TRIG, TRIG:SOUR. (See example, Figure B-1.)

- NOTES: 1. The power supply is assumed to be operating in constant voltage mode.  
 2. Examples below are intended only to illustrate command functions. Refer to PAR. 3.5.2 for programming techniques to optimize performance.

OUTP ON	Turns the output on.
VOLT 21; CURR 1.5	Power supply output programmed to go to 21V, current limit 1.5A
INIT:CONT ON	Continuous triggers enabled.
INIT:CONT?	Power supply returns "1."
TRIG:SOUR BUS	Prepare unit to wait for *TRG.
VOLT:TRIG 15;CURR:TRIG 3	Power supply output programmed to return to 15V, current limit 3A upon receipt of trigger.
*TRG	Power supply output returns to 15V,current limit 3A.
VOLT 21; CURR 5E-2	Power supply output programmed to go to 21V, current limit 0.05A
MEAS:VOLT?	If actual value of output voltage is 20.99V, power supply returns 2.099E1 within the limits of readback accuracy.
MEAS:CURR?	If actual value of output current is 0.0499A, power supply returns 4.99E-2 within the limits of readback accuracy.
FUNC:MODE CURR	Establishes constant current mode as power supply operating mode.
VOLT 21; CURR 1.1	Power supply programmed to voltage limit 21V, 1.1A.
CURR?	Returns 1.1.
FUNC:MODE VOLT	Establishes constant voltage mode as power supply operating mode.
CURR:TRIG?	Returns 3 (current value established by CURR:TRIG).
VOLT:TRIG?	Returns 15 (voltage value established by VOLT:TRIG).
*TRG	Power supply output returns to 15V, current limit 3A.
INIT:CONT 0	Triggers disabled.
INIT:CONT?	Power supply returns "0."
VOLT 0	Power supply output programmed to go to 0V.
MEAS:VOLT?	Returns 0 within the limits of readback accuracy (measured output voltage).
VOLT?	Returns 0 within the limits of readback accuracy (programmed output voltage).
CURR?	Returns 3 (programmed current).
MEAS:CURR?	Returns 0 within the limits of readback accuracy (measured output current).

FIGURE B-1. PROGRAMMING THE OUTPUT

## B.6 INITiate:CONTinuous COMMAND

## INIT:CONT

Syntax: Short Form: INIT:CONT {ON | OFF} or {1 | 0} (1 = on, 0 = off)  
 Long Form: INITiate:CONTinuous {ON | OFF} or {1 | 0} (1 = on, 0 = off)

Description: **INIT:CONT ON enables continuous triggers.; INIT:CONT OFF disables continuous triggers.** If INIT:CONT is OFF, then INIT[:IMM] arms the trigger system for a single trigger. If INIT:CONT is ON, then the trigger system is continuously armed and INIT[:IMM] is redundant. While INIT:CONT is ON, WTG (bit 5 of the Operation Status Condition register (See Table B-4) is always 1 if the TRIG:SOUR is BUS. If TRIG:SOUR is set to EXT, WTG is reset to 0 when the trigger is generated, then set to 1 automatically by the unit. Unlike the BUS trigger source, the transitions in WTG status can be captured by setting WTG (bit 5) in the Status Operation Enabled Register to cause the WTG bit to be set in the Status Operation Event register. (See example, Figure B-1.) Executing \*RST sets the init:cont state to 0 or off and clears the WTG bit in the STATUS OPERATION REGISTER.

## B.7 INITiate:CONTinuous? QUERY

## INIT:CONT?

Syntax: Short Form: INIT:CONT? Long Form: INITiate:CONTinuous?  
 Return Value: 1 or 0

Description: **Determines whether continuous triggers are enabled or disabled.** Power supply returns value of INIT:CONT flag: "1" = continuous triggers are enabled (INIT:CONT ON); "0" = continuous triggers disabled (INIT:CONT OFF). (See example, Figure B-1.)

# MEAS?

## B.8 MEASure? QUERY

Syntax: Short Form: MEAS? Long Form: MEASure?  
 Return Value: <exp\_value> = digits with decimal point and Exponent, e.g., 2.71E1 for 27.1  
 VVVV,CCCC,STAT where  
 VVVV = measured voltage  
 CCCC = measured current  
 STAT = status (see Table B-2)

Description: **Measures actual voltage and current without sending separate MEAS:VOLT? and MEAS:CURREN? queries.** This query returns the actual value of output voltage and current as determined by the programmed value of voltage and current and load conditions.

**TABLE B-2. MEAS? QUERY STATUS BYTE REGISTER BITS**

CONDITION	N/A	N/A	FAULT	PROT	MODE	ERR QUE	LIST RUN	OUTPUT STATE	
BIT	7	6	5	4	3	2	1	0	
VALUE	128	64	32	16	8	4	2	1	

FAULT Unit is not operating and is not delivering power. Front panel FAULT indicator is ON (see Table 3-1)  
 PROT Unit displays VPROTECT, CPROTECT or PROTECT  
 MODE 0 = Voltage Mode, 1 = Current Model (see PARs 1.2, B.53)  
 ERR QUE One or more errors occurred (see PAR. B.161)  
 LIST RUN List is running  
 OUTPUT Output is on.

## B.9 MEASure:CURREN? QUERY

Syntax: Short Form: MEAS:CURREN?  
 Long Form: MEASure:CURREN?  
 Return Value: <num\_value> (digits with decimal point and Exponent)

Description: **Measures actual current.** This query returns the actual value of output current as determined by the programmed value of voltage and current and load conditions. (See example, Figure B-1.)

# MEAS:CURREN?

## B.10 MEASure:MODE COMMAND

Syntax: Short Form: MEAS:MODE {SYNC | ASYN}  
 Long Form: MEASure:MODE {SYNChronous | ASYNchronous}

Description: **Determines measurement sampling rate.** SYNC establishes a connection between a setpoint change and the measurement system, providing the ability to measure the output after a change with a guarantee of an update within 60 milliseconds. ASYN is the power up setting and allows for a free running measurement system that can attain a 25 millisecond measurement setpoint rate though there is no guarantee that measurements match each setpoint change.

NOTE: MEAS:MODE syntax (similar to MEAS:RATE command, see PAR. B.12 for details) found in previous Firmware versions is still supported.

# MEAS:MODE

## B.11 MEASure:MODE? QUERY

Syntax: Short Form: MEAS:MODE?  
 Long Form: MEASure:MODE?  
 Return Value: SYNC or ASYN

Description: **Indicates whether measurements are synchronous or asynchronous.** Returns SYNC or ASYN to indicate whether the measurements are synchronized with setpoint changes or not.

# MEAS:MODE?

## B.12 MEASure:RATE COMMAND

Syntax: Short Form: MEAS:RATE <int\_value 50 or 60 or 100>  
 Long Form: MEASure:RATE <int\_value 50 or 60 or 100>

Description: **Determines measurement sampling rate.** Value of 50, 60, or 100 and represents the sampling rate (Hz) for measurements (MEAS:VOLT? and MEAS:CURREN?). The meters LCD display normally uses a 60 Hertz sample rate, creating a sample of 1 cycle in length or 16.6 mS. The 50 Hz sample rate (20 mS sample) is used to display the slower graphic selections on the meter display, The 100 Hz sample rate (10 mS sample) is used for the three fastest graphic display selections. Upon power-up this value is set to 60 or 100, based upon the settings for metered display.

# MEAS:RATE

### B.13 MEASure:RATE? QUERY

## MEAS:RATE?

Syntax: Short Form: MEAS:RATE?  
Long Form: MEASure:RATE?  
Return Value:50, 60 or 100)

Description: **Indicates measuring rate.** This query returns the sampling rate established by MEAS:RATE command, either 50, 60 or 100 Hz.

### B.14 MEASure:VOLTage? QUERY

## MEAS:VOLT?

Syntax: Short Form: MEAS:VOLT?  
Long Form: MEASure:VOLTage?  
Return Value: <num\_value> (digits with decimal point and Exponent)

Description: **Measures actual voltage.** This query returns the actual value of output voltage (measured at the sense terminals) as determined by the programmed value of voltage and current and load conditions. (See example, Figure B-1.)

### B.15 MEASure:TRANSient? QUERY

## MEAS:TRAN?

Syntax: Short Form: MEAS:TRAN? Long Form: MEASure:TRANSient?  
Returns <exp\_value>,<exp\_value>,. . . <exp\_value>

Description: **Returns measured sample.** Value returned represents either current or voltage depending on previous LIST. Up to eight comma-separated values may be returned. (See Figures B-3 and B-4.)

### B.16 MEMory:LIST? QUERY

## MEM:LIST?

Syntax: Short Form: MEM:LIST? <n> Long Form: MEMory:LIST? <n>  
where <n> is segment number of a waveform loaded into memory by LIST:RECall command  
Returns <type>,<value1>,<value2>[,<value3>],<value4>,<value5>]  
Where <type> is {SQUARE | RAMP+ | RAMP- | TRIANGLE | SINE | LEVEL}  
<value1> is frequency (or period (duration) for level)  
<value2> is p-p amplitude (or amplitude (offset) for level)  
<value3> is offset (optional, default is 0, not applicable to level)  
<value4> = starting point for sine and triangle segments. only returned if type = sine or triangle and both start and stop angle are not 0° or 360°  
<value5> = stopping point for sine and triangle segments. only returned if type = sine or triangle and both start and stop angle are not 0° or 360°

Description: **Returns parameters for segment specified by <n> that has been loaded into memory by LIST:REC command.** This query can be used to verify waveform parameters, segment by segment, before execution. If there are only 5 segments in a waveform, and a MEM:LIST? 6 query is sent, there will be no response, and the error queue will indicate an error.

### B.17 MEMory:LOCation COMMAND

## MEM:LOC

Syntax: Short Form: MEM:LOC xx,<MODE>,<Vsetpoint>,<Csetpoint>,<Pprotect>,<Nprotect>,<ON OFF>,<V/C Mode>,<V/C Protect Mode>  
Long Form: MEMory:LOCation xx,<MODE>,<Vsetpoint>,<Csetpoint>,<Pprotect>,<Nprotect>,<ON OFF>,<V/C Mode>,<V/C Protect Mode>

where:

xx	= memory locations (01 through 99)
<Mode>	= VOLTage, CURRent, or EMODe
<Vsetpoint>	= Voltage setting in voltage mode
<Csetpoint>	= Current setting in current mode
<Pprotect>	= Positive protection value
<Nprotect>	= Negative protection value
<Output>	= Output state ON or OFF
<V/C Mode>	= FIXed, EXTernal, or GAIN
<V/C Protect Mode>	= PFIxed, PEXTernal or PLESser

Description: **Populates a memory location with operating parameters that can be loaded quickly.** The actual output of power supply does not change when this command is executed. Implementing the stored parameters requires the use of the \*RCL command (PAR. A.10). Following the 2-digit memory location are eight comma-separated parameters. All parameters must appear in the exact order listed. The parameters have the following functions:

<Mode>= Determines the operating mode of the power supply: VOLT for voltage mode, CURR for current mode or EMODE for external programming mode (where operating mode (either voltage or current mode) is controlled by a signal on a single pin. (Same as FUNC:MODE or MODE command, see PAR. B.53, NOTE: EMODE is the same as FUNC:MODE EXT.)

<Vsetpoint>= Numerical value determines the voltage output in voltage mode.

<Csetpoint>= Numerical value determines the current output in current mode.

<Pprotect>= **In voltage mode or current mode:** Numerical value of VOLT:PROT POS in current mode or CURR:PROT POS in voltage mode

**In EMODE:** Numerical value establishes both the positive and negative protection limits for current. (Same as CURR:PROT command, see PAR. B.37.)

<Nprotect>= **In voltage mode or current mode:** Numerical value of VOLT:PROT NEG in current mode or CURR:PROT NEG in voltage mode

**In EMODE:** Numerical value establishes both the positive and negative protection limits for voltage. (Same as VOLT:PROT command, see PAR. B.113.)

<Output>= Determines whether the output is ON or OFF (Same as OUP command, see PAR. B.21.)

<V/C Mode>= Determines whether control is by the internal reference (FIXed) or by an external reference. Similar to VOLT:MODE (see PAR. B.113 for voltage mode or CURR:MODE (see PAR. B.35 for current mode). EXT - configures the unit to use an external reference to change the main channel, whether voltage or current.

GAIN - Configures the unit to use an external reference to provide a proportional output voltage.

ADD - Sums the external reference with either the internal reference produced from CURR or VOLT commands in remote mode, or front panel controls in local mode.

<V/C Protect Mode>= Determines how voltage or current protection limits are controlled in voltage or current mode of operation. Similar to VOLT:PROT:MODE (see PAR. B.113) for voltage mode or CURR:PROT:MODE (see PAR. B.39) for current mode.

PFIXed - Allows the limits to be controlled by digital signals from either the keypad (if the unit is in local mode) or SCPI command (if the unit is in remote mode).

PEXTernal - Allows both current and voltage limits to be controlled by analog signals applied to the analog port; limits set from the keypad or SCPI command have no effect

PLESSer Allows protect limit to be automatically selected from either 1) an external analog voltage applied to the Analog I/O port or 2) the value set from the either the keypad (local mode) or by SCPI command (remote mode). Whichever limit has a lower absolute value (closest to zero) has effect

When this command is executed, all setpoints and limits are first set to 0's and the current mode and output on/off states are written to location xx. Then any data provided overwrites the existing value of this parameter. This allows for simpler syntax when setting parameters to 0 by simply omitting the data for that parameter. To set current setpoint and voltage protect settings to 0, sending MEM:LOC 10,VOLT,10,,,4,,,ON is sufficient. (See example, Figure B-2.)

## B.18 MEMory:LOCation? QUERY

## MEM:LOC?

Syntax: Short Form: MEM:LOC? xx

Long Form: MEMory:LOCation xx

Return Value: <MODE>,<VSetpoint>,<Csetpoint>,<Pprotect>,<Nprotect>,<ON OFF><V/C Mode>,<V/C Protect Mode>

Description: **Returns the settings for the location xx (01 through 99).** Numerical values returned represent, in order, <VSetpoint>,<Csetpoint>,<Pprotect>,<Nprotect>. See PAR. B.17 for parameter definitions. (See example, Figure B-2.)

VOLT 5;CURR .5	Voltage/current setpoints set to 5 Volts/0.5 Amperes, respectively
curr:prot 1;;volt:prot 14	Current protect set to 1 Ampere. Voltage protect set to 14 Volts.
MODE VOLT;;outp on	Causes the BOP/BIT to output 5 Volts at up to 1 Ampere in voltage mode.
*SAV4	Saves the six values in location 4 of the SAV memory area.
FUNC:MODE CURR	Causes the output to go to 0.5 Amperes. Assuming a load of 5 ohms, the voltage measured at the output will be 2.5 Volts.
MEM:LOC? 4	Unit returns VOLT,5,0.5,FIX,1,14,FIX,ON.
mem:Loc 10,VOLT,10,3,,4,5,,ON	Causes the settings to be stored in location 10.
*RCL 10	Immediately sets the unit to voltage mode @ 10 Volts with current protection of 4 Amperes with output on.
MODE CURR	Would sets current level to 3 Amperes and Voltage protection to 5 volts.

**FIGURE B-2. USING MEMORY LOCATION COMMANDS AND QUERIES**

### B.19 MEMory:PACK COMMAND

## MEM:PACK

Syntax: Short Form: MEM:PACK Long Form: MEMory:PACK

Description: **Compresses flash memory.** When the memory is out of space, the internal microprocessor copies the live data to a backup flash area, erases the main flash data area, copies the current control variables into this clean space and then erases the backup flash area. The pack process can take 500 milliseconds to complete. Refer to PAR. 3.6.3.6 for MEM:PACK details

### B.20 MEMory:UPDate COMMAND

## MEM:UPD

Syntax: Short Form: MEM:UPD {INT | LIM | SER | CONT | OUTP}  
Long Form: MEMory:UPDate {INTerface | SERial | LIMits | CONTRast | OUTPut}

Description: **Saves selected variables.** MEM:UPD INT saves GPIB address, Language (SCPI or CIIL), SYST:SET (PAR. B.178) variables and the state of OUTP:CONT (see PAR. B.23). MEM:UPD SER saves the serial communication state, baud rate, pace control and echo information. MEM:UPD LIM saves limits for voltage and current and the maximum allowable protection values for voltage and current. MEM:UPD CONT saves the display contrast and background settings for the next power-up cycle. MEM:UPD OUTP saves the load type defined by OUTP:MODE (see PAR. B.25). Related commands: SYST:COMM:GPIB:ADDR, SYST:LANG, SYST:SET, VOLT:LIM, CURR:LIM, CURR:PROT:LIM, VOLT:PROT:LIM, OUTP:MODE. See PAR. 3.5.2.2 and Figure 3-17 for special programming considerations.

### B.21 OUTPut[:STATe] COMMAND

## OUTP

Syntax: Short Form: OUTP[:STAT] <boolean> Long Form: OUTPut[:STATe] <boolean>  
<boolean>=(0 or OFF, 1 or ON)

Description: **Enables or disables the power supply output.** The factory default for power-up is Local mode, the output is on and the front panel controls affect the unit's operation; however note that the factory default for power-up can be changed from the front panel (see PAR. 3.3.8). Upon entering Remote mode, the output. status is not affected.

For passive loads, when OUTP OFF is executed, the programmed values of voltage and current are saved, then voltage and current are programmed as follows: when the unit is operating as a voltage source, voltage is programmed to zero and current protect is programmed to a low value; when operating as a current source, current is programmed to zero and voltage protect is programmed to a low value. When OUTP ON is executed, the power supply output is restored to the previously saved programmed values. The saved values of voltage and current can be viewed by VOLT? and CURR? queries.

For active loads (inductive, capacitive, battery or other electronic loads) programming the appropriate settings for mode, voltage and current is recommended instead of using the OUTP OFF command. Follow the guidelines presented in Table 3-6 to understand how the unit responds to OUTP OFF. Instead of using OUTP OFF, program the unit to current mode using the FUNC:MODE command, then program output current to zero. Related Commands: FUNC:MODE, OUTP?.

<p>NOTES: 1. The power supply is assumed to be operating in constant voltage mode.  2. This example creates a 5 Ampere, 100mS current pulse and performs a current measurement during the last five mS of the pulse.</p>	
LIST:CLE	Clear list.
LIST:SET:SAMPLE .0003125	establishes the sample timing. The value was determined by dividing the sample time (0.005S) by the number of samples (16): $(0.005/16 = 0.0003125)$ .
LIST:CURR:APPL LEVEL,.095,5	Creates the initial part of the current pulse. The time duration (0.0950000) establishes where the sample is to begin. It is determined by multiplying the (time per sample) x (number of samples) and subtracting it from the total time of the pulse (100 mS): $[0.1 - (.0003125 \times 16) = .0950000]$
LIST:SAMPLE:CURR 16,5	Creates the sample of the waveform. The output level is 5 amperes and the number of samples is 16.
LIST:SAMPLE?	Returns 60C indicating one sample will be taken after 60 points of a current list (indicated by the C).
LIST:CURR:APPLY LEVEL,.001,0	Creates the end of the current pulse.
LIST:COUNT 1	Sets the number of loops to one. NOTE Count MUST be set to 1 when measuring a sample, otherwise error -100 "command error" will result.
NOTE: The following five commands execute the function:	
FUNC:MODE CURR	Sets unit to constant current mode.
CURR 0	Sets current to 0 Amperes.
VOLT 10	Sets voltage to 10 Volts.
OUTP ON	Sets the output to ON.
CURR:MODE LIST	Causes the list to be executed. Note that the four prior commands ensure that the unit is working in current mode and has its output on before the current pulse is sent.
MEAS:TRAN?	After executing the list, this query returns the measured value of the sample, e.g., 5.0003E0 (5.0003 Amperes).

**FIGURE B-3. USING LIST COMMANDS TO MEASURE SAMPLE AT END OF PULSE**

**B.22 OUTPut[:STATe] QUERY**

**OUTP?**

Syntax: Short Form: OUTP[:STAT]? Long Form: OUTPut[:STATe]?  
Return Value: <int\_value> (0 or 1)

Description: **Indicates whether power supply output is enabled or disabled.** Returns 0 if output disabled, returns 1 if output enabled. Related Commands: OUTP.

- NOTES: 1. The power supply is assumed to be operating in constant voltage mode.  
 2. This example creates a 3 Ampere, 100mS current pulse and performs a current measurement during the first five mS of the pulse.

LIST:CLE	Clear list.
LIST:SET:SAMPLE .0003125	Establishes the sample timing. The value was determined by dividing the sample time (0.005S) by the number of samples (16): (0.005/16 = 0.0003125).
LIST:CURR 0::LIST:DWELL .030	Establishes the list as a current list and sets dwell time for all points at 30 mS.
LIST:SAMPLE:CURR 16,3	Creates the sample of the waveform. The output level is 3 amperes and the number of samples is 16.
LIST:CURR:APPL LEVEL,.095,3	Creates the initial part of the level. It is established by multiplying the time per sample times the number of samples (16) and subtracting it from the total time of the pulse(100 mS): [0.1 - (0.0003125 x (16))] = 0.0950000]
LIST:CURR:APPLY LEVEL,.001,0	Creates the end of the current pulse.
LIST:COUNT 1	Sets the number of loops to one. NOTE: Count MUST be set to 1 when measuring a sample, otherwise error -100 "command error" will result.
	NOTE: The following five commands execute the function:
FUNC:MODE CURR	Sets unit to constant current mode.
CURR 0	Sets current to 0 Amperes.
VOLT 10	Sets voltage to 10 Volts.
OUTP ON	Sets the output to ON.
CURR:MODE LIST	Causes the list to be executed. Note that the four prior commands ensure that the unit is working in current mode and has its output on before the current pulse is sent.
MEAS:TRAN?	After executing the list, this query returns the measured value of the sample. For example, assuming the unit output took 5 mS to become 3 Amperes, the returned value will be around 1.5 Amperes: 1.5003E0 (1.5003 Amperes)

FIGURE B-4. USING LIST COMMANDS TO MEASURE SAMPLE AT START OF PULSE

### B.23 OUTPut:CONTRol COMMAND

## OUTP:CONT

Syntax: Short Form: OUTP:CONT0 {HON | LON | HOFF | LOFF | LPOFF | OFF}  
 Long Form: OUTPut:CONTRol {HON | LON | HOFF | LOFF | LPOFF | OFF}

Description: **Controls the operation of the Remote on/off pin 2 of the Trigger port.** The configuration may be saved for power-up using MEM:UPD INT. Factory default setting is HOFF  
 HON: when pin 2 is logic 1 (high) or open (not connected), output is on (enabled). When logic 0 or short circuit applied to the pin, output is off (disabled) (see NOTE below).  
 LON: when logic 0 (low) or short circuit applied to pin 2, the output is on (enabled), when logic 1 or open (not connected) output is off (disabled) (see NOTE below).  
 HOFF: when pin 2 is logic 1 or open (not connected), output is off (disabled). When logic 0 or short circuit applied to the pin, user can set output on (enabled) via either front panel or by sending OUTP ON command.  
 LOFF: when logic 0 or short circuit applied to pin 2, the output is off (disabled), when logic 1 or open (not connected) user can set output on (enabled) via either front panel or by sending OUTP ON command.  
 LPOFF - Logic 0 or short-circuit for at least 100µS on pin 2 causes the output to go off (disabled). Logic 1 or open does not affect the output; an OUTP ON command must be issued to enable the output.  
 OFF - pin 2 of the Trigger port is disabled and the unit does not respond to signals applied to this pin.

NOTE: HON and LON disable the front panel STANDBY key and prevent OUTP ON and OUTP OFF commands from controlling the output.



## B.24 OUTPut:CONTRol? QUERY

## OUTP:CONT?

Syntax: Short Form: OUTP:CONT? Long Form: OUTPut:CONTRol?  
Return Value: {HON | LON | HOFF | LOFF | LPOFF | OFF}

Description: **Indicates operation of Remote on/off pin 2 of Trigger Port.** Returns HON, LON, HOFF, LOFF or LPOFF, OFF to indicate how Trigger port pin 2 has been configured. (see PAR. B.23 for details).

## B.25 OUTPut:MODE COMMAND

## OUTP:MODE

Syntax: Short Form: OUTP:MODE {ACTIVE | RESIstive | BATTery}  
Long Form: OUTPut:MODE {ACTIVE | RESISTIVE | BATTERY}

Description: **Determines how the unit functions when output is turned off depending on the type of load in use: active, resistive or battery.** See PAR. 3.3.7 for description of ACTIVE, RESISTIVE and BATTERY modes. To save OUTP:MODE state for power-up, send MEM:UPD OUTP (see PAR. B.20).

## B.26 OUTPut:MODE? QUERY

## OUTP:MODE?

Syntax: Short Form: OUTP:MODE? Long Form: OUTPut:MODE]?  
Return Value: ACT | RES | BATT

Description: **Indicates whether power supply is configured for ACTIVE, RESISTIVE or BATTERY type loads.** See PAR. 3.3.7 for description of ACTIVE, RESISTIVE and BATTERY modes. Related Commands: OUTP:MODE.

## B.27 [SOURce:]CURRent[:LEVel][:IMMEDIATE][:AMPLitude] COMMAND

## CURR

Syntax: Short Form: [SOUR:]CURR[:LEV][:IMM][:AMP] <exp\_value>  
Long Form: [SOURce:]CURRent[:LEVel][:IMMEDIATE][:AMPLitude] <exp\_value>  
<exp\_value> = digits with decimal point and Exponent, e.g., 2.71E1 for 27.1

Description: **Sets programmed current level at power supply output.** This command programs output current to a specific value; actual output current will depend on load conditions. Any data that exceeds  $I_{MAX}$  causes error message -222 "data out range" to be posted to the error queue (See example, Figure B-1.)

## B.28 [SOURce:]CURRent[:LEVel][:IMMEDIATE][:AMPLitude] QUERY

## CURR?

Syntax: Short Form: [SOUR:]CURR[:LEV][:IMM][:AMP]? MIN, MAX  
Long Form: [SOURce:]CURRent[:LEVel][:IMMEDIATE][:AMPLitude]? MIN, MAX  
**Return Value:**<exp\_value> = digits with decimal point and Exponent, e.g., 2.71E1 for 27.1

Description: **Returns either the programmed value, maximum value, or minimum value of current.** The CURR? query returns the programmed value of current. Actual output current will depend on load conditions. The CURR?MAX query returns the maximum positive current allowed for a particular model. CURR? MIN returns minimum negative current allowed for power supply (always negative). **Related Commands:** CURR. (See example, Figure B-1.)

## B.29 [SOURce:]CURRent[:LEVel]:LIMit[:BOTH] COMMAND

## CURR:LIM[:BOTH]

Syntax: Short Form: [SOUR:]CURR[:LEV]:LIM[:BOTH] <value>  
Long Form: [SOURce:]CURRent[:LEVel]:LIMit[:BOTH] <value>  
where <value> is between zero and  $I_{NOM}$

Description: Establishes the software limit <value> for output current, i.e., sets the maximum value of output current that the unit will be allowed to source and sink. Requires MEM:UPD (PAR. B.20) to save for power up. See PAR. 3.5.2.2 and Figure 3-17 for special programming considerations. (See Figure B-5)

## B.30 [SOURce:]CURRent[:LEVel]:LIMit[:BOTH]? QUERY

## CURR:LIM[:BOTH]?

Syntax: Short Form: [SOUR:]CURR[:LEV]:LIM[:BOTH]?  
Long Form: [SOURce:]CURRent[:LEVel]:LIMit[:BOTH]?  
Returns <value>, <value>

Description: Identifies the positive software limit, followed by the negative software limit value of output current that the unit can source or sink.

**B.31 [SOURce:]CURRent[:LEVel]:LIMit:NEG COMMAND****CURR:LIM:NEG**

Syntax: Short Form: [SOUR:]CURR[:LEV]:LIM:NEG <value>  
 Long Form: [SOURce:]CURRent[:LEVel]:LIMit:NEGative <value>

Description: Establishes the negative software limit <value> for output current, i.e., sets the maximum value of output current that the unit will be allowed to source (quadrant 3, Figure 1-3) or sink (quadrant 2) to the value specified by the user. Requires MEM:UPD (PAR. B.20) to save for power up. See PAR. 3.5.2.2 and Figure 3-17 for special programming considerations.

**B.32 [SOURce:]CURRent[:LEVel]:LIMit:NEG? QUERY****CURR:LIM:NEG?**

Syntax: Short Form: [SOUR:]CURR[:LEV]:LIM:NEG?  
 Long Form: [SOURce:]CURRent[:LEVel]:LIMit:NEGative?  
 Returns <value>

Description: Identifies the negative software limit value of output current that the unit can source (quadrant 3, Figure 1-3) or sink (quadrant 2).

**B.33 [SOURce:]CURRent[:LEVel]:LIMit:POS COMMAND****CURR:LIM:POS**

Syntax: Short Form: [SOUR:]CURR[:LEV]:LIM:POS <value>  
 Long Form: [SOURce:]CURRent[:LEVel]:LIMit:POSitive <value>  
 where <value> is between zero and the rated (nominal) output voltage

Description: Establishes the positive software limit <value> for output current, i.e., sets the maximum value of output current that the unit will be allowed to source (quadrant 1, Figure 1-3) or sink (quadrant 4) to the value specified by the user. Requires MEM:UPD (PAR. B.20) to save for power up. See PAR. 3.5.2.2 and Figure 3-17 for special programming considerations.

**B.34 [SOURce:]CURRent[:LEVel]:LIMit:POS? QUERY****CURR:LIM:POS?**

Syntax: Short Form: [SOUR:]CURR[:LEV]:LIM:POS?  
 Long Form: [SOURce:]CURRent[:LEVel]:LIMit:Positive?  
 Returns <value>

Description: Identifies the positive software limit value of output current that the unit can source (quadrant 1, Figure 1-3) or sink (quadrant 4).

**B.35 [SOURce:]CURRent:MODE COMMAND****CURR:MODE**

Syntax: Short Form: [SOUR:]CURR:MODE (FIX | LIST | TRAN <nn> | EXT | GAIN | PROT)  
 Long Form: [SOURce:]CURRent:MODE (FIXed | LIST | TRANsient <nn> | EXTernal | GAIN | PROTect)  
 nn = <value> = time in Seconds for transient (from 0.0005 to 2.0)

Description: **Allows the user to execute or stop a list, to execute a transient or to use an external reference in voltage or current mode of operation.** The default mode is FIXed: the power supply executes commands normally, and LIST commands can be issued to establish the parameters and sequence of a list. This command affects the *main channel*, whether voltage or current.

When CURR:MODE LIST is issued, a list is executed (See LIST commands and Figure B-6). While the list is being executed, all output and list change commands except CURR:MODE FIXed and VOLT:MODE:FIXed are not accepted and will produce a command or settings conflict error.

Issuing CURR:MODE FIX while the list is running will stop the execution of the list and return power supply to settings in effect prior to running the list. If the list runs to completion, the settings of the last step of the list will be in effect.

Issuing CURR:MODE HALT while the list is running will stop the execution of the list at the end of the current cycle.

CURR:MODE TRAN nn causes the next CURR: or VOLT: command to produce a transient pulse of nn Seconds duration. (Similar to VOLT:MODE TRAN (see PAR. B.111 for examples). If the time nn exceeds 2 Seconds, error message -222 "dwell or frequency out range" is posted to the error queue.

CURR:MODE EXT Configures the unit to use an external reference to change the main channel, whether voltage or current (see PAR. 3.4). Identical to VOLT:MODE EXT.

CURR:MODE GAIN Configures the unit to use an external reference to provide a proportional output current.

CURR:MODE PROT - allows CURR command to accept values up to the protection limits of the power supply without generating an error. For example for a BOP 36-56MG in current mode, after sending CURR:MODE PROT, sending CURR 56.6 would set the protection levels to 56.6 and main channel level to 56.

**Related Commands:** CURR, LIST commands. (See example, Figure B-6.)

### B.36 [SOURce:]CURRent:MODE? QUERY

## CURR:MODE?

Syntax: Short Form: [SOUR:]CURR[:LEV]:MODE?  
Long Form: [SOURce:]CURRent[:LEVel]:MODE?  
**Return value:** FIXED, LIST, TRANSIENT, EXTERNAL or GAIN

Description: **Identifies active current mode.** Returns LIST while list is being executed. Returns TRANSIENT after CURR:MODE:TRAN command has been issued, but before CURR: or \*TRG command executes the transient. Returns FIXED while in fixed (default) mode of operation. Returns EXT or GAIN when external reference is to be used to either program output current or provide proportional output current, respectively. **Related Commands:** LIST commands. (Similar to VOLT:MODE?, see Figure B-6.)

NOTES: 1. This example assumes a BOP 36-56MG power supply is operating in constant current (CC) mode.  
2. Examples below are intended only to illustrate command functions. Refer to PAR. 3.5.2 for programming techniques to optimize performance.

CURR:LIM?	Returns 56,56 (positive and negative defaults for max current in current mode).
CURR:LIMIT:POS 10;NEG 2	Establishes the maximum positive and negative current values that can be set in current mode.
FUNC:MODE VOLT VOLT 15;CURR 2	Sets power supply in voltage mode. Allows the power supply to provide 15 volts positive with the ability to source or sink up to 2 amperes. The display shows: 15.000 2.000 2.000.
CURR 10	Since the BOP is operating in voltage mode, sets the current capability (current protect) to 10 amperes. The display shows: 15.000 10.000 10.000
CURR:PROT? CURR:PROT:NEG 1 CURR:PROT:LIM:NEG 5	Returns 10,10 Limits the negative current capability to 1 ampere. Prevents CURR:PROT:NEG setting from exceeding 5 amperes
CURR:PROT?	Returns 10,1 (the actual positive (10) and negative (1) protection levels for the current.
---- Turn BOP power off and then on.	
CURR:LIM?	Returns 56,56 the factory default levels (all the above changes have been lost). To lock in the changed limits, the user must send :MEMORY:UPDATE LIMITS.
CURR:PROT:LIM:POS 56.6;NEG 56	Establishes new max current protect limits (positive 56.6 and negative 56.
CURR 56	Establishes the positive protect to be 56 amperes and the negative protection remains 56 amperes.
CURR:PROT?	returns 56,56
FUNC:MODE CURR	Changes the mode of operation of the power supply to current mode.

FIGURE B-5. SETTING LIMITS

### B.37 [SOURce:]CURRent[:LEVel]:PROTect[:BOTH] COMMAND **CURR:PROT[:BOTH]**

Syntax: Short Form: [SOUR:]CURR[:LEV]:PROT:BOTH <value>  
Long Form: [SOURce:]CURRent[:LEVel]:PROTect:BOTH <value>  
where <value> is between minimum (box) value (Figure 1-3) and 1% above rated (nominal) output current.

Description: Establishes both the positive and negative protection limits for current, the maximum current the unit is set up to source and sink; maximum is 1% greater than rated output current.

**B.38 [SOURce:]CURRent[:LEVel]:PROTect[:BOTH] QUERY      CURR:PROT[:BOTH]?**

Syntax:      Short Form: [SOUR:]CURR[:LEV]:PROT[:BOTH]?  
              Long Form: [SOURce:]CURRent[:LEVel]:PROTect[:BOTH]?  
              Returns <value>, <value>

Description: Identifies the protection limits for current (source, sink), the maximum current the unit will source.or sink

**B.39 [SOURce:]CURRent[:LEVel]:PROTect:MODE COMMAND      CURR:PROT:MODE**

Syntax:      Short Form: [SOUR:]CURR[:LEV]:PROT:MODE (EXT | FIX | LESS )  
              Long Form: [SOURce:]CURRent[:LEVel]:PROTect:MODE (EXTernal | FIXed | LESSer )

Description: Determines how current protection limits are controlled in voltage or current mode of operation.  
FIXED - Allows the limits to be controlled by digital signals from either the keypad (if the unit is in local mode) or SCPI command (if the unit is in remote mode).  
EXTERNAL: Allows both current and voltage limits to be controlled by analog signals applied to the analog port; limits set from the keypad or SCPI command have no effect (see PAR. 3.4.5).  
LESSER LIMIT: Allows protect limit to be automatically selected from either 1) the external analog limit CURRENT applied to the Analog I/O port or 2) the value set from the keypad or SCPI command).  
Whichever limit has a lower absolute value (closest to zero) has effect.

**B.40 [SOURce:]CURRent[:LEVel]:PROTect:MODE? QUERY      CURR:PROT:MODE?**

Syntax:      Short Form: [SOUR:]CURR[:LEV]:PROT:MODE?  
              Long Form: [SOURce:]CURRent[:LEVel]:PROTect:MODE?  
              Returns FIXED, EXTERNAL or LESS

Description: Identifies how current protection limits are controlled. (See PAR. B.39 for details).

**B.41 [SOURce:]CURRent[:LEVel]:PROTect:NEGative COMMAND      CURR:PROT:NEG**

Syntax:      Short Form: [SOUR:]CURR[:LEV]:PROT:NEG <value>  
              Long Form: [SOURce:]CURRent[:LEVel]:PROTect:NEGative <value>  
              where <value> is between minimum (box) value (Figure 1-3) and 1% above rated (nominal) output current.

Description: Establishes the negative protection limit for current, maximum is 1% greater than rated (nominal) output current.

**B.42 [SOURce:]CURRent[:LEVel]:PROTect:NEGative? QUERY      CURR:PROT:NEG?**

Syntax:      Short Form: [SOUR:]CURR[:LEV]:PROT:NEG?  
              Long Form: [SOURce:]CURRent[:LEVel]:PROTect:NEGative?  
              Returns <value>

Description: Identifies the negative protection limit for current.

**B.43 [SOURce:]CURRent[:LEVel]:PROTect:POSitive COMMAND      CURR:PROT:POS**

Syntax:      Short Form: [SOUR:]CURR[:LEV]:PROT:POS <value>  
              Long Form: [SOURce:]CURRent[:LEVel]:PROTect:POSitive <value>  
              where <value> is between minimum (box) value (Figure 1-3) and 1% above rated (nominal) output current.

Description: Establishes the positive protection limit for current, maximum is 1% greater than rated output current.

**B.44 [SOURce:]CURRent[:LEVel]:PROTect:POSitive? QUERY      CURR:PROT:POS?**

Syntax:      Short Form: [SOUR:]CURR[:LEV]:PROT:POS?  
              Long Form: [SOURce:]CURRent[:LEVel]:PROTect:POSitive?  
              Returns <value>

Description: Identifies the positive protection limit for current.

**B.45 [SOURCE:]CURRENT[:LEVEL]:PROTECT:LIMIT[:BOTH] COMMAND**  
**CURR:PROT:LIM[:BOTH]**

Syntax: Short Form: [SOUR:]CURR[:LEV]:PROT:LIM[:BOTH] <value>  
Long Form: [SOURCE:]CURRENT[:LEVEL]:PROTECT:LIMIT[:BOTH] <value>  
where <value> is between minimum (box) value (Figure 1-3) and 1% above rated (nominal) output current.

Description: Establishes the maximum value possible for both the positive and negative protection limits for current. Requires MEM:UPD (PAR. B.20) to save for power up. See PAR. 3.5.2.2 and Figure 3-17 for special programming considerations.

**B.46 [SOURCE:]CURRENT[:LEVEL]:PROTECT:LIMIT[:BOTH]? QUERY**  
**CURR:PROT:LIM[:BOTH]?**

Syntax: Short Form: [SOUR:]CURR[:LEV]:PROT:LIM[:BOTH]?  
Long Form: [SOURCE:]CURRENT[:LEVEL]:PROTECT:LIMIT[:BOTH]?  
Returns <exp\_value>,<exp\_value>

Description: Identifies the maximum value possible for protection limits for current (positive, negative); maximum is 1% greater than rated output current.

**B.47 [SOURCE:]CURRENT[:LEVEL]:PROTECT:LIMIT:NEGATIVE COMMAND**  
**CURR:PROT:LIM:NEG**

Syntax: Short Form: [SOUR:]CURR[:LEV]:PROT:LIM:NEG <exp\_value>  
Long Form: [SOURCE:]CURRENT[:LEVEL]:PROTECT:LIMIT:NEGATIVE <exp\_value>  
where <value> is between minimum (box) value (Figure 1-3) and 1% above rated (nominal) output current.

Description: Establishes the minimum (maximum absolute) value possible for the negative protection limit for current. This may be set up to 1% greater than rated current. Requires MEM:UPD (PAR. B.20) to save for power up. See PAR. 3.5.2.2 and Figure 3-17 for special programming considerations.

**B.48 [SOURCE:]CURRENT[:LEVEL]:PROTECT:LIMIT:NEGATIVE? QUERY**  
**CURR:PROT:LIM:NEG?**

Syntax: Short Form: [SOUR:]CURR[:LEV]:PROT:LIM:NEG?  
Long Form: [SOURCE:]CURRENT[:LEVEL]:PROTECT:LIMIT:NEGATIVE?  
Returns: <exp\_value>

Description: Identifies the minimum (maximum absolute) value possible for the negative protection limit for current.

**B.49 [SOURCE:]CURRENT[:LEVEL]:PROTECT:LIMIT:POSITIVE COMMAND**  
**CURR:PROT:LIM:POS**

Syntax: Short Form: [SOUR:]CURR[:LEV]:PROT:LIM:POS <exp\_value>  
Long Form: [SOURCE:]CURRENT[:LEVEL]:PROTECT:LIMIT:POSITIVE <exp\_value>  
where <value> is between minimum (box) value (Figure 1-3) and 1% above rated (nominal) output current.

Description: Establishes the maximum value possible for the positive protection limit for current. This may be set up to 1% greater than rated current. Requires MEM:UPD (PAR. B.20) to save for power up. See PAR. 3.5.2.2 and Figure 3-17 for special programming considerations.

**B.50 [SOURCE:]CURRENT[:LEVEL]:PROTECT:LIMIT:POSITIVE? QUERY**  
**CURR:PROT:LIM:POS?**

Syntax: Short Form: [SOUR:]CURR[:LEV]:PROT:LIM:POS?  
Long Form: [SOURCE:]CURRENT[:LEVEL]:PROTECT:LIMIT:POSITIVE?  
Returns: <exp\_value>

Description: Identifies the maximum value possible for the positive protection limit for current.

## B.51 [SOURce:]CURRent[:LEVel]:TRIGgered[:AMPlitude] COMMAND **CURR:TRIG**

Syntax: Short Form: [SOUR:]CURR[:LEV]:TRIG[:AMP] <exp\_value>  
Long Form: [SOURce:]CURRent[:LEVel]:TRIGgered[:AMPlitude] <exp\_value>  
<exp\_value> = digits with decimal point and Exponent, e.g., 2.71E1 for 27.1

Description: **Programs current value to be transferred to output by \*TRG (trigger) commands.** This command can be used to reset many power supplies to preselected parameters by issuing a single \*TRG command. Actual output current will depend on load conditions. If the value exceeds the maximum for the model being programmed, error message -222, "Data out of range" is posted in output queue. **Related Commands:** CURR, \*TRG, TRIG

## B.52 [SOURce:]CURRent[:LEVel]:TRIGgered[:AMPlitude]? QUERY **CURR:TRIG?**

Syntax: Short Form: [SOUR:]CURR[:LEV]:TRIG[:AMP]?  
Long Form: [SOURce:]CURRent[:LEVel]:TRIGgered[:AMPlitude]?  
**Return Value:** <exp\_value> = digits with decimal point and Exponent, e.g., 2.71E1 for 27.1

Description: **Returns the current value established by CURR:TRIG command.**

## B.53 [SOURce:]FUNCtion:MODE COMMAND **FUNC:MODE**

Syntax: Short Form: FUNC:MODE {VOLT | CURR | EXT}  
Long Form: [SOURce:]FUNCtion:MODE {VOLT | CURR | EXTernal}

Description: **Establishes the operating mode of the power supply.** VOLT = Constant Voltage mode (CV). CURR = Constant Current mode (CC). EXT = External. FUNC:MODE VOLT commands power supply to Voltage mode, FUNC:MODE CURR commands power supply to Current mode. Commanded mode establishes parameters (voltage or current) monitored for error conditions. Actual mode depends upon load conditions. When commanded to Voltage mode, if load conditions cause the power supply to try to exceed the current limit, the unit will flag an error condition. When commanded to Current mode, if load conditions cause the power supply to try to exceed the voltage limit, the unit will flag an error condition.

## B.54 [SOURce:]FUNCtion:MODE? QUERY **FUNC:MODE?**

Syntax: Short Form: FUNC:MODE? Long Form: [SOURce:]FUNCtion:MODE?  
**Return value:** 0 (voltage mode) or 1 (current mode)

Description: **Returns the operating mode of the power supply.** 0 = Constant Voltage mode (CV). 1 = Constant Current mode (CC).

## B.55 [SOURce:]FUNCtion:MODE:TRIGger COMMAND **FUNC:MODE:TRIG**

Syntax: Short Form: FUNC:MODE:TRIG {VOLT | CURR}  
Long Form: [SOURce:]FUNCtion:MODE:TRIGger {VOLT | CURR}

Description: **Establishes the operating mode of the power supply when a TRIGger command is sent.** VOLT = Constant Voltage mode (CV). CURR = Constant Current mode (CC). FUNC:MODE:TRIG VOLT commands power supply to Voltage mode when a TRIGger command is sent, FUNC:MODE:TRIG CURR commands power supply to Current mode when a TRIGger command is sent.

## B.56 [SOURce:]FUNCtion:MODE:TRIGger? QUERY **FUNC:MODE:TRIG?**

Syntax: Short Form: FUNC:MODE:TRIG? Long Form: [SOURce:]FUNCtion:MODE:TRIGger?  
**Return value:** 0 = voltage mode or 1 = current mode

Description: **Returns the operating mode which the power supply will enter when a trigger command is sent.** VOLT = Constant Voltage mode (CV). CURR = Constant Current mode (CC).

## B.57 [SOURce:]LIST:CLEar COMMAND **LIST:CLE**

Syntax: Short Form: LIST:CLE Long Form: LIST:CLEar>

Description: **Clears all list entries by setting all pointers to 0 and sets LIST:SEG to REP.** Releases control of the Output Off flag at EXT PROTECT PORT, pins 5 and 6 (see Table 2-6), from the programmed list. **Related Commands:** All LIST commands (See example, Figure B-6.)

## LIST:COPY

### B.58 [SOURCE:]LIST:COPY COMMAND

Syntax: Short Form: LIST:COPY <x>, <y> Long Form: LIST:ERASe <x>, <y>  
Where <x> = location of waveform to be copied (1 to 16).  
<y> = empty location where waveform is to be copied (1 to 16).

Description: **Used to copy waveform location specified by <x> to empty waveform location specified by <y>.**

### B.59 [SOURCE:]LIST:COUNt COMMAND

## LIST:COUN

Syntax: Short Form: LIST:COUN<int\_value 0 to 255> Long Form: LIST:COUNt<int\_value 0 to 255>

Description: **Establishes how many times the list is executed.** Allows user to establish how many times the list is executed. For LIST:COUN 0, the unit will execute the sequence indefinitely until a VOLT:MODE FIXED, command is received. (See example, Figure B-6.)

NOTES: Examples below are intended only to illustrate command functions. Refer to PAR. 3.5.2 for programming techniques to optimize performance.

LIST:CLEAR	Initializes the list process.
LIST:RES?	Returns 0.000093,0.034000,nnnn (where nnnn = total number of points available).
LIST:VOLT:POINTS?	Returns 0.
LIST:VOLT:POINTS? MAX	Returns 5900.
LIST:VOLT:APPLY SINE,15,10	Causes the BOP to generate points for 15Hz sine wave, 10V p-p.
LIST:VOLT:POIN?	Returns 480 - indicating the unit used 480 points for the sine wave.
LIST:VOLT:POIN? MAX	Returns 3933 - indicating up to 3933 points can be used.
LIST:DWEL:POIN?	Returns 480 - indicating 480 points have been assigned dwell times.
LIST:DWEL?	Returns 1.38e-4 indicating the unit used 138 $\mu$ S per division (automatically selected as the best possible dwell for the waveform).
FUNC:MODE VOLT	Initializes the power supply mode to be voltage.
LIST:CLEAR	Initializes the list processor to add entries, clears main channel (LIST:CURREN or LIST:VOLT) and LIST:DWEL data tables (Table B-3).
LIST:VOLT -20,-18,-16,-14,-12,-10,-8,-6,-4,-2,0	Starting at location 0 (-20), up to location 10 (0), fills the list with 11 data points.
LIST:VOLT:POIN?	Returns 11. Indicates that 11 data points have been entered, and location 11 is the next location to be filled (for the 12th data point).

NOTE: See PAR. B.2 for format and accuracy of all numerical data returned.

LIST:QUERY?	Returns 0 (pointer cleared by LIST:CLE).
LIST:VOLT?	Returns -20,-18,-16,-14,-12,-10,-8,-6,-4,-2,0 (the contents of locations 0 through 10). (See PAR. B.2 for format and accuracy of numerical data.)
LIST:VOLT 2,4,6,8,10,12,14,16,18,20	Adds 10 points to the list (location 11 through 20). List now has 21 points.
LIST:VOLT:POIN?	Returns 21 (the next location to be filled by LIST:VOLT).
LIST:COUNT 100	Specifies that when VOLT:MODE LIST is issued, the user-determined sequence will be executed 100 times. (21 steps in the list will be executed 100 times)
CURR 1;VOLT -20	initializes the BOP output
OUTPUT ON	Turns the output on (BOP now provides -20 volts)
LIST:DWELL .010	Sets the time duration for location 0 to be 0.010 Second (Since dwell times for the rest of the locations in the list are not entered before running the list, the dwell time will be 0.010 Second for all locations).

FIGURE B-6. USING LIST COMMANDS AND QUERIES (SHEET 1 OF 2)

VOLT:MODE LIST	Executes the list. For 240 mS the BOP outputs a staircase triangle wave from -20V to +20V and back down to -20V. This staircase will have a uniform spacing between voltage changes of 10 mS and will repeat 100 times.
VOLT?	Returns +20 (the last step in the list set the unit to +20V).
LIST:COUNT?	Returns 100.
LIST:COUNT 10	Determines that the list will be repeated 10 times when executed.
LIST:COUNT?	Returns 10.
VOLT:MODE LIST	Initiates execution of the list. The unit outputs a sawtooth waveform that increases from -20V to +20V and repeats 10 times. There is an abrupt change from +20V to -20V each time the list transitions from location 20 to location 0.
VOLT?	Returns 20, (the last step in the list set the unit to 20V).
LIST:DWELL .01,.01,.01,.01,.01,.01,.01,.01,.01	Enters dwell time of 0.01 Seconds in locations 1 through 9.
LIST:DWELL .03	Enters dwell time of 0.03 Second in location 10.
VOLT:MODE LIST	the list is not executed, the unit returns error -221,Settings Error indicating the lists are not balanced.
LIST:DWELL:POINTS?	Returns 11 to indicate the dwell list has 11 entries
LIST:VOLT:POINTS?	Returns 21 to indicate the voltage list has 21 entries.
LIST:DWELL .01,.01,.01,.01,.01,.01,.01,.01,.01	Dwell times are entered in locations 11 through 20.
DWELL:POINTS?	Returns 21 indicating there are now 21 step dwell times on the list.
LIST:QUER?	Returns 0 indicating list queries will start from location 0
LIST:QUER 9	Causes list queries to start at location 9
LIST:DWEL?	Returns 01,.03,.01,.01,.01,.01,.01,.01,.01,.01,.01,.01(the dwell times for locations 9 through 20.
LIST COUNT 0	List will repeat indefinitely.
VOLT:MODE LIST	The list is executed. Stair case wave now consists of 21 steps of 0.01 Seconds except for the 0V step (location 10) which outputs 0V for 0.03 Second.
LIST:DWEL?	Returns error -221,Settings Error because a LIST command cannot be executed while the LIST is still being executed.
VOLT:MODE FIX	Stops execution of the list
LIST:VOLT:APPLY SINE,60,20	Adds a 60Hz, 20V p-p sine wave to the current waveform
VOLT:MODE:LIST	Unit outputs the staircase and then the sine wave.
*RST	Unit stops generating the waveform.

FIGURE B-6. USING LIST COMMANDS AND QUERIES (SHEET 2 OF 2)

**B.60 [SOURCE:]LIST:COUNT? QUERY**

**LIST:COUN?**

Syntax: Short Form: LIST:COUNT? Long Form: LIST:COUNT?  
Return Value: <int\_value>

Description: **Identifies how many times the list will be executed.** Returns value set by LIST:COUN command. (See example, Figure B-6.)

**B.61 [SOURCE:]LIST:COUNT:SKIP COMMAND**

**LIST:COUN:SKIP**

Syntax: Short Form: LIST:COUN:SKIP nn Long Form: LIST:COUNT:SKIP nn  
nn = <int\_value 0 to 255>

Description: **Allows beginning steps of list-generated waveform to be run once, then ignored.**

When a list is to be repeated using LIST:COUNT, this command allows the user to skip the first nn steps once the full set has been executed. After the first iteration (which executes all steps), the first nn steps are skipped. The LIST:COUN:SKIP command allows the user to precondition a list-generated waveform by setting unique conditions at the beginning that are not repeated for the rest of the repetitions. LIST:CLEAR sets nn to 0. Related Commands: LIST:COUN, LIST:COUN:SKIP?, LIST:CLEAR. (See example, Figure B-6.)



**B.62 [SOURCE:]LIST:COUN:SKIP? QUERY****LIST:COUN:SKIP?**

Syntax: Short Form: LIST:COUN:SKIP? Long Form: LIST:COUN:SKIP?  
 Return Value: <int\_value>

Description: **Identifies how many steps will be skipped the first time the list is executed.** Returns value set by LIST:COUN:SKIP command. (See example, Figure B-6.)

NOTE: The example below assumes that unit is in voltage mode (FUNC:MODE VOLT) and output is on (OUTP ON). Figure 3-14 shows the sample waveform produced by the following commands.

LIST:CLE	Clears the LIST and sets LIST:SEG to repeat.
LIST:SEGM INIT	Sets the next segment as initial
LIST:VOLT:APPL LEV,0,.001,5	sets the first (non-repeating) segment to a level of 1.5V for a duration of 0.001 seconds.
LIST:VOLT:APPL LEV,0.002,0	Sets segment 2 (non-repeating) to 0V for a duration of 0.002 seconds.
LIST:VOLT:APPL:SWE 0,90	Sets segment 3 (non-repeating) to start at 0° and end at 90°.
LIST:VOLT:APPL SINE, 25,20	Sets segment 3 as a 25 Hz sinewave, 20V p-p. Due to previous command voltage goes from 0V at 0° to 10V at 90°.
LIST:VOLT:APPL:SWE 0,360	Sets segment 4 (non-repeating) to start a 0° and end at 360°.
LIST:VOLT:APPL RAMP-,50,4,8	Sets segment 3 as a decreasing 50Hz ramp, 20V p-p, at 8V offset. Due to previous command voltage goes from 10V at 0° to 6V at 360°.
LIST:SEGM REP	Sets the next segment as repeating
LIST:VOLT:APPL:SWE 0,90	Sets segment 4 (repeating) to start a 0 degrees and end at 90 degrees.
LIST:VOLT:APPL SINE, 50,8,6	Sets segment 4 as a 50 Hz sinewave, 8V p-p. at 6V offset. Voltage starts at 6V at 0°, then rises as sine to 10V at 90° due to previous command.
LIST:VOLT:APPL:SWE 0	Sets segment 5 start point at 0° and end point (implied) at 360°.
LIST:VOLT:APPL RAMP-,50,4,8	Sets segment 5 as a decreasing 50Hz ramp, 20V p-p, at 8V offset
CURR:PROT: 10	Sets Current protection to 10 Amps.
LIST:COUN 0	Set Count to 0, causing the repeating segments to repeat forever.
LIST:SAVE CAPCHARGE,1	Saves segments as CAPCHARGE in location 1.
	Once waveform has been constructed and saved, it can be executed.
VOLT:MODE:LIST	Executes the saved waveform
VOLT:MODE:HALT	Stops the waveform, leaving the output at 6V
	After unit is powered off, the waveform can be recalled when unit is powered on.
LIST:DIR? 1	Returns 1 VOLT CAPCHARGE indicating that a waveform to be run in voltage mode entitled CAPCHARGE is stored in location 1.
LIST:CLE	Good practice to always clear the list prior to recalling a waveform.
LIST:REC 1	Loads the waveform stored in location 1 into memory.
MEM:LIST? 4	Returns SINE,REP,50,8.00001,6.0000,0.0,90. This is the 4th segment of the waveform stored in memory and can be verified against the previously saved CAPCHARGE waveform. Note that due to rounding errors the values returned may not exactly match the values programmed (e.g. 8.00001).
CURR:PROT 10	Sets current protection to 10A. The command must be issued when using remote commands to execute a waveform because it is only recalled automatically when executing a waveform from the front panel.
FUNC:MODE VOLT	Unit must be set to voltage mode to run a voltage waveform.
OUTP ON	Waveform can only be executed when output is on.
VOLT:MODE LIST	Executes the waveform.

**FIGURE B-7. CREATING AND EXECUTING A COMPLEX WAVEFORM USING LIST COMMANDS**

**B.63 [SOURCE:]LIST:CURRENT COMMAND**

**LIST:CURR**

Syntax: Short Form: LIST:CURR <exp\_value>, <exp\_value>, . . . (to max of 5900 data points for global dwell time)  
 Long Form: LIST:CURRENT <exp\_value>, <exp\_value>, . . . (to max of 5900 data points for global dwell time)  
 <exp\_value> = digits with decimal point and Exponent, e.g., 2.71E1 for 27.1

Description: **Adds the current value (in Amps) to list.** This command sequentially adds LIST:CURRENT values to the main channel List Data Table locations illustrated in Table B-3. Starting location is indicated by LIST:CURR:POIN? The maximum number of entries is 2950,3933 or 5900. Since the input buffer of the BOP has a limit of 253 characters, multiple commands are necessary to complete the full 3933 entries of the list. If LIST:VOLT has any entries, an error message: -221,"Settings conflict" is posted in the error queue. Related Commands: LIST:CURR:POIN?. (See example, Figure B-6.).

**TABLE B-3. LIST DATA TABLE**

Location (DSEQ)	0	1	2	3	4	5	6	7	8	9	10	11	12	13	14	15	16	17	.....	5900
Main Channel (commanded mode) LIST:CURRENT or LIST:VOLTage																			.....	
LIST:DWELI																			.....	

**B.64 [SOURCE:]LIST:CURRENT? QUERY**

**LIST:CURR?**

Syntax: Short Form: LIST:CURR? Long Form: LIST:CURRENT?  
 Return Value: <value1>, <value2>, . . . to <value16>

Description: **Identifies the parameters (main channel) entered for the list.** Starting at location established by LIST:QUERY, returns comma-separated list of up to 16 values indicating the main channel parameters entered. i.e., the contents of main channel locations of Table B-3. Related Commands: LIST: CURR, LIST:QUERY. If LIST:VOLT has any entries, an error message: -221,"Settings conflict" is posted in the error queue. (See example, Figure B-6.)

**B.65 [SOURCE:]LIST:CURR:APPLY COMMAND**

**LIST:CURR:APPL**

Syntax: Short Form: LIST:CURR:APPL <type>,<value1>,<value2>[,<value3>]  
 Long Form: LIST:CURRENT:APPLY <type>,<value1>,<value2>[,<value3>]  
 Where <type> is {SQUARE | RAMP+ | RAMP- | TRIangle | SINE | LEVel | SLOPe | ZINCrement | ZDECrement}  
 <value1> is frequency in Hz, except for the following:  
 LEVel: period (duration) in seconds  
 SLOPe: period (duration) in seconds  
 ZINCrement or ZDECrement: number of steps  
 <value2> is p-p amplitude in Amperes, except for the following:  
 LEVel: amplitude (offset) in Amperes  
 SLOPe: starting amplitude in Amperes  
 ZINCrement: not supported  
 ZDECrement: not supported  
 <value3>is offset (optional, default is 0, not applicable to LEVel, ZINCrement, ZDECrement or End point for SLOPe type segments.  
 NOTES:1. <value2> is optional for all <types> except SLOPe, ZINC and ZDEC.  
 2. ZDINC and ZDEC are allowed only in the first segment, but are allowed in the second segment if ZINC and ZDEC are also present in the first segment.

Description: **Causes the unit to add a series of points to both the list:curr array and the list:dwell array to make either a level or a waveform segment of one of six types.** Refer to table 3-12 for a description of the waveform types and frequency limits. Maximum number of segments in a waveform is 100.  
 Except as noted below, the waveform type specified is generated at the frequency specified with a peak-to-peak amplitude centered on zero.  
 If the optional offset value is specified, the center of the generated series of points is moved off zero to the offset amplitude specified. This applies to offset of sine, triangle,  $\pm$ ramp, and square waveforms and to Level waveform amplitude.  
 For LEVel, sets the output to amplitude of <value2> which remains for the entire segment time specified by <value1>.

For SLOPe the segment begins with the start point <value2>. If <value2> not provided, segment begins with the previous segments last level or 0 if there was no prior segment. The segment ends at time specified by <value 1> at the end level specified by <value3>. Slope is like RAMP+ and RAMP- with the ramp specified as start and end points and time versus amplitude and offset and frequency.

ZDECrement and ZINCrement allow for the segments that follow to be repeated for a number of steps with varying amplitude. <value 1> is the number of steps, from 3 (minimum) to 50 (maximum), specifying the number of times the repeating waveform segments are repeated. ZDEC or ZINC must be the first segment(s) in a waveform. If ZDEC or ZINC is the first segment, then another ZINC or ZDEC is allowed in the second segment.

See Figures B-12 and B-13 for an example using ZDEC and ZINC with LIST:VOLT:APPL which is very similar to LIST:CURR:APPL.

## **B.66 [SOURCE:]LIST:CURRENT:APPLY:SWEep COMMAND LIST:CURR:APPL:SWE**

Syntax: Short Form: LIST:CURR:APPL:SWE <value1>,<value2>  
Long Form: LIST:CURRENT:APPLY:SWEep <value1>,<value2>  
Where <value1> is start angle. Valid from 0 to 359.99 degrees.  
<value2> is stop angle. Valid from 0.01 to 360.00 degrees

Description: **Allows the user to provide a starting angle for either triangle and sine waveforms and an optional stop angle.** If the stop angle is not supplied, the unit defaults to 360 degrees. This command should be placed at the beginning of the waveform program to be applicable to all sine and triangle waveform segments.

## **B.67 [SOURCE:]LIST:CURRENT:APPLY:SWEep? QUERY LIST:CURR:APPL:SWE?**

Syntax: Short Form: LIST:CURR:APPL:SWE? Long Form: LIST:CURRENT:APPLY:SWEep?  
Return Value: <value1>, <value2>(0.01 to 360)

Description: **Returns start <value1> and stop <value2> angle in degrees for either triangle and sine waveforms.**

## **B.68 [SOURCE:]LIST:CURRENT:POINTS? QUERY LIST:CURR:POIN?**

Syntax: Short Form: LIST:CURR:POIN? Long Form: LIST:CURRENT:POINTS?  
Return Value: <n> where n = number of points

Description: **Identifies the total number of points present in a list and the next location to be filled by LIST:CURR command.** The LIST:CURR pointer is initially at 0 via LIST:CLE. For each data point entered by a LIST:CURR command the list pointer is incremented. If LIST:CURR:POIN? returns 5, the LIST:CURR pointer is at 5 indicating there are 6 data points comprising the list. If LIST:VOLT has any entries, an error message: -221,"Settings conflict" is posted in the error queue. Related Commands: LIST:CURR. (See example, Figure B-6.)

## **B.69 [SOURCE:]LIST:DIRECTORY? QUERY LIST:DIR?**

Syntax: Short Form: LIST:DIR? <n> Long Form: LIST:DIR? <n>  
where <n> = number used to specify one of 16 locations used to store waveforms

Description: **Reads the contents of the locations used to store waveforms from either front panel or using LIST:SAVE command.** LIST:DIR? returns comma-separated string representing titles of waveforms stored in each of 16 locations. Locations that have not had a waveform saved, or were erased using LIST:ERASE show up as "Empty." As an example, if there was one waveform stored in location 2, titled TEST, and the other 15 locations were empty, the string returned would be:  
1 Empty,2 TEST,3 Empty,4 Empty,5 Empty,6 Empty,7 Empty,8 Empty,9 Empty,10 Empty,11 Empty,12 Empty,13 Empty,14 Empty,15 Empty,16 Empty

Sending LIST:DIR? 2 would return 2 TEST for the above example.

## **B.70 [SOURCE:]LIST:DIVider COMMAND LIST:DIV**

Syntax: Short Form: LIST:DIV <value> Long Form: LIST:DIVider <value>  
Where <value> is an integer between 1 and 255

Description: **Provides ultralow frequency for waveforms below 0.1Hz.** The value entered (from 1 to 255) divides the frequency of waveforms (see PAR. B.66 for Current waveforms, PAR. B.96 for voltage waveforms.) This command is only effective for sine,  $\pm$ ramp and triangle waveforms with frequency

set below 0.1Hz and square waveforms with frequency set below 0.2Hz, and has no effect on levels. E.g., with waveform frequency 0.01Hz, sending LIST:DIV 5 changes the waveform frequency to 0.002Hz (0.01/5=0.002). Using this command, waveform frequencies as low as 0.0000392Hz can be attained (0.01/255). Sending list:volt:apply sine,.001,10 command automatically sets LIST:DIV to 10. Sending LIST:CLear resets LIST:DIV to 1 (except for sine waveforms with a frequency below 0.01Hz, in which case LIST:DIV will remain at 10, which is used to obtain sine frequencies below 0.01Hz.

### B.71 [SOURCE:]LIST:DIVider? QUERY

### LIST:DIV?

Syntax: Short Form: LIST:DIV? Long Form: LIST:DIVider?  
Return Value: <n> where n = number between 1 and 255

Description: **Identifies the divider to be used in attaining waveform frequencies below 0.01Hz (0.02Hz for square waves) (see PAR. B.70).**

### B.72 [SOURCE:]LIST:DWELI COMMAND

### LIST:DWEL

Syntax: Short Form: LIST:DWEL <value> (0.000093 to 0.034),<value>,<value>, . . . to maximum of 5900 values.

Long Form: LIST:DWELI <value> (0.000093 to 0.034),<value>,<value>, . . . to maximum of 5900 values.

Description: **Determines how long the main channel parameters will be active.** Sets time value (from 0.000093 to 0.034) in Seconds for List:Dwell locations illustrated in Table B-3. These locations are associated with the corresponding main channel locations illustrated in Table B-3. The main channel is determined by FUNC:MODE, either current (FUNC:MODE CURR) or voltage (FUNC:MODE VOLT) If LIST:DWEL is entered for only location 0, that time duration will apply to all steps when either VOLT:MODE LIST or CURR:MODE LIST is executed. Related Commands: VOLT:MODE, FUNC:MODE, LIST:CURR, LIST:VOLT, LIST:DWEL?. (See example, Figure B-6.)

### B.73 [SOURCE:]LIST:DWELI? QUERY

### LIST:DWEL?

Syntax: Short Form: LIST:DWEL? Long Form: LIST:DWELI?  
Return Value: <value>

Description: **Identifies the dwell times entered for the list.** Starting at location established by LIST:QUERY, returns comma-separated list of up to 16 values indicating the dwell time parameters entered. i.e., the contents of LIST:DWEL locations of Table B-3. Related Commands: LIST: DWEL, LIST:QUERY. (See example, Figure B-6.)

### B.74 [SOURCE:]LIST:DWELI:POINts? QUERY

### LIST:DWEL:POIN?

Syntax: Short Form: LIST:DWEL:POIN? Long Form: LIST:DWELI:POINts?  
Return Value: <value> (0 to 5900)

Description: **Identifies the number of locations for which time values have been entered and the next location to be filled by a LIST:DWEL command.** If LIST:DWEL:POIN? returns 6, dwell times have been entered for locations 0 through 5 and location 6 is the next to be filled by a LIST:DWEL command. LIST:DWEL, LIST:DWEL:POIN. (See example, Figure B-6.)

### B.75 [SOURCE:]LIST:ERASe COMMAND

### LIST:ERAS

Syntax: Short Form: LIST:ERAS <int\_value> Long Form: LIST:ERASe <int\_value>  
int\_value = <n> where n = waveform location (from 1 to 16) to be erased

Description: **Used to erase one of 16 stored waveforms.**

### B.76 [SOURCE:]LIST:QUERy COMMAND

### LIST:QUER

Syntax: Short Form: LIST:QUER <int\_value>  
Long Form: LIST:QUERy <int\_value>  
int\_value = <n> where n = first location to be queried.

Description: **Determines first location to be queried by LIST:VOLT?, LIST:CURR? or LIST:DWEL? queries.** Related Commands: LIST:VOLT?, LIST:CURR?, LIST:DWEL?. LIST:QUER?. (See example, Figure B-6.)

### B.77 [SOURCE:]LIST:QUERy? QUERY

### LIST:QUER?

Syntax: Short Form: LIST:QUER? Long Form: LIST:QUERy?  
Return Value: <int\_value>

Description: **Identifies first location to be queried by LIST:VOLT?, LIST:CURREN?, LIST:DWELL? queries.**  
Related Commands: LIST:QUER, LIST:CURREN?, LIST:DWELL?. LIST:QUER?. (See example, Figure B-6.)

#### B.78 [SOURCE:]LIST:RECALL COMMAND

### LIST:REC

Syntax: Short Form: LIST:REC <n> Long Form: LIST:RECALL <n>  
where:  
<n> = number from 1 to 16 representing location where waveforms are stored.

Description: **Recalls the waveform previously saved in location specified by <n>.** This command must be preceded by LIST:CLE, otherwise a "lists not same length" error is generated. If the location specified is empty, a "name not found" error is generated.

#### B.79 [SOURCE:]LIST:REPEAT COMMAND

### LIST:REP

Syntax: Short Form: LIST:REP <int\_value1>,<int\_value2>,<array>  
Long Form: LIST:REPEAT <int\_value1>,<int\_value2>,<array>  
where <int\_value1> is start point to be copied  
<int\_value2> is end point to be copied  
<array> is a series of comma separated values representing the new programmed current (Amps) for current list, or programmed voltage (Volts) for voltage list.

Description: **Copies points from existing list using the same dwell times, but different output settings.** Copies the contents of the dwell entries in the list from the start point to the end point and adds them to the end of the list. The setting value for each copied point is defined by the value in the array. This process is repeated until either a) an invalid programmed current or voltage is found, b) the all entries in the array have been copied or c) the list is full.

This command must be preceded by LIST:CURREN or LIST:VOLT command and the starting and end point values must be valid, otherwise a -221 "Settings conflict" error results. The entries on the dwell list must match the values in the current or voltage list, otherwise a -226 "Not Same Length" error results. (See Figures B-10 and B-11.)

#### B.80 [SOURCE:]LIST:RESOLUTION? QUERY

### LIST:RES?

Syntax: Short Form: LIST:RES? Long Form: LIST:RESOLUTION?  
Return Value: <value1>,<value2>,<value3>  
(where <value1> and <value2> = clock period, <value3> = number of points to be used)

Description: **Identifies whether resolution is set to minimum (3933) or maximum (5900) and indicates the clock period.** The resolution (3933 or 5900) determines the maximum number of points that will be used for the waveform. <value1> and <value2> indicate the boundaries of acceptable dwell times: e.g., if LIST:RES? returns either 0.000093,0.034000,3933 or 0.034000,0.000093,5900 dwell times faster than 93  $\mu$ S and slower than 34 mS will not be accepted.

#### B.81 [SOURCE:]LIST:SAMPLE:CURRENT COMMAND

### LIST:SAMP:CURREN

Syntax: Short Form: LIST:SAMP:CURREN average,value  
Long Form: LIST:SAMPLE:CURREN average,value  
where:  
<average> = number of measurements = integer: 2, 4, 8, 16, 32, 64, 128 or 256  
<value> = programmed current (Amps) for current list, or programmed voltage (Volts) for voltage list.

Description: **Samples output current.** <Value> is either programmed current in Amperes, or programmed voltage in Volts. <Average> can only be 2, 4, 8, 16, 32, 64, 128 or 256. Entering a number other than those permitted results in the average being set to the next lowest permitted number. The actual number of points added to the list is <average>. The samples are taken within the window established by <aver-

age>. The timing of the first sample is not exact. The sample duration must be established by the LIST:SET:SAMP command, otherwise a -221 "Settings conflict" error will result

This command must be preceded by LIST:CURR, LIST:VOLT or LIST:SET:SAMPLE command, otherwise a -221 "Settings conflict" error will result. The entries on the dwell list must match the values on the current or voltage list, otherwise a -226 "Not Same Length" error will result. Only eight samples may be taken in a list. If more than eight LIST:SAMP:CURR or LIST:SAMP:VOLT commands are included in the list, a -223 "Too Much data" error results. Also, note that each sample uses one of the points in the waveform table; if the total number of points in the waveform exceeds 3933, -223 "Too Much data" error results. (See Figures B-10 and B-11.)

## B.82 [SOURce:]LIST:SAMPle:VOLTage COMMAND

## LIST:SAMP:VOLT

Syntax: Short Form: LIST:SAMP:VOLT average,value  
Long Form: LIST:SAMPle:VOLTage average,value  
where:

average = number of measurements = integer: 2,4,8,16,32,64,128 or 256

value = programmed current (Amps) for current list, or programmed voltage (Volts) for voltage list.

Description: **Samples output voltage.** <Value> is either programmed current in Amperes, or programmed voltage in Volts. <Average> can only be 2, 4, 8, 16, 32, 64, 128 or 256. Entering a number other than those permitted results in the average being set to the next lowest permitted number. The actual number of points added to the list is <average>. The samples are taken within the window established by <average>. The timing of the first sample is not exact. The sample duration must be established by the LIST:SET:SAMP command, otherwise a -221 "Settings conflict" error will result

This command must be preceded by LIST:CURR, LIST:VOLT or LIST:SET:SAMPLE command, otherwise a -221 "Settings conflict" error will result. The entries on the dwell list must match the values on the current or voltage list, otherwise a -226 "Not Same Length" error will result. Only eight samples may be taken in a list. If more than eight LIST:SAMP:CURR or LIST:SAMP:VOLT commands are included in the list, a -223 "Too Much data" error results. Also, note that each sample uses one of the points in the waveform table; if the total number of points in the waveform exceeds 3933, -223 "Too Much data" error results. (See Figures B-8 and B-9.)

- NOTES: 1. The power supply is assumed to be operating in constant voltage mode.  
 2. This example creates a 5-Ampere, 100-millisecond current pulse and performs a current measurement during the last five milliseconds of the pulse.

list:cle	Clear list.
list:set:sample .0003125	establishes the sample timing. The value was determined by dividing the sample time (0.005S) by the number of samples (16): $(0.005/16 = 0.0003125)$ .
list:curr:appl level,.095,5	Creates the initial part of the current pulse. The time duration (0.0950000) establishes where the sample is to begin. It is determined by multiplying the (time per sample) x (number of samples) and subtracting it from the total time of the pulse (100 milliseconds): $[0.1 - (.0003125 \times 16) = .0950000]$
list:sample:curr 16,5	Creates the sample of the waveform. The output level is 5 amperes and the number of samples is 16.
list:sample?	Returns 60C indicating one sample will be taken after 60 points of a current list (indicated by the C).
list:curr:apply level,.001,0	Creates the end of the current pulse.
list:count 1	Sets the number of loops to one. NOTE Count MUST be set to 1 when measuring a sample, otherwise error -100 "command error" will result.
NOTE: The following five commands execute the function:	
func:mode curr	Sets unit to constant current mode.
curr 0	Sets current to 0 Amperes.
volt 10	Sets voltage to 10 Volts.
outp on	Sets the output to ON.
curr:mode list	Causes the list to be executed. Note that the four prior commands ensure that the unit is working in current mode and has its output on before the current pulse is sent.
Meas:tran?	After executing the list, this query returns the measured value of the sample, e.g., 5.0003E0 (5.0003 Amperes).

**FIGURE B-8. USING LIST COMMANDS TO MEASURE SAMPLE AT END OF PULSE**

- NOTES: 1. The power supply is assumed to be operating in constant voltage mode.  
 2. This example creates a 3-Ampere, 100-millisecond current pulse and performs a current measurement during the first five milliseconds of the pulse.

list:cle	Clear list.
list:set:sample .0003125	Establishes the sample timing. The value was determined by dividing the sample time (0.005S) by the number of samples (16): $(0.005/16 = 0.0003125)$ .
list:curr 0;;list:dwel .030	Establishes the list as a current list and sets dwell time for all points at 30 milliseconds.
list:sample:curr 16,3	Creates the sample of the waveform. The output level is 3 amperes and the number of samples is 16.
list:CURR:appl level,.095,3	Creates the initial part of the level. It is established by multiplying the time per sample times the number of samples (16) and subtracting it from the total time of the pulse(100 milliseconds): $[0.1 - (.0003125 \times (16)) = .0950000]$
list:curr:apply level,.001,0	Creates the end of the current pulse.
list:count 1	Sets the number of loops to one. NOTE: Count MUST be set to 1 when measuring a sample, otherwise error -100 "command error" will result.
	NOTE: The following five commands execute the function:
func:mode curr	Sets unit to constant current mode.
curr 0	Sets current to 0 Amperes.
volt 10	Sets voltage to 10 Volts.
outp on	Sets the output to ON.
curr:mode list	Causes the list to be executed. Note that the four prior commands ensure that the unit is working in current mode and has its output on before the current pulse is sent.
Meas:tran?	After executing the list, this query returns the measured value of the sample. For example, assuming the unit output took 5 milliseconds to become 3 amperes, the returned value will be around 1.5 amperes: 1.5003E0 (1.5003 Amperes)

**FIGURE B-9. USING LIST COMMANDS TO MEASURE SAMPLE AT START OF PULSE**



<p>NOTES: 1. The power supply is assumed to be operating in constant voltage mode.</p> <p>2. The WAIT commands provide a method to synchronize multiple instruments to a common control pulse. This example assumes BOP and a number of switching DVMs are connected to a Unit Under Test (UUT). The DVMs are programmed to wait 1 mS after a high pulse is received from the host computer, then take a few measurements. The same high pulse is applied to the Trigger Input (pin 3 of the BOP Trigger Port); the negative-going edge of this pulse will cause the BOP to increment the output to the next level. Thus, each time the host computer issues a positive pulse, the BOP increments and the DVMs take measurements on the trailing (negative-going) edge of the positive pulse. The positive pulse must be greater than 4 mS in width for this example to operate correctly.</p> <p>3. The explanation below shows how each step of the list functions once the list is entered and VOLT:MODE LIST (the last step) is executed.</p>	
LIST:CLE	Clears the list.
LIST:VOLT:APPLY LEVEL,.001,0	Establishes the list as a voltage list, output set to 0V.
LIST:DWELL:POINTS?	Returns 10. (Levels below 3 mS use 10 points.)
LIST:WAIT:HIGH 0	Maintains output at 0V, waits for Input trigger high before proceeding.
---	Host computer issues high pulse. Trigger input goes high and List proceeds to next point.
LIST:WAIT:LOW 0	Maintains output at 0V, waits for Input Trigger low before proceeding.
---	Input Trigger goes low at trailing (negative-going) edge of pulse from host commuter and List proceeds to next point. One mS after pulse issued, DVM takes measurements.
LIST:WAIT:HIGH 1.1	Sets output to 1.1V (next point in waveform), waits for Input Trigger high before proceeding.
---	Host computer issues another high pulse. Trigger input goes high and List proceeds to next point.
LIST:WAIT:LOW 1.1	Maintains output at 1.1V, waits for Input Trigger low before proceeding.
---	Input Trigger goes low at trailing (negative-going) edge of pulse from host computer and List proceeds to next point. One mS after pulse issued, DVM takes measurements.
LIST:DWELL:POINTS?	Returns the current point location (6). (Used for list:repeat.)
LIST:WAIT:HIGH 2.2	Sets output to 2.2V (next point in waveform), waits for Input Trigger high before proceeding.
---	Host computer issues another high pulse. Trigger input goes high and List proceeds to next point.
LIST:WAIT:LOW 2.2	Maintains output at 2.2V, waits for Input Trigger low before proceeding.
---	Input Trigger goes low at trailing (negative-going) edge of pulse from host computer and List proceeds to next point. One mS after pulse issued, DVM takes measurements.
LIST:DWELL:POINTS?	Returns the current point location (16).
LIST:REPEAT 6,7,3.3,4.4,5.5,6.6,7.7	Repeats step 6 and 7 (list:wait:high and list:wait:low), except each pair is set to the voltage specified in the array. This adds 10 points to the list and sets the output values of each pair to be 3.3V, 4.4V, 5.5V, 6.6V, 7.7V.
LIST:COUNT 2	Implements the waveform through two loops of the data.
LIST:DWELL:POINTS?	Returns 10.
LIST:COUNT:SKIP 10	Bypass the first step in the repeated points.
CURR 5;:OUTP ON	Set output on, output current to 5A.
---	Ensure Input Trigger is low.
VOLT:MODE LIST	Executes the above list. At each low transition of the trigger line the BOP increases its output voltage in 1.1 volt increments. The time period for each increment is controlled not by the internal clock of the BOP but rather the high-to-low edge of the pulse from the host computer. The use of LIST:WAIT:HIGH followed by LIST:WAIT:LOW ensures the BOP waits for a high-to-low edge transition on the trigger input before increasing the output.

**FIGURE B-10. USING LIST:WAIT COMMANDS TO CONTROL GENERATION OF A WAVEFORM MEASURED BY MULTIPLE EXTERNAL DEVICES USING A SINGLE EXTERNAL PULSE**

- NOTES: 1. The power supply is assumed to be operating in constant voltage mode.
2. This example assumes a BOP and a DVM is connected to a Unit Under Test (UUT). The DVM is connected to EXT\_E/ EXT\_C (pins 5/6 of the BOP External Protection port). When the BOP outputs a low EXT\_E/ EXT\_C, The DVM takes a series of measurements and places its wait line low. The DVM Wait line is connected to the Trigger Input (pin 3 of the of the BOP trigger port). When the Trigger Input goes high (indicating the DVM has completed its measurements) the BOP will advance to the next point. For this example it is assumed that the DVM will complete its measurement within 25 mS to 75 mS unless a problem is encountered. A "dead man" timer is implemented that allows up to 99 mS for the measurement to complete before automatically proceeding to the next point, thereby preventing hang-ups due to a measurement problem.
3. The explanation below shows how each step of the list functions once the list is entered and VOLT:MODE LIST (the last step) is executed.

LIST:CLE	Clear list.
LIST:SET:WAIT .0333	Set wait time to max allowed value (33 mS).
LIST:SET:TRIGGER .001,ON	Set trigger pulse width to 1 mS. Transistor across pins 5 and 6 of External Protection Port is now set off.
LIST:VOLT:APPLY LEVEL,.001,10	Create first point (10V).
LIST:DWELL:POINTS?	Returns 10.
LIST:TRIGGER 10	Maintains output at 10V, generates a 1 mS 0V trigger pulse applied to DVM, causing DVM to make measurement.
	Trigger input low while DVM makes measurement.
LIST:WAIT:HIGH 10	Wait for DVM to complete measurement for 33 mS. Proceed to next step if trigger input goes high (meaning the measurement is complete) or 33 mS elapsed, whichever comes first.
	Trigger input low while DVM makes measurement.
LIST:WAIT:HIGH 10	Wait for DVM to complete measurement for another 33 mS. Proceed to next step if trigger input goes high (meaning the measurement is complete) or 33 mS elapsed, whichever comes first
	Trigger input low while makes measurement.
LIST:WAIT:HIGH 10	Wait for DVM complete measurement for another 33 mS (these three steps allow a maximum wait time of 99 mS. Proceed to next step if trigger input goes high (meaning the measurement is complete) or 33 mS elapsed, whichever comes first.
LIST:REPEAT 10,13,20,30,40,50,60,70,80,90	Repeats steps 10 through 13 (from list:apply level to the third list:wait:high 10) for the other 8 voltages (20, 30, . . . 90).
LIST:COUNT 10	Repeat sequence ten times.
CURR 2::OUTP ON	Establishes BOP output current of 2A.
VOLT:MODE LIST	Executes the above list. A level is applied to the BOP output. One 1 mS later the transistor at EXT_E and EXT_C (pins 5 and 6 of the External Protection Port) conducts, providing a low to the DVM. The DVM immediately places the BOP trigger input low. The BOP waits for the trigger input to go high, then outputs the next level in the list. If the trigger input never goes high, the three wait statements will maintain the level for 33 mS each. After 99 mS (three wait statements) has expired, the new voltage level will be provided at the output. In this example, the pulse must be less than 1 mS. but at least 50 $\mu$ S long to insure proper operation of the program.

**FIGURE B-11. USING LIST:WAIT COMMANDS TO ALLOW AN EXTERNAL DEVICE TIME TO FUNCTION WHILE IMPOSING A MAXIMUM WAIT TIME**

**B.83 [SOURCE:]LIST:SAMPle? QUERY****LIST:SAMP?**

Syntax: Short Form: LIST:SAMP?  
 Long Form: LIST:SAMPle?  
 Returns: <INT\_VALUE>,<INT\_VALUE>....<INT\_VALUE>[V|C]

Description: **Returns a comma-separated list of numbers representing points, followed by V or C.** The point listings are determined by the settings of LIST:SAMP:CURR and LIST:SAMP:VOLT commands. The sample(s) occur after the points indicated. The type of list is indicated by V (Voltage) or C (Current). (See Figures B-8 and B-9.)

**B.84 [SOURCE:]LIST:SEGMent COMMAND****LIST:SEGM**

Syntax: Short Form: LIST:SEGM {INIT | REP} Long Form: LIST:SEGMent {INITial | REpeating]

Description: **Establishes whether waveform segment is initial (INIT) or repeating (REP) segment.** Repeating segment is executed for each cycle specified by LIST:COUN. Initial segment is executed only on the first count and skipped for all subsequent counts. Useful for preconditioning applications. All segments except the last may be set to Initial or Repeating. The last segment is always Repeating.

**B.85 [SOURCE:]LIST:SEGMent? QUERY****LIST:SEGM?**

Syntax: Short Form: LIST:SEGM? Long Form: LIST:SEGMent?  
 Return Value: {01 | 00}

Description: **Returns REP when segment is set to repeating or INIT when segment is set to initial**

**B.86 [SOURCE:]LIST:SET:SAMPle COMMAND****LIST:SET:SAMP**

Syntax: Short Form: LIST:SET:SAMP value  
 Long Form: LIST:SET:SAMPle value  
 where value = sample pulse duration, between 0.00025 and 0.034 (Seconds)

Description: **Establishes sample pulse duration.** This command must be used when measuring a sample, but must only be issued once, otherwise a -100 "command error: will result. (See Figures B-10 and B-11.)

**B.87 [SOURCE:]LIST:SET:SAMPle? QUERY****LIST:SET:SAMP?**

Syntax: Short Form: LIST:SET:SAMP? Long Form: LIST:SET:SAMPle?  
 Returns: <exp\_value>

Description: **Returns sample pulse duration.** Returns sample pulse duration set by LIST:SET:SAMP command, between 0.00025 and 0.034 Second. If sample pulse duration has not been set, error 100- "command error" results.

**B.88 [SOURCE:]LIST:SAVE COMMAND****LIST:SAVE**

Syntax: Short Form: LIST:SAVE <Name><n> Long Form: LIST:SAVE <Name><n>  
 where:  
 <Name> = 10 characters max representing the name of the waveform to be saved. Must be at least 1 character and contain no spaces. Lower case characters are automatically converted to uppercase unless included in double quotes. <n> = number from 1 to 16 representing location where waveform is to be saved.

Description: **Saves the waveform segments constructed using LIST:VOLT:APPL or LIST:CURR:APPL commands into location specified by <n> under the name specified in <Name>.** A maximum of 10 segments can be saved. LIST:SAVE saves the segments up to 10. The count specified by LIST:COUN and the operating protection limits are also saved.

### B.89 [SOURCE:]LIST:SET:TRIGger COMMAND

## LIST:SET:TRIG

Syntax: Short Form: LIST:SET:TRIG <time>,<transistor>  
Long Form: LIST:SET:TRIGger <time>,<transistor>  
<time> = 0.00025 to 0.034 (Seconds)  
<transistor> = ON or OFF

Description: **Enables the output trigger and establishes pulse-width.** Used to establish EXT\_C (pin 5) and EXT\_E (pin 6) of External Protection port as an output trigger instead of an output off flag. Once LIST:SET:TRIG is sent, these pins function as an output trigger (see Table 2-6) until LIST:CLE (PAR. B.57) is sent, restoring the function to output off flag. See Figure B-11 for example. The pulse width, between 0.00025 to 0.034 (Seconds) is established by <time>. When <transistor> = ON, the transistor across EXT PROTECT PORT pins 5 and 6 is on (conducting) while pulse is active. When <transistor> = OFF, the transistor across EXT PROTECT PORT pins 5 and 6 is off while pulse is active.

### B.90 [SOURCE:]LIST:SET:TRIGger? QUERY

## LIST:SET:TRIG?

Syntax: Short Form: LIST:SET:TRIG? Long Form: LIST:SET:TRIGger?  
Returns <value> = trigger pulse-width between 0.00025 and 0.034 Second

Description: **Returns trigger pulse-width.** If trigger pulse duration has not been set, error 100- "command error" results.

### B.91 [SOURCE:]LIST:SET:WAIT COMMAND

## LIST:SET:WAIT

Syntax: Short Form: LIST:SET:WAIT value  
Long Form: LIST:SET:WAIT value  
where:  
<value> = time-out for a wait command between 0.00025 and 0.034 Seconds

Description: **Establishes the time-out for a wait command.** If this command is not sent, the time out period will be 0 indicating an infinite wait time. (See Figures B-10 and B-11.)

### B.92 [SOURCE:]LIST:SET:WAIT? QUERY

## LIST:SET:WAIT?

Syntax: Short Form: LIST:SET:WAIT? Long Form: LIST:SET:WAIT?  
Returns <value> = time-out for a wait command between 0.00025 and 0.034 Second

Description: Returns the time-out for a wait command. Returns 0 if LIST:SET:WAIT not sent, indicating infinite wait time.

### B.93 [SOURCE:]LIST:TRIGger COMMAND

## LIST:TRIG

Syntax: Short Form: LIST:TRIG <value>  
Long Form: LIST:TRIGger <value>  
where:  
<value> = programmed current (Amps) for current list, or programmed voltage (Volts) for voltage list.

Description: **Similar to LIST:VOLT or LIST:CURR, except also allows Output Off flag of External Protection Port to be used to trigger an external device.** In addition to setting the output to the <value> specified (for duration established by LIST:SET:TRIG), causes the Output Off flag transistor (EXT\_E, pin 5, and EXT\_C, pin 6, of the External Protection port) to be set to the state (on or off) for the duration set by the LIST:SET:TRIG command.

If the trigger duration is not established by the LIST:SET:TRIG command, a -221 "Settings conflict" error results. This command must be preceded by LIST:CURR or LIST:VOLT command, otherwise a -221 "Settings conflict" error results. The entries on the dwell list must match the values on the current or voltage list, otherwise a -226 "Lists Not Same Length" error results. (See Figure B-11.)

## B.94 [SOURCE:]LIST:VOLTage COMMAND

## LIST:VOLT

Short Form: LIST:VOLT[:LEV] <exp\_value>, <exp\_value>, . . . (to max of 5900 data points)

Long Form: LIST:VOLTage[:LEVel] <exp\_value>, <exp\_value>, . . . (to max of 5900 data points)  
<exp\_value> = digits with decimal point and Exponent, e.g., 2.71E1 for 27.1

Description: **Adds the voltage value (in Volts) to list.** This command sequentially adds LIST:VOLTage values to the main channel List Data Table locations illustrated in Table B-3. LIST:CLe sets starting location to 0. Next location indicated by LIST:VOLT:POIN?. The maximum number of entries is 2950, 3933, or 5900. Since the input buffer of the BOP has a limit of 253 characters, multiple commands are necessary to complete the full 5900 entries of the list. If LIST:CURR has any entries, an error message: -221, "Settings conflict" is posted in the error queue. Related Commands: LIST:VOLT:POIN?, FUNC:MODE, LIST:CLe, \*RST. (See example, Figure B-6.)

## B.95 [SOURCE:]LIST:VOLTage? QUERY

## LIST:VOLT?

Syntax: Short Form: LIST:VOLT? Long Form: LIST:VOLTage?

Return Value: <value1>, <value2>, . . . to <value16>

Description: **Identifies the parameters (main channel) entered for the list.** Starting at location established by LIST:QUERy, returns comma-separated list of up to 16 values indicating the main channel parameters entered. i.e., the contents of the main channel locations of Table B-3. Related Commands: LIST:VOLT, LIST:QUERy. If LIST:CURR has any entries, an error message: -221, "Settings conflict" is posted in the error queue. (See example, Figure B-6.)

## B.96 [SOURCE:]LIST:VOLTage:APPLy COMMAND

## LIST:VOLT:APPL

Syntax: Short Form: LIST:VOLT:APPL <type>,<value1>,<value2>[,<value3>]

Long Form: LIST:VOLTage:APPLy <type>,<value1>,<value2>[,<value3>]

Where <type> is {SQUARe | RAMP+ | RAMP- | TRIangle | SINE | LEVel | SLOPe | ZINCrement | ZDECrement}

<value1> is frequency in Hz, except for the following:

LEVel: period (duration) in seconds

SLOPe: period (duration) in seconds

ZINCrement or ZDECrement: number of steps

<value2> is p-p amplitude in Volts, except for the following:

LEVel: amplitude (offset) in Volts

SLOPe: starting amplitude in Volts

ZINCrement: not supported

ZDECrement: not supported

<value3> is offset (optional, default is 0, not applicable to LEVel, ZINCrement, ZDECrement or End point for SLOPe type segments.

NOTES:1. <value2> is optional for all <types> except SLOPe, ZINC and ZDEC.

2. ZDINC and ZDEC are allowed only in the first segment, but are allowed in the second segment if ZINC and ZDEC are also present in the first segment.

Description: **Causes the unit to add a series of points to both the list:volt array and the list:dwel array to make either a level or a waveform segment of one of six types.** Refer to table 3-12 for a description of the waveform types and frequency limits. Maximum number of segments in a waveform is 100.

Except as noted below, the waveform type specified is generated at the frequency specified with a peak-to-peak amplitude centered on zero.

If the optional offset value is specified, the center of the generated series of points is moved off zero to the offset amplitude specified. This applies to offset of sine, triangle,  $\pm$ ramp, and square waveforms and to Level waveform amplitude.

For LEVel, sets the output to amplitude of <value2> which remains for the entire segment time specified by <value1>.

For SLOPe the segment begins with the start point <value2>. If <value2> not provided, segment begins with the previous segments last level or 0 if there was no prior segment. The segment ends at time specified by <value 1> at the end level specified by <value3>. Slope is like RAMP+ and RAMP- with the ramp specified as start and end points and time versus amplitude and offset and frequency.

ZDECrement and ZINCrement allow the segments that follow to be repeated for a number of steps with varying amplitude. See Figures B-12 and B-13 for examples. <value 1> is the number of steps, from 3 (minimum) to 50 (maximum), specifying the number of times the repeating waveform segments are repeated. ZDEC or ZINC must be the first segment(s) in a waveform. If ZDEC or ZINC is the first segment, then another ZINC or ZDEC is allowed in the second segment.

- NOTES: 1. The power supply is assumed to be operating in constant voltage mode.  
2. VOLT:MODE LIST (the last step) is executed.

LIST:CLEAR	
LIST:COUNT 1	1 cycle
LIST:VOLT:APPL ZINC,11	The repeating waveform segment will be repeated eleven times. Amplitude of each repeated cycle will increase from zero.
LIST:VOLT:APPL ZDEC,11	The next waveform segment will be repeated eleven times. Amplitude of each repeated cycle will decrease to zero.
LIST:VOLT:POIN?	Unit returns 22 representing the 22 multipliers
	--- The next three commands create a $\pm 10V$ square wave using two levels.
LIST:SEGM REPEAT	Specifies the following segments are to be repeated.
LIST:VOLT:APPL LEV,0.05,10	Positive value of square wave, duration: 0.05 seconds, amplitude: 10V,
LIST:VOLT:APPL LEV,0.05,-10	Negative part of the square wave
LIST:VOLT:POIN?	Unit returns 82. Subtracting 22 shows the unit is using 60 points for the repeating segments.
VOLT:MODE LIST	The list is executed once (see Figure B-13. Each cycle of the output square wave is comprised of two levels: +10V, and -10V. Both levels are repeating segments. LIST:VOLT:APPL ZINC,11 causes the two levels to be executed 11 times, each cycle increasing in amplitude. The first cycle is zero. The second cycle outputs +1V followed by a -1V level, followed by $\pm 2V$ , $\pm 3V$ , $\pm 4V$ , $\pm 5V$ , $\pm 6V$ , $\pm 7V$ , $\pm 8V$ , $\pm 9V$ and $\pm 10V$ cycles. Then LIST:VOLT:APPL ZDEC,11 outputs 11 cycles that decrease in amplitude from 10V to 0V. ZINC and ZDEC both work by applying a multiplier to the amplitude of each successive step. For the increasing waveform (ZINC) the amplitude multiplier for the first step is 0. The following step is multiplied by a fraction calculated by $1/(\text{number of steps} - 1)$ . The next step (step 2) is calculated as $2/(11 - 1) = 0.2$ . This is repeated for all the steps, with the multiplier for last step (step 11) calculated as $11/11 - 1 = 1$ . ZDEC functions similarly, starting with a multiplier of 1 and ending with 0.

**FIGURE B-12. USING ZDEC AND ZINC WITH LIST:VOLT:APPL COMMAND**

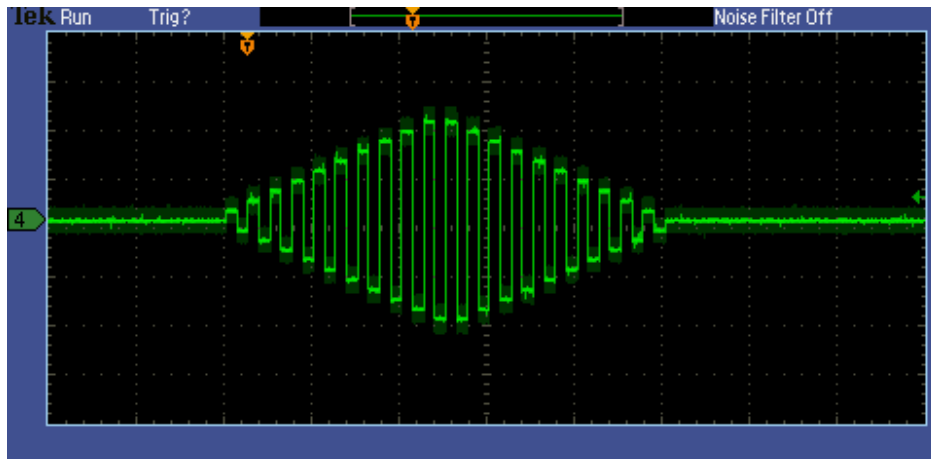

**FIGURE B-13. SQUARE WAVE USING LIST:VOLT:APPL ZINC AND LIST:VOLT:APPL ZDEC WITH ELEVEN STEPS EACH (ZERO PLUS 10 NON-ZERO VALUES)**

**B.97 [SOURce:]LIST:VOLTage:APPLy:SWEep COMMAND LIST:VOLT:APPL:SWE**

Syntax: Short Form: LIST:VOLT:APPL:SWE <>,  
 Long Form: LIST:VOLTage:APPLy:SWEep <value1>,<value2>  
 Where <value1> is start angle. Valid from 0 to 359.99 degrees.  
 <value2> is stop angle. Valid from 0.01 to 360.00 degrees

Description: **Allows the user to provide a starting angle for either triangle and sine waveforms and an optional stop angle.** If the stop angle is not supplied, the unit defaults to 360 degrees. This command should be placed at the beginning of the waveform program to be applicable to all sine and triangle waveform segments.

**B.98 [SOURce:]LIST:VOLTage:APPLy:SWEp? QUERY LIST:VOLT:APPL:SWE?**

Syntax: Short Form: LIST:VOLT:APPL:SWE? Long Form: LIST:VOLTage:APPLy:SWEp?  
 Return Value: <value1>, <value2>(0.01 to 360)

Description: **Returns start <value1> and stop <value2> angle in degrees for either triangle and sine waveforms.**

**B.99 [SOURce:]LIST:VOLTage:POINts? QUERY LIST:VOLT:POIN?**

Syntax: Short Form: LIST:VOLT:POIN? Long Form: LIST:VOLTage:POINts?  
 Return Value: <n> where n = number of points used

Description: **Identifies the total number of points in a list and the next location to be filled by LIST:VOLT command.** The LIST:VOLT pointer is initially at 0 via LIST:CLE. For each data point entered by a LIST:VOLT command the list pointer is incremented. If LIST:VOLT:POIN? returns 5, the LIST:VOLT pointer is at 5 indicating there are 5 data points comprising the list (locations 0 though 4) and location 5 is the next to be filled. If LIST:CURR has any entries, an error message: -221,"Settings conflict" is posted in the error queue. Related Commands: LIST:VOLT. (See example, Figure B-6.)

## B.100 [SOURCE:]LIST:WAIT:HIGH COMMAND

## LIST:WAIT:HIGH

Syntax: Short Form: LIST:WAIT:HIGH value  
Long Form: LIST:WAIT:HIGH value  
where:

<value> = programmed current (Amps) for current list, or programmed voltage (Volts) for voltage list.

Description: **Waits for the trigger input to go high before advancing to next step.** When the command is executed the output is immediately set to the <value>. Pins 1 (GND) and 3 of the Trigger Port are used as the input trigger. If the trigger input is high (TTL logic 1 or open circuit) and a wait time has been established by LIST:SET:WAIT, the step is immediately skipped. If the trigger input is low (TTL logic 0 or short-circuit), the unit will proceed to the next step when either a) the trigger input goes high or b) the wait time expires (non-zero wait values only), whichever comes first. If the wait time is 0, the unit must wait until the trigger input goes high before proceeding to the next step.

In all cases, the trigger input must be high or low for at least 0.4 mS to be considered stable. This 0.4 mS delay provides a noise filter to insure only a level causes the output change.

This command must be preceded by LIST:CURRE or LIST:VOLT command, otherwise a -221 "Settings Conflict" error results. The entries of the dwell list must match the values in the current or voltage list, otherwise a -226 "Lists Not Same Length" error results. (See Figures B-10 and B-11.)

## B.101 [SOURCE:]LIST:WAIT:LEDGE COMMAND

## LIST:WAIT:LEDG

Syntax: Short Form: LIST:WAIT:LEDG value  
Long Form: LIST:WAIT:LEDGe value  
where:

<value> = programmed current (Amps) for current list, or programmed voltage (Volts) for voltage list.

Description: **Waits for the leading edge of the trigger input to go low before proceeding to the next step.** If the trigger input is already low, the signal must go high then low for the leading edge to be accepted. When the command is executed the output is immediately set to the <value>. Pins 1 (GND) and 3 of the Trigger Port are used as the input trigger. If the trigger input goes from high to low (TTL logic 0 or short-circuit) and a wait time has been established by LIST:SET:WAIT, the unit will proceed to the next step when either a) the trigger input goes low or b) the wait time expires (non-zero wait values only), whichever comes first. If the wait time is 0, the unit must wait until the trigger input goes from high to low before proceeding to the next step.

This command must be preceded by LIST:CURRE or LIST:VOLT command, otherwise a -221 "Settings Conflict" error results. The entries of the dwell list must match the values in the current or voltage list, otherwise a -226 "Lists Not Same Length" error results. (See Figure B-14.)

## B.102 [SOURCE:]LIST:WAIT:LOW COMMAND

## LIST:WAIT:LOW

Syntax: Short Form: LIST:WAIT:LOW value  
Long Form: LIST:WAIT:LOW value  
where:

<value> = programmed current (Amps) for current list, or programmed voltage (Volts) for voltage list.

Description: **Waits for the trigger input to go low before advancing to next step.** When the command is executed the output is immediately set to the <value>. Pins 1 (GND) and 3 of the Trigger Port are used as the input trigger. If the trigger input is low (TTL logic 0 or short-circuit) and a wait time has been established by LIST:SET:WAIT, the step is immediately skipped. If the trigger input is high (TTL logic 1 or open circuit), the unit will proceed to the next step when either a) the trigger input goes low or b) the wait time expires (non-zero wait values only), whichever comes first. If the wait time is 0, the unit must wait until the trigger input goes low before proceeding to the next step.

In all cases, the trigger input must be high or low for at least 2  $\mu$ S to be considered stable. This 2  $\mu$ S delay provides a noise filter to insure only a level causes the output change.

This command must be preceded by LIST:CURRE or LIST:VOLT command, otherwise a -221 "Settings Conflict" error results. The entries of the dwell list must match the values in the current or voltage list, otherwise a -236 "Lists Unbalanced" error results. (See Figures B-10 and B-11.)



<p>NOTES: 1. The power supply is assumed to be operating in constant voltage mode.</p> <p>2. The WAIT commands provide a method to synchronize multiple instruments to a common control pulse. This example assumes BOP and a number of switching DVMs are connected to a Unit Under Test (UUT). The DVMs are programmed to wait 1 mS after a low-going edge is received from the host computer, then take a few measurements. The same low-going edge is applied to the Trigger Input (pin 3 of the BOP Trigger Port); the negative-going edge of this pulse will cause the BOP to increment the output to the next level. Thus, each time the host computer issues a positive pulse, the BOP increments and the DVMs take measurements on the trailing (negative-going) edge of the positive pulse. The positive pulse can be very short with this functionality (see Table 1-2, Programming/Display Characteristics - Trigger port - Output On-Off Control Input for minimum pulse width).</p> <p>3. The explanation below shows how each step of the list functions once the list is entered and VOLT:MODE LIST (the last step) is executed.</p>	
LIST:CLE	Clears the list.
LIST:VOLT:APPLY LEVEL, .001,0	Establishes the list as a voltage list, output set to 0V.
LIST:DWELL:POINTS?	Returns 10. (Wait of 33 mS uses 10 points.)
LIST:WAIT:LEDGE 0	Maintains output at 0V, waits for Input trigger to have a high to low edge before proceeding.
<p>--- Host computer issues high pulse. Input Trigger goes low at trailing (negative-going) edge of pulse from host computer and List proceeds to next point. One mS after pulse issued, DVM takes measurements.</p>	
LIST:DWELL:POINTS?	Returns the current point location (3). (Used for list:repeat.)
LIST:REPEAT 9,10,1.1,2.2,3.3,4.4,5.5,6.6,7.7	Repeats step 9 and 10 (list:volt:apply lev and list:wait:ledge), except each pair is set to the voltage specified in the array. This adds 14 points to the list and sets the output values of each pair to be 1.1V, 2.2V, 3.3V, 4.4V, 5.5V, 6.6V and 7.7V.
LIST:COUNT 2	Implements the waveform through two loops of the data.
CURR 5;:OUTP ON	Set output on, output current to 5A.
VOLT:MODE LIST	Executes the above list. At each high-to-low transition of the Trigger Port input, the BOP increases its output voltage in 1.1 volt increments. The duration of each increment is not controlled by the internal clock of the BOP, but instead by the high-to-low edge of the pulse from the host computer.

**FIGURE B-14. USING LIST:WAIT COMMANDS TO CONTROL GENERATION OF A WAVEFORM MEASURED BY MULTIPLE EXTERNAL DEVICES USING THE LOW-GOING LEADING EDGE OF AN EXTERNAL PULSE**

**B.103 [SOURce:]VOLTage[:LEVel][:IMMEDIATE][:AMPLitude] COMMAND**

**VOLT**

Syntax: Short Form: [SOUR:]VOLT[:LEV][:IMM][:AMP] <exp\_value>  
 Long Form: [SOURce:]VOLTage[:LEVel][:IMMEDIATE][:AMPLitude] <exp\_value>  
 <exp\_value> = digits with decimal point and Exponent, e.g., 2.71E1 for 27.1

Description: **Sets programmed voltage level at power supply output.** This command programs output voltage to a specific value; actual output voltage will depend on load conditions. If the value exceeds the maximum for the model being programmed, error message -222, "Data out of range" is posted in output queue. (See example, Figure B-1.)

**B.104 [SOURce:]VOLTage[:LEVel][:IMMEDIATE][:AMPLitude]? QUERY**

**VOLT?**

Syntax: Short Form: [SOUR:]VOLT[:LEV][:IMM][:AMP]? {MIN | MAX}  
 Long Form: [SOURce:]VOLTage[:LEVel][:IMMEDIATE][:AMPLitude]? {MIN | MAX}

Description: **Identifies programmed voltage, maximum allowable voltage, or minimum voltage.** The VOLT? query returns the programmed value of voltage. Actual output voltage will depend on load conditions. The VOLT?MAX query returns the maximum voltage allowed for a particular model. VOLT? MIN returns minimum voltage allowed for power supply (always negative). **Related Commands:** VOLT. (See example, Figure B-1.)

**B.105 [SOURce:]VOLTage[:LEVel]:LIMit[:BOTH] COMMAND****VOLT:LIM[:BOTH]**

Syntax: Short Form: [SOUR:]VOLT[:LEV]:LIM[:BOTH] <value>  
 Long Form: [SOURce:]VOLTage[:LEVel]:LIMit[:BOTH] <value>  
 where <value> is between zero and rated (nominal) output voltage

Description: Establishes the software limit <value> for output voltage, i.e., sets the maximum value of positive or negative output voltage that the unit will be allowed to produce. Requires MEM:UPD (PAR. B.20) to save for power up. See PAR. 3.5.2.2 and Figure 3-17 for special programming considerations.

**B.106 [SOURce:]VOLTage[:LEVel]:LIMit[:BOTH]? QUERY****VOLT:LIM[:BOTH]?**

Syntax: Short Form: [SOUR:]VOLT[:LEV]:LIM[:BOTH]?  
 Long Form: [SOURce:]VOLTage[:LEVel]:LIMit[:BOTH]?  
 Returns <value>

Description: Identifies the software limit value for both positive and negative output voltage specified by the user.

**B.107 [SOURce:]VOLTage[:LEVel]:LIMit:NEGative COMMAND****VOLT:LIM:NEG**

Syntax: Short Form: [SOUR:]VOLT[:LEV]:LIM:NEG <value>  
 Long Form: [SOURce:]VOLTage[:LEVel]:LIMit:NEGative <value>  
 where <value> is between zero and rated (nominal) output voltage

Description: Establishes the software limit <value> for negative output voltage, i.e., sets the maximum value of negative output voltage that the unit will be allowed to produce. Requires MEM:UPD (PAR. B.20) to save for power up. See PAR. 3.5.2.2 and Figure 3-17 for special programming considerations.

**B.108 [SOURce:]VOLTage[:LEVel]:LIMit:NEGative? QUERY****VOLT:LIM:NEG?**

Syntax: Short Form: [SOUR:]VOLT[:LEV]:LIM:NEG? <value>  
 Long Form: [SOURce:]VOLTage[:LEVel]:LIMit:NEGative? <value>

Description: Identifies the software limit value for negative output voltage specified by the user.

**B.109 [SOURce:]VOLTage[:LEVel]:LIMit:POSitive COMMAND****VOLT:LIM:POS**

Syntax: Short Form: [SOUR:]VOLT[:LEV]:LIM:POS <value>  
 Long Form: [SOURce:]VOLTage[:LEVel]:LIMit:POSitive <value>  
 where <value> is between zero and rated (nominal) output voltage

Description: Establishes the software limit <value> for positive output voltage, i.e., sets the maximum value of positive output voltage that the unit will be allowed to produce. Requires MEM:UPD (PAR. B.20) to save for power up. See PAR. 3.5.2.2 and Figure 3-17 for special programming considerations.

**B.110 [SOURce:]VOLTage[:LEVel]:LIMit:POSitive? QUERY****VOLT:LIM:POS?**

Syntax: Short Form: [SOUR:]VOLT[:LEV]:LIM:POS? <value>  
 Long Form: [SOURce:]VOLTage[:LEVel]:LIMit:POSitive? <value>

Description: Identifies the software limit value for positive output voltage specified by the user.

**B.111 [SOURce:]VOLTage:MODE COMMAND****VOLT:MODE**

Syntax: Short Form: [SOUR:]VOLT:MODE (FIX | LIST | TRAN <nn> | EXT | GAIN | PROT | HALT)  
 Long Form: [SOURce:]VOLTage:MODE (FIXed | LIST | TRANsient <nn> | EXTernal | GAIN | PROTect | HALT)  
 nn = <value> = time in Seconds for transient (from 0.0005 to 2)

Description: **Allows the user to execute or stop a list, to execute a transient, or to use an external reference in voltage or current mode of operation.** The default mode is FIXed: the power supply executes commands normally, and LIST commands can be issued to establish the parameters and sequence of a list. This command affects the *main channel*, whether voltage or current.

When VOLT:MODE LIST is issued, a list is executed (See LIST commands and Figure B-6). While the list is being executed, all output and list change commands except CURR:MODE FIXed and VOLT:MODE:FIXed are not accepted and will produce a command or settings conflict error.

Issuing VOLT:MODE FIX while the list is running will stop the execution of the list and return power supply to settings in effect prior to running the list. If the list runs to completion, the settings of the last step of the list will be in effect.

Issuing VOLT:MODE HALT while the list is running will stop the execution of the list at the end of the current cycle.

VOLT:MODE TRAN nn causes the next VOLT: or CURR: command to produce a transient pulse of

nn Seconds duration, after which the voltage returns to original value. E.g., VOLT:25 sets the output to 25 volts, and VOLT:MODE TRAN 0.1 primes the unit for a transient of 0.1 Seconds. When VOLT:10 is issued, the power supply output goes to 10V for 0.1 Seconds. Similarly, sending VOLT:TRIG 14, VOLT:MODE TRAN .05 and \*TRG causes the output to go to 14V for 0.05 Seconds. If the time nn exceeds 2 Seconds, error message -222 “dwell or frequency out range” is posted to the error queue.

VOLT:MODE EXT Configures the unit to use an external reference to change the main channel, whether voltage or current (see PAR. 3.4);  $\pm 10V$  reference produces output =  $\pm E_o$  (rated) (Fixed gain =  $E_o$  (rated)). Identical to CURR:MODE EXT.

VOLT:MODE GAIN Configures the unit to use an external reference to provide a proportional output voltage (see PAR. 3.4.4.2).

VOLT:MODE PROT - allows VOLT command to accept values up to the protection limits of the power supply without generating an error. For example for a BOP 36-56MG in voltage mode, after sending VOLT:MODE PROT, sending VOLT 36.4 would set the protection levels to 36.4 and main channel level to 36.

**Related Commands:** VOLT, LIST commands. (See example, Figure B-6.)

**B.112 [SOURce:]VOLTage:MODE? QUERY**

**VOLT:MODE?**

Syntax: Short Form: [SOUR:]VOLT[:LEV]:MODE?  
 Long Form: [SOURce:]VOLTage[:LEVel]:MODE?  
**Return value:** FIX, LIST, TRANS, EXT, or GAIN

Description: **Identifies active voltage mode.** See PAR. B.111 for further details **Related Commands:** LIST commands. (See example, Figure B-6.)

**B.113 [SOURce:]VOLTage[:LEVel]:PROTect:BOTH COMMAND**

**VOLT:PROT[:BOTH]**

Syntax: Short Form: [SOUR:]VOLT[:LEV]:PROT[:BOTH] <value>  
 Long Form: [SOURce:]VOLTage[:LEVel]:PROTect[:BOTH] <value>  
 where <value> is between minimum (box) value (Figure 1-3) and 1% above rated (nominal) output voltage.

Description: Establishes the both the positive and negative protection limits for voltage. If the protection limits are not identical the unit automatically reduces the appropriate limit (see Figure B-15).

**B.114 [SOURce:]VOLTage[:LEVel]:PROTect[:BOTH]? QUERY**

**VOLT:PROT[:BOTH]?**

Syntax: Short Form: [SOUR:]VOLT[:LEV]:PROT[:BOTH]?  
 Long Form: [SOURce:]VOLTage[:LEVel]:PROTect[:BOTH]?  
 Returns <exp\_value>,<exp\_value>

Description: Identifies the protection limits for voltage (positive, negative); maximum is 1% greater than rated output voltage.

<b>NOTE:</b> The power supply is assumed to be operating in constant voltage mode.	
VOLT:PROTECT:LIMIT:POS 5	Sets positive voltage protection limit to +5V.
VOLT:PROTECT:LIMIT:NEG 15	Sets negative voltage protection limit to -15V.
VOLT:PROTECT 10	Attempts to set voltage protection levels to $\pm 10V$ . No error generated.
VOLT:PROT:POS?	Returns 5 (positive voltage protection set to +5V since 5 is less than 10.
VOLT:PROT:NEG?	Returns 10 (negative voltage protection set to -10V.
VOLT:PROTECT 18	Sets both voltage protection limits to +18V. No error generated.
VOLT:PROT:POS?	Returns 5 (positive voltage protection set to +5V since 5 is less than 18.
VOLT:PROT:NEG?	Returns 15 (negative voltage protection set to -15V, since 15 is less than 18

**FIGURE B-15. USING PROT:LIM:POS AND PROT:LIM:POS COMMANDS TO SET ASYMMETRICAL LIMITS**

### **B.115 [SOURCE:]VOLTage[:LEVel]:PROTect:MODE COMMAND** **VOLT:PROT:MODE**

Syntax: Short Form: [SOURCE:]VOLT[:LEV]:PROT:MODE (EXT | FIX | LESS | )  
Long Form: [SOURCE:]VOLTage[:LEVel]:PROTect:MODE (EXTernal | FIXed | LESSer | )  
Description: Determines how voltage protection limits are controlled in voltage or current mode of operation.  
FIXED - Allows the limits to be controlled by digital signals from either the keypad (if the unit is in local mode) or SCPI command (if the unit is in remote mode).  
EXTERNAL: Allows both current and voltage limits to be controlled by analog signals applied to the analog port; limits set from the keypad or SCPI command have no effect (see PAR. 3.4.5).  
LESSER LIMIT: Allows protect limit to be automatically selected from either 1) the external analog voltage applied to the Analog I/O port or 2) the value set from the keypad or SCPI command). Whichever limit has a lower absolute value (closest to zero) has effect

### **B.116 [SOURCE:]VOLTage[:LEVel]:PROTect:MODE? QUERY** **VOLT:PROT:MODE?**

Syntax: Short Form: [SOURCE:]VOLT[:LEV]:PROT:MODE?  
Long Form: [SOURCE:]VOLTage[:LEVel]:PROTect:MODE?  
Returns: FIX, EXT or LESS  
Description: Identifies how voltage protection limits are controlled: FIX for Fixed, EXT for external, LESS for the lesser of the internal (fixed) and external protection limit values (See PAR. B.115 for details).

### **B.117 [SOURCE:]VOLTage[:LEVel]:PROTect:NEGative COMMAND** **VOLT:PROT:NEG**

Syntax: Short Form: [SOURCE:]VOLT[:LEV]:PROT:NEG <exp\_value>  
Long Form: [SOURCE:]VOLTage[:LEVel]:PROTect:NEGative <exp\_value>  
where <value> is between minimum (box) value (Figure 1-3) and 1% above rated (nominal) output voltage.  
Description: Establishes the negative protection limit for voltage; maximum is 1% greater than rated output voltage.

### **B.118 [SOURCE:]VOLTage[:LEVel]:PROTect:NEGative? QUERY** **VOLT:PROT:NEG?**

Syntax: Short Form: [SOURCE:]VOLT[:LEV]:PROT:NEG?  
Long Form: [SOURCE:]VOLTage[:LEVel]:PROTect:NEGative?  
Returns: <exp\_value>  
Description: Identifies the negative protection limit for voltage.

### **B.119 [SOURCE:]VOLTage[:LEVel]:PROTect:POSitive COMMAND** **VOLT:PROT:POS**

Syntax: Short Form: [SOURCE:]VOLT[:LEV]:PROT:POS <exp\_value>  
Long Form: [SOURCE:]VOLTage[:LEVel]:PROTect:POSitive <exp\_value>  
where <value> is between minimum (box) value (Figure 1-3) and 1% above rated (nominal) output voltage.  
Description: Establishes the positive protection limit for voltage; maximum is 1% greater than rated output voltage.

### **B.120 [SOURCE:]VOLTage[:LEVel]:PROTect:POSitive? QUERY** **VOLT:PROT:POS?**

Syntax: Short Form: [SOURCE:]VOLT[:LEV]:PROT:POS?  
Long Form: [SOURCE:]VOLTage[:LEVel]:PROTect:POSitive?  
Returns: <exp\_value>  
Description: Identifies the positive protection limit for voltage.

### **B.121 [SOURCE:]VOLTage[:LEVel]:PROTect:LIMit:BOTH COMMAND** **VOLT:PROT:LIM[:BOTH]**

Syntax: Short Form: [SOURCE:]VOLT[:LEV]:PROT:LIMit[:BOTH] <value>  
Long Form: [SOURCE:]VOLTage[:LEVel]:PROTect:LIM[:BOTH] <value>  
where <value> is between minimum (box) value (Figure 1-3) and 1% above rated (nominal) output voltage.  
Description: Establishes the maximum value possible for both the positive and negative protection limits for voltage. Requires MEM:UPD (PAR. B.20) to save for power up. See PAR. 3.5.3.3 and Figure 3-17 for special programming considerations.

**B.122 [SOURCE:]VOLTage[:LEVel]:PROTect:LIMit[:BOTH]? QUERY**  
**VOLT:PROT:LIM[:BOTH]?**

Syntax: Short Form: [SOUR:]VOLT[:LEV]:PROT:LIM[:BOTH]?  
Long Form: [SOURCE:]VOLTage[:LEVel]:PROTect:LIMit[:BOTH]?  
Returns <exp\_value>,<exp\_value>

Description: Identifies the maximum value possible for protection limits for voltage (positive, negative); maximum is 1% greater than rated output voltage.

**B.123 [SOURCE:]VOLTage[:LEVel]:PROTect:LIMit:NEGative COMMAND**  
**VOLT:PROT:LIM:NEG**

Syntax: Short Form: [SOUR:]VOLT[:LEV]:PROT:LIM:NEG <exp\_value>  
Long Form: [SOURCE:]VOLTage[:LEVel]:PROTect:LIMit:NEGative <exp\_value>  
where <value> is between minimum (box) value (Figure 1-3) and 1% above rated (nominal) output voltage.

Description: Establishes the minimum (maximum absolute) value possible for the negative protection limit for voltage. This may be set up to 1% greater than rated voltage. Requires MEM:UPD (PAR. B.20) to save for power up. See PAR. 3.5.3.3 and Figure 3-17 for special programming considerations.

**B.124 [SOURCE:]VOLTage[:LEVel]:PROTect:LIMit:NEGative? QUERY**  
**VOLT:PROT:LIM:NEG?**

Syntax: Short Form: [SOUR:]VOLT[:LEV]:PROT:LIM:NEG?  
Long Form: [SOURCE:]VOLTage[:LEVel]:PROTect:LIMit:NEGative?  
Returns: <exp\_value>

Description: Identifies the minimum (maximum absolute) value possible for the negative protection limit for voltage.

**B.125 [SOURCE:]VOLTage[:LEVel]:PROTect:LIMit:POSitive COMMAND**  
**VOLT:PROT:LIM:POS**

Syntax: Short Form: [SOUR:]VOLT[:LEV]:PROT:LIM:POS <exp\_value>  
Long Form: [SOURCE:]VOLTage[:LEVel]:PROTect:LIMit:POSitive <exp\_value>  
where <value> is between minimum (box) value (Figure 1-3) and 1% above rated (nominal) output voltage.

Description: Establishes the maximum value possible for the positive protection limit for voltage. This may be set up to 1% greater than rated voltage. Requires MEM:UPD (PAR. B.20) to save for power up. See PAR. 3.5.2.2 and Figure 3-17 for special programming considerations.

**B.126 [SOURCE:]VOLTage[:LEVel]:PROTect:LIMit:POSitive? QUERY**  
**VOLT:PROT:LIM:POS?**

Syntax: Short Form: [SOUR:]VOLT[:LEV]:PROT:LIM:POS?  
Long Form: [SOURCE:]VOLTage[:LEVel]:PROTect:LIMit:POSitive?  
Returns: <exp\_value>

Description: Identifies the maximum value possible for the positive protection limit for voltage.

**B.127 [SOURCE:]VOLTage[:LEVel]:TRIGgered[:AMPLitude] COMMAND**  
**VOLT:TRIG**

Syntax: Short Form: [SOUR:]VOLT[:LEV]:TRIG[:AMP] <exp\_value>  
Long Form: [SOURCE:]VOLTage[:LEVel]:TRIGgered[:AMPLitude] <exp\_value>  
<exp\_value> = digits with decimal point and Exponent, e.g., 2.71E1 for 27.1

Description: **Programs voltage value to be transferred to output by \*TRG command.** Actual output voltage will depend on load conditions. If the value exceeds the maximum for the model being programmed, error message -222, "Data out of range" is posted in output queue. If value exceeds VOLT:LIM:HIGH value, a value corresponding to the voltage limit will be programmed.

**B.128 [SOURCE:]VOLTage[:LEVel]:TRIGgered[:AMPLitude]? QUERY**  
**VOLT:TRIG?**

Syntax: Short Form: [SOUR:]VOLT[:LEV]:TRIG[:AMP]?  
Long Form: [SOURCE:]VOLTage[:LEVel]:TRIGgered[:AMPLitude]?  
**Return Value:** <exp\_value> = digits with decimal point and Exponent, e.g., 2.71E1 for 27.1

Description: **Returns value representing voltage value to be programmed by \*TRG command established by VOLT:TRIG command).**

**B.129 STATus:OPERation:CONDition? QUERY**

**STAT:OPER:COND?**

Syntax: Short Form: STAT:OPER:COND? Long Form: STATus:OPERation:CONDition?  
 Return Value: <int\_value>

Description: **Returns the value of the Operation Condition Register (see Table B-4).** The Operation Condition Register contains unlatched real-time information about the operating conditions of the power supply. Bit set to 1 = function enabled (active, true); bit reset to 0 = function disabled (inactive, false). (See example, Figure B-16.)

**TABLE B-4. OPERATION CONDITION REGISTER, OPERATION ENABLE REGISTER, AND OPERATION EVENT REGISTER BITS**

CONDITION	NU	LR	NU	LC	SC	CC	TC	CV	NU	TA	WTG	NU	STL	NU
BIT	15	14	13	12	11	10	9	8	7	6	5	4-2	1	0
VALUE	32,768	16,384	8192	4096	2048	1024	512	256	128	64	32	16-4	2	1

CC Constant Current Mode  
 CV Constant Voltage Mode  
 LC List Complete  
 LR List Running  
 NU Not Used  
 SC Sample Complete  
 STL Settling  
 TC Transient Complete  
 TA Transient Armed  
 WTG Waiting For Trigger

**B.130 STATus:OPERation:ENABLE COMMAND**

**STAT:OPER:ENAB**

Syntax: Short Form: STAT:OPER:ENAB <int\_value>  
 Long Form: STATus:OPERation:ENABLE <int\_value>

Description: **Sets Operation Enable Register.** The Operation Enable Register is a mask for enabling specific bits in the Operation Event Register which will cause the operation summary bit (bit 7) of the Status Byte register to be set Bit set to 1 = function enabled (active, true); bit reset to 0 = function disabled (inactive, false). The operation summary bit is the logical OR of all the enabled bits in the Operation Event register. (See example, Figure B-16.)

**B.131 STATus:OPERation:ENABLE? QUERY**

**STAT:OPER:ENAB?**

Syntax: Short Form: STAT:OPER:ENAB? Long Form: STATus:OPERation:ENABLE?  
 Return Value: <int\_value>

Description: **Reads Operation Enable Register (see Table B-4).** Returns value of Operation Enable Register bits. Bit set to 1 = function enabled (active, true); bit reset to 0 = function disabled (inactive, false). (See example, Figure B-16.)

**B.132 STATus:OPERation[:EVENTi] QUERY**

**STAT:OPER?**

Syntax: Short Form: STAT:OPER[:EVEN]? Long Form: STATus:OPERation[:EVENT]?  
 Return Value: <int\_value>

Description: **Indicates changes in conditions monitored by Operational Event Register (see Table B-4).** Returns the value of the Operation Event register. The Operation Event register is a read-only register which holds (latches) all events that occur. Reading the Operation Event register clears it. (See example, Figure B-16.)

**B.133 STATus:PRESet COMMAND**

**STAT:PRES**

Syntax: Short Form: STAT:PRES Long Form: STATus:PRESet

Description: **Disables reporting of all status events.** This command sets the Operation Enabled Register (Table B-4) to 8193 and the Questionable Register to 255. (See example, Figure B-16.)

**B.134 STATus:QUEStionable[:EVENT]? QUERY****STAT:QUES?**

Syntax: Short Form: STAT:QUES[EVEN]? Long Form: STATus:QUEStionable[EVENT]?  
**Return Value:** <int\_value> actual register value

Description: **Indicates the latched condition of the Questionable Event register.** Returns the value of the Questionable Event register (see Table B-5). The Questionable Event register is a read-only register which holds (latches) all events. Only bits 13 and 12 are latched in the Status Questionable Event register. Bits 0 and 1 of the Status Questionable Condition Register are not latched in the power supply. Reading the Questionable Event register clears it. (See example, Figure B-16.)

**TABLE B-5. QUESTIONABLE EVENT REGISTER, QUESTIONABLE CONDITION REGISTER AND QUESTIONABLE CONDITION ENABLE REGISTER BITS**

CONDITION	NU	SINK	CE	VE	NU	SE	NU	TE	NU	CM	VM	
BIT	15	14	13	12	11 - 7	6	5-4	3	2	1	0	
VALUE	32,768	16,384	8192	4096	2048 - 128	64	32-16	8	4	2	1	

CE Current Error  
 CM Current Mode Error  
 NU Not Used  
 SE Slave Error  
 SINK Power Supply absorbing energy from load  
 TE Thermal Error  
 VE Voltage Error  
 VM Voltage Mode Error

**B.135 STATus:QUEStionable:CONDition? QUERY****STAT:QUES:COND?**

Syntax: Short Form: STAT:QUES:COND? Long Form: STATus:QUEStionable:CONDition?  
**Return Value:** <int\_value> actual register value

Description: **Returns the value of the Questionable Condition Register (see Table B-5).** The Questionable Condition Register contains unlatched real-time information about questionable conditions of the power supply. Bit set to 1 = condition (active, true); bit reset to 0 = condition (inactive, false). Bits 1 or 0 may be both be set, indicating the power supply is settling after a voltage change. (See example, Figure B-16.)

**B.136 STATus:QUEStionable:ENABle COMMAND****STAT:QUES:ENAB**

Syntax: Short Form: STAT:QUES:ENAB <int\_value> Long Form: STATus:QUEStionable:ENABle <int\_value>

Description: **Programs Questionable Condition Enable Register (see Table B-5).** The Questionable Condition Enable Register determines which conditions are allowed to set the Questionable Condition Register; it is a mask for enabling specific bits in the Questionable Event register that can cause the questionable summary bit (bit 3) of the Status Byte register to be set. The questionable summary bit is the logical OR of all the enabled bits in the Questionable Event register. Bit set to 1 = function enabled (active, true); bit reset to 0 = function disabled (inactive, false). (See example, Figure B-16.)

NOTES: 1. The power supply is assumed to be operating in constant voltage (CV) mode.  
 2. Examples below are intended only to illustrate command functions. Refer to PAR. 3.5.2 for programming techniques to optimize performance.

OUTP:ON	Sets output on.
STAT:PRES	Operation Condition and Questionable Condition registers are reset.
*CLS	Resets Enable Amplifier
STAT:QUES:ENAB 12228	Allows latching of CE and VE bits
STAT:OPER:ENAB 1280	Mask enabled for CC and CV bits.
STAT:OPER:ENAB?	Returns 1280 (256 + 1024) (CC and CV bits set).
INIT:CONT ON	Continuous triggers enabled.
STAT:OPER:COND?	Power supply returns 256 to indicate that power supply is in constant voltage mode.
FUNC:MODE:CURR	Commands power supply to current mode.
STAT:OPER?	Returns 1024, indicating that since the last reading of the Operation Event Register the power supply has entered Constant Current mode.
STAT:OPER?	Returns 0 indicating no changes since previous reading of the Operation Event register.
STAT:QUES?	Returns 0 (no questionable conditions occurred since previous reading
	--- OVERCURRENT CONDITION OCCURS
SYST:ERR?	Power supply returns 0, "No error" message.
*RST::VOLT 5;CURR 1;OUTP ON	The BOP is in Voltage mode and delivering 5 Volts
*ESR?	Bop returns a 0 - all functions are normal
FUNC:MODE CURR	BOP is in Current mode
*ESR?;STAT:QUES:COND?	BOP returns 8;4097 - Current error.
*ESR?;STAT:QUES?	BOP returns 0;4096 - no new errors, Current Error
*ESR?;STAT:QUES?	BOP returns 0;0 - no new errors
MEAS:CURR?;VOLT?	BOP returns 1.0E-4;5.00003E0 - Voltage is 5 volts
STAT:QUES:COND?	BOP returns 4097 - error still in effect
	Short is applied to the BOP
*ESR?;STAT:QUES:COND?	BOP returns 0;1 - Current mode is selected
MEAS:VOLT?;CURR?	BOP returns 1E-4;1.00003E0 - Current is 1 amperes
FUNC:MODE VOLT;*ESR?	BOP switches mode, returns 3 - settling
*ESR?;STAT:QUES?	BOP returns 8;8194
	Short is removed from the BOP output
STAT:QUES:COND?	BOP returns 2, voltage mode operation OK.

FIGURE B-16. USING STATUS COMMANDS AND QUERIES

**B.137 STATus:QUESTIONable:ENABLE? QUERY**

**STAT:QUES:ENAB?**

Syntax: Short Form: STAT:QUES:ENAB? Long Form: STATus:QUESionable:ENABLE?  
 Return Value: <int\_value> actual register value

Description: **Reads Questionable Condition Enable Register (see Table B-5).** Power supply returns value of Questionable Condition Enable Register, indicating which conditions are being monitored. Bit set to 1 = function enabled (active, true); bit reset to 0 = function disabled (inactive, false). **Related Commands:** STAT:QUES?. (See example, Figure B-16.)

**B.138 SYSTem:BEEP COMMAND**

**SYST:BEEP**

Syntax: Short Form: SYST:BEEP Long Form: SYSTem:BEEP

Description: Causes the unit to emit a brief audible tone



### B.139 SYSTem:COMMunication:GPIB:ADDRess COMMAND **SYST:COMM:GPIB:ADDR**

#### [MG MODELS ONLY]

Syntax: Short Form: SYST:COMM:GPIB:ADDR<INT VAL> 0 to 30  
Long Form: SYSTem:COMMunication:GPIB:ADDRess<INT VAL> 0 to 30

Description: **Sets selected power supply GPIB address.** NOTE: After executing this command, subsequent commands must be directed to the new GPIB address. Requires MEM:UPD (PAR. B.20) to save for power up. See PAR. 3.5.2.2 and Figure 3-17 for special programming considerations.

### B.140 SYSTem:COMMunication:GPIB:ADDRess? QUERY **SYST:COMM:GPIB:ADDR?**

#### [MG MODELS ONLY]

Syntax: Short Form: SYST:COMM:GPIB:ADDR?  
Long Form: SYSTem:COMMunication:GPIB:ADDRess?  
Return Value: <int\_value> 0 to 30

Description: **Identifies selected power supply GPIB address.**

### B.141 SYSTem:COMMunication:LAN:AUTO COMMAND **SYST:COMM:LAN:AUTO**

#### [ME MODELS ONLY]

Syntax: Short Form: SYST:COMM:LAN:AUTO {ON | OFF}  
Long Form: SYSTem:COMMunication:LAN:AUTO {ON | OFF}

Description: **Specifies the AUTO MODE.** When set to OFF, the static addresses set by the user from the front panel or using SYST:COMM:LAN commands are used for LAN communication. When set to ON, the unit obtains a valid IP address automatically.

### B.142 SYSTem:COMMunication:LAN:AUTO? QUERY **SYST:COMM:LAN:AUTO?**

#### [ME MODELS ONLY]

Syntax: Short Form: SYST:COMM:LAN:AUTO? Long Form: SYSTem:COMMunication:LAN:AUTO?  
Return Value: {ON | OFF}

Description: Indicates whether AUTO IP is set to ON or OFF.

### B.143 SYSTem:COMMunication:LAN:DHCP COMMAND **SYST:COMM:LAN:DHCP**

#### [ME MODELS ONLY]

Syntax: Short Form: SYST:COMM:LAN:DHCP {ON | OFF}  
Long Form: SYSTem:COMMunication:LAN:DHCP {ON | OFF}

Description: **Specifies the DHCP MODE.** When set to OFF, the static addresses set by the user from the front panel or using SYST:COMM:LAN commands are used for LAN communication. When set to ON, the unit queries the DHCP server for a valid IP address.

### B.144 SYSTem:COMMunication:LAN:DHCP? QUERY **SYST:COMM:LAN:DHCP?**

#### [ME MODELS ONLY]

Syntax: Short Form: SYST:COMM:LAN:DHCP? Long Form: SYSTem:COMMunication:LAN:DHCP?  
Return Value: {ON | OFF}

Description: **Indicates whether DHCP is set to ON or OFF.**

### B.145 SYSTem:COMMunication:LAN:IP COMMAND **SYST:COMM:LAN:IP**

#### [ME MODELS ONLY]

Syntax: Short Form: SYST:COMM:LAN:IP {w,x,y,z}  
Long Form: SYSTem:COMMunication:LAN:IP {w,x,y,z}  
where w, x, y, and z are numbers from 0 to 255

Description: **Specifies the IP address when DHCP (see PAR. B.143) is set to OFF.** (Note that IP address must be comma-separated.)

### B.146 SYSTem:COMMunication:LAN:IP? QUERY **SYST:COMM:LAN:IP?**

#### [ME MODELS ONLY]

Syntax: Short Form: SYST:COMM:LAN:IP? Long Form: SYSTem:COMMunication:LAN:IP?  
Return Value: <int\_value> {w,x,y,z}  
where w, x, y, and z are numbers from 0 to 255

Description: **Indicates the static IP address (comma separated).**

**B.147 SYSTem:COMMunication:LAN:MAC? QUERY**

**SYST:COMM:LAN:MAC?**

**[ME MODELS ONLY]**

Syntax: Short Form: SYST:COMM:LAN:MAC? Long Form: SYSTem:COMMunication:LAN:MAC?

Return Value: xx,xx,xx,xx where xx = hex character pairs

Description: **Return the MAC address of the unit.** For example, MAC address of 01-23-45-67-89-AB returns 01,23,45,67,89,AB. NOTE: If 00 is returned, the LAN interface is not installed.

**B.148 SYSTem:COMMunication:LAN:MASK COMMAND**

**SYST:COMM:LAN:MASK**

**[ME MODELS ONLY]**

Syntax: Short Form: SYST:COMM:LAN:MASK {w,x,y,z}

Long Form: SYSTem:COMMunication:LAN:MASK {w,x,y,z}

where w, x, y, and z are numbers from 0 to 255

Description: **Specifies the MASK address when DHCP (see PAR. B.143) is set to OFF.** (Note that MASK address must be comma-separated.)

**B.149 SYSTem:COMMunication:LAN:MASK? QUERY**

**SYST:COMM:LAN:MASK?**

**[ME MODELS ONLY]**

Syntax: Short Form: SYST:COMM:LAN:MASK? Long Form: SYSTem:COMMunication:LAN:MASK?

Return Value: <int\_value> {w,x,y,z}

where w, x, y, and z are numbers from 0 to 255

Description: **Indicates the static MASK address (comma separated).** For example, mask of 255.255.255.0 returns 255,255,255,0.

**B.150 SYSTem:COMMunication:LAN:LRST COMMAND**

**SYST:COMM:LAN:LRST**

**[ME MODELS ONLY]**

Syntax: Short Form: SYST:COMM:LAN:LRST Long Form: SYSTem:COMMunication:LAN:LRST

Description: **Resets the LAN settings to the defaults.** Default settings are:  
DHCP to ON,  
AUTO IP to ON,  
NAME to BOP\_V\_A, where V = rated voltage of unit (Volts), and A = rated current of unit (Amperes)  
INDEX set to an unused number between 1 and 99 and appended to the numeric portion of the serial number

**B.151 SYSTem:COMMunication:SERial:BAUD COMMAND**

**SYST:COMM:SER:BAUD**

Syntax: Short Form: SYST:COMM:SER:BAUD {19200 | 9600 | 4800 | 2400}

Long Form: SYSTem:COMMunication:SERial:BAUD {19200 | 9600 | 4800 | 2400}

Description: **Sets the unit to operate at the specified baud rate.** See PAR. 3.5.2.2 and Figure 3-17 for special programming considerations.

**B.152 SYSTem:COMMunication:SERial:BAUD? QUERY**

**SYST:COMM:SER:BAUD?**

Syntax: Short Form: SYST:COMM:SER:BAUD?

Long Form: SYSTem:COMMunication:SERial:BAUD?

Return Value: <int\_value> {19200 | 9600 | 4800 | 2400}

Description: **Returns operating baud rate.**

**B.153 SYSTem:COMMunication:SERial:ECHO COMMAND**

**SYST:COMM:SER:ECHO**

Syntax: Short Form: SYST:COMM:SER:ECHO {ON | OFF} or {01 | 00}

Long Form: SYSTem:COMMunication:SERial:ECHO {ON | OFF} or {01 | 00}

Description: **Enables (ON) or disables (OFF) echo mode** (see PAR. 3.5.6.2.2). Sending ON or 01 causes all subsequent characters to be echoed back. Sending OFF or 00 turns off the character echo after the next line terminator character. The \*RST command has no effect on echo status. See PAR. 3.5.2.2 and Figure 3-17 for special programming considerations.

**B.154 SYSTem:COMMunication:SERial:ECHO? QUERY      SYST:COMM:SER:ECHO?**

Syntax:      Short Form: SYST:COMM:SER:ECHO?  
Long Form: SYSTem:COMMunication:SERial:ECHO?  
Return Value: {01 | 00}

Description: **Returns 01 when echo mode is active (ON) or 00 when disabled (OFF)** (see PAR. 3.5.6.2.2).

**B.155 SYSTem:COMMunication:SERial:PACE COMMAND      SYST:COMM:SER:PACE**

Syntax:      Short Form: SYST:COMM:SER:PACE {NONE | XON}  
Long Form: SYSTem:COMMunication:SERial:PACE {NONE | XON}

Description: **Enables (XON) or disables (NONE) data flow control via the serial interface** (see PAR. 3.5.6.2.1).  
See PAR. 3.5.3.3 and Figure 3-17 for special programming considerations.

**B.156 SYSTem:COMMunication:SERial:PACE? QUERY      SYST:COMM:SER:PACE?**

Syntax:      Short Form: SYST:COMM:SER:PACE?  
Long Form: SYSTem:COMMunication:SERial:PACE?  
Return Value: {01 | 00}

Description: **Returns 01 when data flow control via the serial interface is enabled (XON) or 00 when disabled (NONE)** (see PAR. 3.5.6.2.1).

**B.157 SYSTem:COMMunication:SERial:PROMpt COMMAND      SYST:COMM:SER:PROM**

Syntax:      Short Form: SYST:COMM:SER:PROM {ON | OFF} or {0 | 1}  
Long Form: SYSTem:COMMunication:SERial:PROMpt {ON | OFF} or {0 | 1}

Description: **Enables (1 or ON) or disables (0 or OFF) prompt** (see PAR. 3.5.6.2.3). Sending 1 or ON causes the unit to return > character after the command is parsed. See PAR. 3.5.2.2 and Figure 3-17 for special programming considerations.

**B.158 SYSTem:COMMunication:SERial:PROMpt? QUERY      SYST:COMM:SER:PROM?**

Syntax:      Short Form: SYST:COMM:SER:PROM?  
Long Form: SYSTem:COMMunication:SERial:PROMpt?  
Return Value: {1 | 0}

Description: **Returns 1 when prompt is enabled (ON) or 0 when disabled (OFF)**. (See PAR. 3.5.6.2.3.)

**B.159 SYSTem:ERRor? QUERY      SYST:ERR?**

Syntax:      Short Form: SYST:ERR?      Long Form: SYSTem:ERRor?  
**Return Value:** <int\_value,string>

Description: **Posts error messages to the output queue.** Returns the next error number followed by its corresponding error message string from the instrument error queue. The error queue is a FIFO (first in first out) buffer that stores errors as they occur. As it is read, each error is removed from the queue and the next error message is made available. When all errors have been read, the query returns 0,"No error". If more errors are accumulated than the queue can hold, it will overflow. The oldest errors stay in the queue but the most recent errors are discarded. The last error in the queue will be -350,"Queue Overflow." Error messages are defined in Table B-6.

**B.160 SYSTem:ERRor:CODE? QUERY      SYST:ERR:CODE?**

Syntax:      Short Form: SYST:ERR:CODE?      Long Form: SYSTem:ERRor:CODE?

Description: **Returns the three character error code without the ASCII definition string.** The error codes are defined in table B-6 (See example, Figure B-18.)

**B.161 SYSTem:ERRor:CODE:ALL? QUERY****SYST:ERR:CODE:ALL?**

Syntax: Short Form: SYST:ERR:CODE:ALL? Long Form: SYSTem:ERRor:CODE:ALL?  
Return Value:

Description: **Returns a comma-separated list of all error codes.** A maximum of 31 codes will be returned; if the queue is empty, the power supply returns 0.

**B.162 SYSTem:KEYBoard COMMAND****SYST:KEYB**

Syntax: Short Form: SYST:KEYB [DIS | ENAB] Long Form: SYSTem:KEYBoard [DISable | ENABLE]

Description: **Locks (DIS) or unlocks (ENAB) the front panel keypad.**

**B.163 SYSTem:KEYBoard? QUERY****SYST:KEYB?**

Syntax: Short Form: SYST:KEYB? Long Form: SYSTem:KEYBoard?  
Returns: 1 or 0

Description: **Identifies the state of the keypad: locked (1) or unlocked (0).**

**B.164 SYSTem:MDNS? QUERY****SYST:MDNS?****[ME MODELS ONLY]**

Syntax: Short Form: SYST:MDNS? Long Form: SYSTem:MDNS?  
Returns: <hostname> where <hostname> = a string comprised of the MDNS Name + unit serial number + index number

Description: **Returns MDNS hostname.** Index number is not appended to the serial number if the index is 1.

Example: SYST:MDNS? returns BOP\_10\_100\_E12345602 for a BOP 10-100ME with a serial number of E123456 and an index of 2. Returns BOP\_10\_100\_E1234560 if index is 1.

**B.165 SYSTem:MDNS:INDex COMMAND****SYST:MDNS:IND****[ME MODELS ONLY]**

Syntax: Short Form: SYST:MDNS:IND nn Long Form: SYSTem:MDNS:INDex<hostname>  
where nn = integer between 1 and 99.

Description: **Sets the index number portion of the MDNS Hostname.** Index number (1 through 99) is automatically assigned: 1 for first unit found, subsequent identical units are assigned sequential index numbers to make the Host Name and Index a unique identifier. May be changed to an unused number between 1 and 99 if desired.

**B.166 SYSTem:MDNS:IND? QUERY****SYST:MDNS:IND?****[ME MODELS ONLY]**

Syntax: Short Form: SYST:MDNS:IND? Long Form: SYSTem:MDNS:INDex?  
Returns: integer from 1 to 99

Description: **Returns MDNS index number.**

**B.167 SYSTem:MDNS:NAME COMMAND****SYST:MDNS:NAME****[ME MODELS ONLY]**

Syntax: Short Form: SYST:MDNS:NAME <hostname> Long Form: SYSTem:MDNS:NAME <hostname>  
where <hostname> = up to 12 ASCII characters

Description: **Sets the 12 character MDNS Hostname field.** Default host name is model\_V\_A (e.g., BOP\_10\_100 for BOP 10-100ME). Host Name can be changed as the user desires. Up to 12 ASCII characters are permitted.

**B.168 SYSTem:MDNS:NAME? QUERY****SYST:MDNS:NAME?****[ME MODELS ONLY]**

Syntax: Short Form: SYST:MDNS:NAME? Long Form: SYSTem:MDNS:NAME?  
Returns: string up to 12 ASCII characters

Description: **Returns MDNS host name.** May be up to 12 ASCII characters.

### B.169 SYSTem:MODE COMMAND

## SYST:MODE

Syntax: Short Form: SYST:MODE {BIP | UNIP}  
Long Form: SYSTem:MODE {BIPolar | UNIPolar}

Description: **Used to set mode to Bipolar (default) or Unipolar.** Set to BIPolar to allow the unit to meet the 60 millisecond (maximum) specification between setpoint change and measurement response.

NOTE: When set to BIPolar, changing of the voltage setpoint in voltage mode **requires** using VOLT:MODE command to set voltage and CURR:PROT to set the current limit. Changing of the current setpoint in current mode **requires** using CURR:MODE command to set current and VOLT:PROT to set the voltage limit. When set to BIPolar no drivers are available.

When set to UNIPolar the unit still synchronizes setpoint changes with measurements, but the 60 milliseconds (maximum) specification is not attainable. When set to UNIPolar the unit functions with the drivers described in the manual.

### B.170 SYSTem:MODE? QUERY

## SYST:MODE?

Syntax: Short Form: SYST:MODE? Long Form: SYSTem:MODE?  
Return Value: BIP = Bipolar, UNIP = Unipolar

Description: **Returns BIP or UNIP to indicate whether the mode is set to Bipolar or Unipolar, respectively).**

### B.171 SYSTem:PASSword:CENable COMMAND

## SYST:PASS:CEN

Syntax: Short Form: SYST:PASS:CEN <val>  
Long Form: SYSTem:PASSword:CENable <val>

Description: **Sets the password enable state if the value matches the current Main password.** This command allows CALibrate commands to operate.

### B.172 SYSTem:PASSword:CDISable COMMAND

## SYST:PASS:CDIS

Syntax: Short Form: SYST:PASS:CDIS Long Form: SYSTem:PASSword:CDISable

Description: **Clears the password enable state.**

### B.173 SYSTem:PASSword:NEW COMMAND

## SYST:PASS:NEW

Syntax: Short Form: SYST:PASS:NEW <old password>,<new password>  
Long Form: SYSTem:PASSword:NEW <old password>,<new password>

Description: **Establishes new password.** The old (current) Main password is checked, then replaced by the new password. Admin 1 and 2 passwords (PAR. 3.2.4.2) are not available. Lower case characters are automatically converted to uppercase unless included in double quotes. however lower case passwords can not be entered from the front panel. (See example, Figure B-18.) See PAR. 3.5.2.2 and Figure 3-17 for special programming considerations.

### B.174 SYSTem:PASSword:STATe? QUERY

## SYST:PASS:STAT?

Syntax: Short Form: SYST:PASS:STAT? Long Form: SYSTem:PASSword:STATe?  
Return Value: <int\_value> 0 or 1

Description: Returns a 1 if the password state is enabled or a 0 if it is disabled.

### B.175 SYSTem:REMOte COMMAND

## SYST:REM

Syntax: Short Form: SYST:REM {ON | OFF} or {1 | 0}  
Long Form: SYSTem:REMOte {ON | OFF} or {1 | 0}

Description: **Used during serial (RS 232) communication to set the unit to remote (1 or ON) or local (0 or OFF) mode.** This command must be issued prior to commands that affect the power supply output (e.g., VOLT 10;:OUTP ON) to ensure the unit is in remote mode. See PAR. 3.5.6.3 and Figure B-17.

### B.176 SYSTem:REMOte? QUERY

## SYST:REM?

Syntax: Short Form: SYST:REM? Long Form: SYSTem:REMOte?  
Return Value: {1 | 0}

Description: **Identifies whether unit is in remote mode (1) or local mode (0) during serial (RS 232) communication.** See PAR. 3.5.6.3 and Figure B-17.

*IDN?	Unit responds with KEPCO,BOP 50-20,E1234,1.66 (typical).
OUTP?	Unit responds with 0 indicating output is off
SYST:REM?	Unit responds with 0 indicating unit is in local mode.
SYST:REM 1	Puts unit in remote mode.
OUTP ON	Enables output
OUTP?	Unit responds with 1 (output on).
SYST:REM 0	Unit set to local mode.

**FIGURE B-17. SETTING THE UNIT TO REMOTE MODE VIA SERIAL (RS 232) PORT**

### B.177 SYSTem:SECurity:IMMEDIATE COMMAND

## SYST:SEC:IMM

Syntax: Short Form: SYST:SEC:IMM Long Form: SYSTem:SECurity:IMMEDIATE

Description: **Initializes all NVRAM variables to factory defaults.** Empties all memory locations. See PAR. 3.5.2.2 and Figure 3-17 for special programming considerations. This command is password protected (must be preceded by SYST:PASS:CEN (see PAR B.171).

### B.178 SYSTem:SET COMMAND

## SYST:SET

Syntax: Short Form: SYSTem:SET {CM0 | CM1 | DCL0 | DCL1 | LF0 | LF1 | RO0 | RO1}  
Long Form: SYSTem:SET {CM0 | CM1 | DCL0 | DCL1 | LF0 | LF1 | RO0 | RO1}

Description: **Establishes Device Clear, Line Feed, OUTP command and Reset functions. Sending SYST:SEC:IMM sets LF1, DC0, and RO0 (as if CM0 was sent).** Requires MEM:UPD (PAR. B.20) to save for power up. See PAR. 3.5.2.2 and Figure 3-17 for special programming considerations.

DCL0	Device Clear functions per IEEE 488.2 Standard. (No effect on the device (power supply), only clears internal status registers.)
DCL1	Device Clear functions identical to *RST (Output set to 0V, voltage mode and output set to OFF except if RO1 (see below) is set.)
LF0	Line Feed not provided upon empty buffer condition
LF1	Line Feed provided if buffer is empty and a read is performed.
RO0	*RST and power up set output to OFF, 0V, 0A, voltage mode.
RO1	*RST sets output to ON, 0V, 0A, voltage mode. Subsequent VOLT and CURR commands are immediately present at the output without sending OUTP ON (OUTP OFF and OUTP ON function normally to turn the output off or on.)
CM0	Establishes DCL0, LF0, RO0 conditions described above. (SCPI 1997 Standard compliance)
CM1	Establishes DCL1, LF1, RO1 conditions described above. (Compatible with software versions 1.2 and earlier) (See example, Figure B-18.)

### B.179 SYSTem:SET? QUERY

## SYST:SET?

Syntax: Short Form: SYST:SET? Long Form: SYSTem:SET?  
Return Value: DCL<n>,LF<n>,RO<n> where n = 0 or 1

Description: **Identifies functions established by SYST:SET command.** (See example, Figure B-18.)

### B.180 SYSTem:VERSion? QUERY

## SYST:VERS?

Syntax: Short Form: SYST:VERS? Long Form: SYSTem:VERSion?  
Return Value: <int\_value>.<int\_value> (YYYY.V)

Description: **Identifies SCPI Version implemented.** Returns SCPI Version number

:

YYYY = year, V = Revision number for specified year. (See example, Figure B-18.)

SYST:VERS?	Unit returns 1997
SYST:SET?	Unit returns DC0,LF0,RL0,OUT0
SYST:PASS:NEW DEFAULT,OKAY	Unit changes password to be OKAY
SYST:SET LF1,RL1,DC1	Configures Device Clear, Line Feed and Reset (see PAR. B.178).
SYST:PASS:CEN OKAY	Password enabled commands are accepted
MEM:UPDATE INTERFACE	Unit saves the LF1 state for next power on cycle.

**FIGURE B-18. USING SYSTEM COMMANDS AND QUERIES**

**B.181 TRIGger:SOURce COMMAND**

**TRIG:SOUR**

Syntax: Short Form: TRIG:SOUR {BUS | EXT | IMM}  
 Long Form: TRIGger:SOURce {BUS | EXT | IMM}

Description: **Selects the active trigger source.** When TRIG:SOUR BUS is set, an event trigger is created by sending either \*TRG or GPIB <GET> commands. When TRIG:SOUR EXT is set, the trigger is created by connecting the external trigger line (J2, pin 4 or pin 3 of the mating connector for J2) to analog signal ground (J2, pin 1 or J2 mating connector, pin 1). The trigger must be armed by sending either INIT:IMM or INIT:CONT enable (ON) commands prior to sending the selected trigger command. (see PAR. A.16). Receipt of the active trigger causes the power supply to program to the previously stored values of VOLT:TRIG and CURR:TRIG (actual output voltage/current is dependent upon the load). Sending TRIG:SOUR IMM causes the next VOLT:TRIG or CURR:TRIG to immediately program the output, regardless of trigger arming. \*RST sets TRIG:SOUR to BUS. Related Commands: <GET>, \*TRG, INIT:IMM, INIT:CONT.

**B.182 TRIGger:SOURce? QUERY**

**TRIG:SOUR?**

Syntax: Short Form: TRIG:SOUR? Long Form: TRIGger:SOURce?  
 Returns: BUS, IMMEDIATE or EXTERNAL

Description: **Identifies whether internal, immediate or external trigger is activated.**

**TABLE B-6. ERROR MESSAGES**

ERROR MESSAGE	ESR ERROR BIT SET (SEE PAR. A.5)	EXPLANATION
0,"No error"	None	No error
1,"Interprocessor communications error"	Device Error bit 3 <sup>(1)</sup>	Interprocessor communications error
2,"Configuration error"	Device Error bit 3 <sup>(1)</sup>	Configuration error
10,"Program Error"	Device Error bit 3 <sup>(1)</sup>	Program error
1xx01,"A2 Temperature Error" 1xx02,"A3 Temperature Error" 1xx03,"Output Overcurrent" 1xx04,"Output Overvoltage" 1xx05,"A2 Instant Overcurrent" 1xx06,"A2 (+)15V BUS Missing" 1xx07,"A4 Missing -15V Supply Voltage (@A4A3D84)" 1xx08,"A4 Module Temperature Error (@A4A3D8)" 1xx09,"Input Module Error (@A4A3D20)" 1xx10,"A2 Output Module Error (@A4A3D6" 1xx11,"A4 Primary Section Error (@A4A3D10)" 1xx12,"A2 Input Over Current (@A4A3D7)"	Device Error bit 3 <sup>(1)</sup>	Indicates the power supply or one of the connected power supplies has detected an error. These errors are an indication of a hardware problem in the BOP. The last two digits of the error code indicate the type of error and its source; xx indicates the position of the unit on the BITBUS: xx = 1: Device 1
(1)	The Device error bit may be set when the status monitoring functions of the power supply detect an overvoltage/under-voltage condition.	

**TABLE B-6. ERROR MESSAGES (CONTINUED)**

ERROR MESSAGE	ESR ERROR BIT SET (SEE PAR. A.5)	EXPLANATION
2yy01,"OVER TEMPERATURE" 2yy02,"CROWBAR ACTIVE" 2yy03,"DEVICE TURNED OFF" 2yy04,"CURRENT FAULT" 2yy05,"POWER LOSS" 2yy06,"VOLTAGE FAULT" 2yy07,"RELAY OPEN", 2yy08,"POLARITY ERROR" 2yy09,"OVERLOAD"	Device Error bit 3 <sup>(1)</sup>	Indicates a hardware problem has been detected in either the BOP power supply or an auxiliary power supply, such as Kepco's MST, MAT, MBT or low power (under 1KW) BOP, connected to the BITBUS. The last two digits of the error code indicate the type of error detected,; yy indicates the position of the unit on the BITBUS yy = 2: Device 2 through yy = 15: Device 15
-100,"Command error"	Command Error bit 5	Command and data understood, but more information included which is not recognized.
-120,"Numeric data error"	Command Error bit 5	Expected number but other characters were detected
-123 "Exponent too Large;E8"	Command Error bit 5	Exponent too large.
-203,"Command Protected"	Execution error bit 4	Password must be CENabled
-221,"Settings Conflict; Output Off"	Execution error bit 4	Output Off
-221,"Settings Conflict; External Reference in use"	Execution error bit 4	External Reference in use.
-221,"Settings Conflict; Mode incorrect"	Execution error bit 4	Mode incorrect.
-221,"Settings Conflict; List running"	Execution error bit 4	List running.
-222,"Current, Voltage or Data out of range"	Execution error bit 4	Value (current or voltage) exceeds power supply rating or (data) exceeds acceptable command parameters.
-222,"Data out of range; Voltage"	Execution error bit 4	Voltage value exceeds power supply rating
-222,"Data out of range; Current"	Execution error bit 4	Current value exceeds power supply rating
-222,"Data out of range; Dwell"	Execution error bit 4	Data out of range; Dwell
-223,"Too Much Data"	Execution error bit 4	During a LIST command, the list became full, preventing all the data from being added to the list.
-224,"Illegal parameter value"	Execution error bit 4	Parameter value illegal.
-226,"Lists not same length"	Execution error bit 4	During a LIST command, number of DWEL list entries was not equal to 1 and did not match number of LIST:VOLT or LIST:CURR entries.
-226,"Lists not same length; Too small"	Execution error bit 4	During a LIST command, number of DWEL list entries was not equal to 1 and did not match number of LIST:VOLT or LIST:CURR entries.
-240,"Hardware error"	Execution error bit 4	Power supply did not respond to command.
-241,"Hardware missing; External Reference not supported"	Execution error bit 4	External Reference not supported.
-241,"Hardware missing; Bipolar limits not supported"	Execution error bit 4	Bipolar limits not supported.
-242,"Voltage comparison error"	Execution error bit 4	Issued during Voltage calibration (Volt [zero, max, min], voltage external protect, Voltage in series) indicating the measurements are incorrect.
-243, "Current comparison error"	Execution error bit 4	Issued during Current Calibration (Current (max, min or Zero, Current external limit, slave input) indicating the measurements are incorrect.
(1)	The Device error bit may be set when the status monitoring functions of the power supply detect an overvoltage/under-voltage condition.	



**TABLE B-6. ERROR MESSAGES (CONTINUED)**

ERROR MESSAGE	ESR ERROR BIT SET (SEE PAR. A.5)	EXPLANATION
<b>-311,"Memory Error"</b>	Device Error bit 3 <sup>(1)</sup>	*SAV (save), *RCL (recall), MEMory:SAVE, MEMory:UPDAte or CALibrate:STORe error
<b>-314,"Save/recall Memory Lost"</b>	Device Error bit 3 <sup>(1)</sup>	A memory location that was saved earlier was lost due to a flash error in Analog processor memory.
<b>-340,"Calibration Failed"</b>	Device Error bit 3 <sup>(1)</sup>	The calibration results were invalid. This normally indicates an incorrect calibration caused by operator error such as performing a current calibration without a load,8 or a voltage calibration with a load.
<b>-350,"Queue Overflow"</b>	Device Error bit 3 <sup>(1)</sup>	Error queue was full, error events have been lost.
<b>-363,"Input buffer overrun"</b>	Device Error bit 3 <sup>(1)</sup>	The input from the controlling computer was longer than 253 characters in length.
<b>-370,"A2 External Error"</b>	Device Error bit 3 <sup>(1)</sup>	Either external input error (A2A5 optocoupler) or an A2 error occurred that could not be defined by evaluating PAL latches.
<b>-400,"QueryError"</b>	Query Error bit 2	Data requested was lost due to 253 character limit or BIT 4886 output buffer
<b>-420,"Query Unterminated"</b>	Query Error bit 2	Controller sent query but did not accept data from power supply. See VOLT? (PAR. B.104), CAL:SAVE (PAR. B.104) commands
<b>-440,"Missing Query"</b>	Query Error bit 2	Controller sent MEM:PACK, MEM:UPD, SYST:SEC:IMM or SYST:SEC:OVER without preceding command with query or following the command with ;*OPC? (see PAR. 3.5.2.2 for details.)
(1) The Device error bit may be set when the status monitoring functions of the power supply detect an overvoltage/under-voltage condition.		



Once the power supply is installed (see full Technical Manual), this guide is an aid that briefly outlines a simple approach to accomplishing common tasks, with the appropriate Technical Manual paragraph references for more details. All instructions start from the power-up screen (press **F5** from most submenus to return to power-up screen). Many setup functions can be password protected - see UTILITY below for instructions.

## UTILITY

**How do I access a password-protected menu?** Enter first character of password using **ADJUST** control or keypad (use multiple presses of the keys for letters or symbols: **0** (space), **+**, **-**, **/**, **2** (ABC), **3** (DEF), **4** (GHI), **5** (JKL), **6** (MNO), **7** (PQRS), **8** (TUV), **9** (WXYZ). **→** to enter next character, **F1** to verify. If incorrect, press **CLEAR** and repeat (see PAR. 3.2.4.3).

**How do I use the keypad?** **STANDBY** sets output on/off (STANDBY indicator lit when output off), **MODE** selects voltage mode or current mode, arrow keys highlight selections, numbers enter values and multiple presses can enter alphanumeric characters, **+/-** sets sign, **CLEAR** sets numeric values to zero, clears alphanumerics, **RESET** is equivalent to power-up cycle, **ENTER** applies settings to output and saves changes, **HELP** is context sensitive, keep pressing for more, **F1** through **F5** functions are defined by graphic box to the left (see PAR. 3.2.1).

**How do I use the ADJUST control?** Adjusts value of highlighted digit, fine adjustment (least significant digit) if held in while adjusting. If output is on, directly controls output (pressing **ENTER** not required). Scrolls through all alphanumeric characters for password.

**How do I turn the beep on or off?** **F3**, highlight Key Press Beep, **F1**, highlight On, Error only or Off, then **F4**. **F5** to exit or **F4** to save for power-up (see PAR. 3.3.1.1).

**How do I set the display background?** **F3**, highlight Display Background, **F1**, highlight desired color, then **F4**. **F5** to exit or **F4** to save for power-up (see PAR. 3.2.5.1). If **F4** not available, see NOTE to PAR. 3.2.5).

**How do I adjust the Display contrast?** **F3**, then number key (0 = darkest, 9 = lightest). **←** or **→** for fine adjustment. **F5** to exit or **F4** to save for power-up (see PAR. 3.2.5.2). If **F4** not available, see NOTE to PAR. 3.2.5).

**How do I choose between graphical meters or time line graphs?** **F3**, Highlight Graphic Display, **F1**, highlight Meters or the appropriate Graph time, then **F4**. **F5** to exit or **F4** to save for power-up (see PAR. 3.2.5.1).

## CONTROLLING THE OUTPUT USING THE FRONT PANEL (LOCAL)

**How do I apply a voltage or current to the load?** If output is on (STANDBY indicator not lit) press **STANDBY** to turn output off (STANDBY indicator lit). Use **MODE** to select Voltage or Current mode, use **↑** or **↓** to highlight main channel, use **ADJUST** or keypad to set value, then press **ENTER**. Highlight protect channel(s) and use **ADJUST** or keypad to set value. then press **ENTER**. Press **STANDBY** to turn output on and apply programmed settings to load (see PAR. 3.3.3).

**How do I change between a single value or two different values for positive and negative protection limit?** **F3**, highlight Protect Entry, **F1**, highlight Bipolar or Independent, then **F4**. **F5** to exit or **F3** to abort or **F4** to save for power-up (see PAR. 3.3.3.1).

**How can I prevent voltage (in voltage mode) or current (in current mode) from being set beyond a predetermined level?** **F5**, highlight Max/Min Settings, **F1**. Highlight +Voltage Max, -Voltage Min, +Current Max or -Current Min as desired, **F1**, use keypad to change value, then **F4**. **F5** to exit or **F4** to save for power-up (see PAR. 3.3.4).

**How do I prevent protection limit from being set beyond a predetermined level?** **F5**, highlight Max/Min Settings, **F1**, Highlight +C Protect Max, -C Protect Min, +V Protect Max or -V Protect Min as desired, **F1**, use keypad to change value, then **F4**. **F5** to exit, **F3** to abort or **F4** to save for power-up (see PAR. 3.3.4.2).

**What happens when the protect setting is reached?** Limit channel controls power supply, display shows the message CPROTECT (current protection in voltage mode) VPROTECT (voltage protection in current mode) or PROTECT (external analog protection).

## POWER SUPPLY SETUP

**How do I configure for resistive, active or battery type load?** **F5**, highlight Load Type, **F1**, **F1**, highlight Active, Resistive, or Battery then **F4**. Press **F5** to exit, **F3** to abort or **F4** to save for power-up (see PAR. 3.3.7).

**How do I control whether the output is on or off upon \*RST?** **F5**, **F1**, highlight \*RST sets Output, **F1**, highlight On or Off, then **F4**. Press **F5** to exit or **F4** to save for power-up (see PAR. 3.5.3.1).

**How do I control what condition the unit is in upon power up.** **F5**, highlight Power Up Settings, **F1**, highlight parameter, **F1**, highlight desired power-up state, then **F4**. Repeat for all parameters, then **F5** to exit or **F4** to save for power-up (see PAR. 3.3.8).

## CONTROLLING THE OUTPUT USING EXTERNAL (ANALOG) SIGNALS (REMOTE)

**How do I control the mode using an external signal?** **F4**, highlight External Mode, **F1**, highlight Enable, **F4**, then **F5** to apply changes and exit or **F3** to abort. This setting is not saved for power-up (PAR. 3.4.3). Select mode by applying either logic 1 or open circuit for voltage, or logic 0 or short circuit for current, to pin 2 referenced to pin 9 of the Analog I/O port (PAR. 3.4.3).

**How do I use an analog voltage to control the output (main channel)?** **F4**, highlight Reference input, **F1**, highlight External then **F4**, then **F5** to apply changes and exit. This setting is not saved for power-up. Apply ±10V signal to pin 11 referenced to pin 4 of the Analog I/O port to control active channel (voltage or current) (PAR. 3.4.4.1).

**How do I use an analog voltage to control the protection channel?** **F4**, highlight Protection Limit, **F1**, highlight External then **F4**, then **F5** to apply changes and exit (not saved for power-up). Apply +1V to +10V signal to the following pins referenced to pin 12 of the Analog I/O port to control limit channel from 10% to full scale: -Current Protect: pin 5, +Current Protect: pin 13, -Voltage Protect: pin 6, +Voltage Protect: pin 14 (PAR. 3.4.5).

**How do I choose between local, digital and analog control of the output?** The unit normally powers up in Local mode. Sending a command via RS 232 or GPIB interfaces automatically puts the unit into Remote mode. Press **F1** to restore Local mode. If an analog voltage is controlling the output (see above), local control of the main channel is disabled and digital commands are not accepted.

**How do I use the BOP as an amplifier?** See above to control the main channel and/or protection channel using analog signals. The nominal (inherent) voltage gain of each model is calculated by  $(G_{NOM-V}) = E_{Onom} / E_{REF}$  and nominal (inherent) current gain is  $(G_{NOM-I}) = I_{Onom} / E_{REF}$  where  $E_{REF} = 10V$  (see PAR. 3.4.4.1).

**How do I control the gain of the BOP when used as an amplifier?** **F4**, highlight Reference input, **F1**, highlight ExtlRefLevel then **F4**, then **F5** to apply changes and exit (not saved for power-up). Apply ±10V signal to pin 11 referenced to pin 4 of the Analog I/O port. Main channel setting (SET) determines gain (G) by  $G = SET/10$  (PAR. 3.4.4.2).

## CONTROLLING THE OUTPUT USING DIGITAL INTERFACE (REMOTE)

**How do I use the GPIB interface to control the power supply (MG, MGL Models)?** **F5**, highlight Interface Settings, **F1**, highlight GPIB address, then **F1**. To change GPIB address, use keypad to enter new address then **F4**. Press **F5** to apply changes without saving for power-up (see PAR. 3.5.3.2).

**How do I use the RS 232 interface to control the power supply?** **F5**, highlight Interface Settings, **F1** to enter submenu.. To change Baud Rate: highlight Baud Rate, **F1** highlight desired selection, **F4**. To change XON/XOFF: **F1**, highlight Baud Rate, **F1**, highlight XON/XOFF, **F1** highlight desired selection, **F4**. To change Prompt: highlight Prompt, **F1**, highlight desired selection, **F4**. When complete, **F5** to apply changes and exit or **F4** to save for power-up (see PAR. 3.5.3.3).

**How do I change between SCPI and CIIIL Data Format?** **F5**, highlight Interface Settings, **F1**, highlight Language, **F1**, highlight SCPI or CIIIL then **F4**. **F5** to exit or **F4** to save for power-up. (PAR. 3.5.3.2.2)

**How do I use the LAN interface to control the power supply (ME, MEL models)?** Enter BOP IP address in web browser to open LAN interface UNIT DESCRIPTION (home) page. Click OPERATE INSTRUMENT to control the BOP. Click CONFIGURE LAN to change LAN settings. Click ID INSTRUMENT to blink BOP rear panel LAN indicator. (PAR. 3.5.7)

## FEATURES

**How do I save the power supply settings for future use?** **F1**, Use **↓**, **↑** keys to highlight **Empty** location, **F1**. The power supply settings (Mode, type and values for Main Channel Reference and Protection, and output on/off) are displayed. To save a different setting than that displayed, highlight the parameter, **F1** highlight the selection or enter value using keypad, then **F4**. **F5** to exit or **F4** to save for power-up. (PAR. 3.3.9)

**How do I modify saved power supply settings for future use?** **F1**, highlight desired location, **F1**. The power supply settings (Mode, Main Channel Reference and value, Protection type and values and output on/off) are displayed. To change a setting, highlight the parameter, **F1** highlight the selection or enter value using keypad, then **F4**. **F5** to exit or **F4** to save for power-up. (PAR. 3.3.9)

**How do I recall previously saved power supply settings?** **F1**, highlight desired location. **F2** to execute stored settings or **F1** to see details, then **F2** to program settings. (PAR. 3.3.9)

**How do I view or execute a waveform?** **F2** highlight Waveform name, **F1** to view, press **STANDBY** to turn output on, **F4** to execute. **F5** to stop waveform execution. (PAR. 3.3.10)

**How do I create a waveform?** Use arrow keys to highlight **Empty**, **F2**, **F1**. Enter name using **ADJUST** or keypad (multiple presses for letters) and **→**, then **F4**. To change Mode highlight selection, **F1**, highlight Voltage or Current, **F4** to save for power-up. To change protection, highlight setting, **F1**, enter new setting using keypad, **F4**. To change count, highlight setting, **F1**, enter new setting using keypad, **F4**. Define first segment (Type, Frequency, Amplitude (p-p) and Offset) by highlighting parameter, **F1**, highlight desired setting or use keypad to enter value, then **F4**. Highlight segment or End of Segments, **F2** to insert next segment prior to highlight or **F3** to erase segment. Define new segment or re-edit existing segment in the same way (including start/stop angle for sine or triangle), then **F4**. (PAR. 3.3.10.9) See above to execute waveform.

**How do I calibrate the unit?** **F5**, highlight Calibration, **F1**, then proceed per screen prompts.

**How do I configure unipolar operation?** Set either + or - Maximum to zero as follows: **F5**, highlight Max/Min Settings, **F1**, highlight +Voltage Max, -Voltage Min, +Current Max or -Current Min as desired, **F1**, press **CLEAR** to set to zero, then **F4**. **F5** to exit or **F4** to save for power-up (see PAR. 3.3.4).

**Can I further customize the configuration?** Yes, contact Kepco for further information.