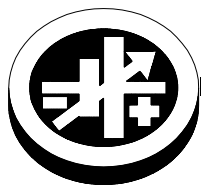


# QUICK START GUIDE



**KEPCO** An ISO 9001 Company.

**BOP  
1KW-G**



## BOP 1KW-G POWER SUPPLY

This guide gives a brief introduction to the BOP 1KW-G Power supply, shows simple load connections, and allows you to verify the power supply is working. The guide also shows you how to perform the most commonly used functions.

**ACCESSING MANUALS.** First determine your Firmware Version (see below), then download the BOP 1KW-G Operator's Manual from

[www.kepcopower.com/support/opmanls.htm#bop-g](http://www.kepcopower.com/support/opmanls.htm#bop-g)

Refer to the BOP 1KW-G Operator's Manual for full specifications, installation considerations and operating instructions. The BOP 1KW-G Operator's Manual also includes a full description of the digital interfaces and the SCPI command language.

**NOTE:** Download the latest version of this guide at:

[www.kepcopower.com/support/opmanls.htm#bop-g](http://www.kepcopower.com/support/opmanls.htm#bop-g)

**FIRMWARE VERSION.** With no load connected and power off, use either the GPIB port or RS 232 port (see page 6) to accept remote commands.

If necessary, refer to "Reset Power-up" on page 8 and Figure 5 to configure the GPIB address (default is 6) or configure the RS 232 baud rate (default is 9600).

Apply power to the unit and send \*IDN? query. The unit responds with a character string containing the following fields: <Manufacturer>,<Model Voltage-Current Calibration Date>,<Serial Number>, <Firmware Version> e.g., KEPCO, BOP1KW 20-50 09/30/2001,123456,4.01.

**ACCESSING DRIVERS.** Drivers are accessed from [www.kepcopower.com/drivers/drivers-dl3.htm](http://www.kepcopower.com/drivers/drivers-dl3.htm).

## CONTENTS

I Description	2
II Unpacking	2
III Equipment Supplied	2
IV Accessories	4
V Safety	4
VI Preliminary Operational Check	5
VII Installation	5
Input Connections.	5
Load Connections.	5
Local Sensing (Factory Default).	6
Remote Sensing Select.	6
Analog I/O Connections.	6
Trigger Connections.	6
GPIB Connections.	6
RS 232 Connections.	6
VIII Operation	8
Power-up Settings	8
Turning The Power Supply On.	8
Reset Power-up	8
Normal Power-up	9
Power Supply Basics.	9
Voltage and Current Parameters.	9
Setting Voltage or Current Mode.	9
Voltage/Current Protect Limits (Limit Channel Software Limits).	11
Software Limits.	11
Maximum/Minimum Protection Limits (Software-controlled).	11
Determining How the Unit Responds when Output is OFF (Load Type).	11
Configure Load Type.	13
Enabling/disabling Output Power.	13
IX Additional Features	13

## I — DESCRIPTION

The BOP 1KW-G Series hereafter referred to as BOP-G, are true 4-quadrant programmable voltage and current power supplies, meaning they are capable of both sourcing and sinking power (see Figure 1).

These bipolar power supplies pass smoothly through zero without switching to provide true  $\pm$  voltage and  $\pm$  current. These BOP-G power supplies use switch mode technology for low dissipation. A bi-directional, isolating, a-c input power factor correcting (PFC) circuit recuperates energy sunk from an active load and sends it back into the line to maintain low dissipation.

These BOP power supplies can be controlled remotely by an analog  $\pm 10V$  input for the main channel (voltage or current), and by a +1 to +10V input for the limit channels. They can also be controlled through one of the standard digital interfaces (GPIB or RS 232) to set voltage and current and the four protection limits (+voltage, -voltage, +current and -current.) Output current can be remotely monitored via the analog monitor signal present at the rear panel Analog I/O Port connector. Both output voltage and current can be remotely monitored by using SCPI commands via either the RS 232 or GPIB ports.

**TABLE 1. BOP 1KW-G MODEL PARAMETERS**

Model (1)	d-c Output Range		Closed Loop Gain		Output Impedance			
	Voltage (2) (V d-c)	Current (A d-c)	Voltage Channel $G_V$ (V/V)	Current Channel $G_I$ (A/V)	Voltage Mode (Series R - L)		Current Mode (Parallel R - C)	
					$R_{d-c}$ (mOhms)	L ( $\mu$ H)	$R_{d-c}$ (Ohms)	C ( $\mu$ F)
1000 WATT MODELS								
BOP 6-125G	0 to $\pm 6$	0 to $\pm 125$	0.6	12.5	0.05	1.5	24	1150
BOP 10-100G	0 to $\pm 10$	0 to $\pm 100$	1.0	10.0	0.1	2.0	50	1100
BOP 10-75G	0 to $\pm 10$	0 to $\pm 75$	1.0	7.5	0.13	2.0	67	976
BOP 20-50G	0 to $\pm 20$	0 to $\pm 50$	2.0	5.0	0.40	8.3	200	371
BOP 25-40G	0 to $\pm 25$	0 to $\pm 40$	2.5	4.0	0.63	15.8	313	165
BOP 36-28G	0 to $\pm 36$	0 to $\pm 28$	3.6	2.8	1.30	25	640	103
BOP 50-20G	0 to $\pm 50$	0 to $\pm 20$	5.0	2.0	2.50	50	1250	55
BOP 72-14G	0 to $\pm 72$	0 to $\pm 14$	7.2	1.4	5.14	104	2570	33
BOP 100-10G	0 to $\pm 100$	0 to $\pm 10$	10.0	1.0	10.0	163	5000	16
(1) Models with G suffix include GPIB and RS 422 digital interfaces. .								
(2) When connecting active loads, the steady-state voltage of the active load must not exceed the maximum voltage rating of the BOP. Otherwise the overvoltage protection will shut down the power supply.								

## II — UNPACKING

This instrument has been thoroughly inspected and tested prior to packing and is ready for operation. After careful unpacking, inspect for shipping damage before attempting to operate. Perform the "Preliminary Operational Check" on page 5. If any indication

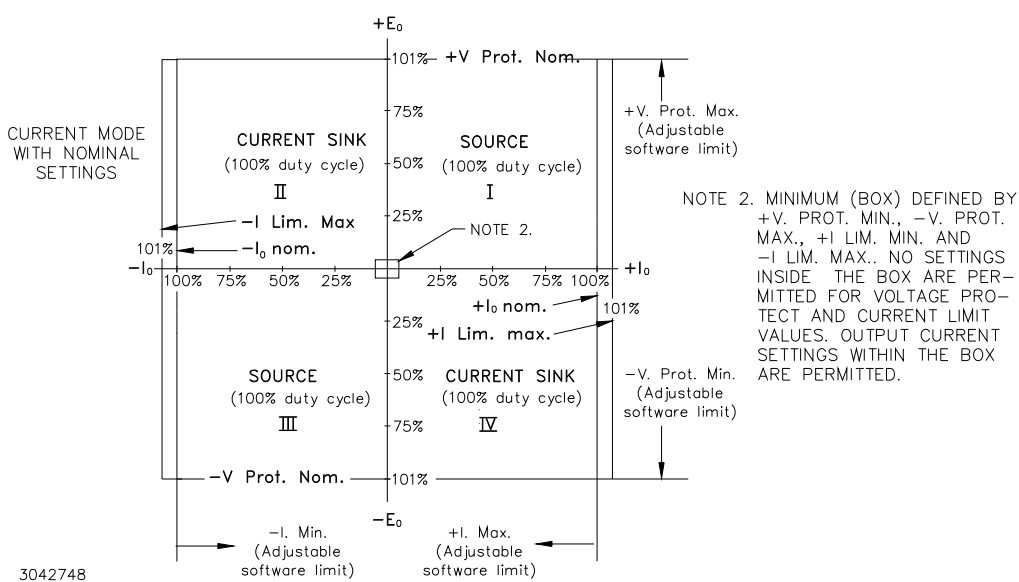
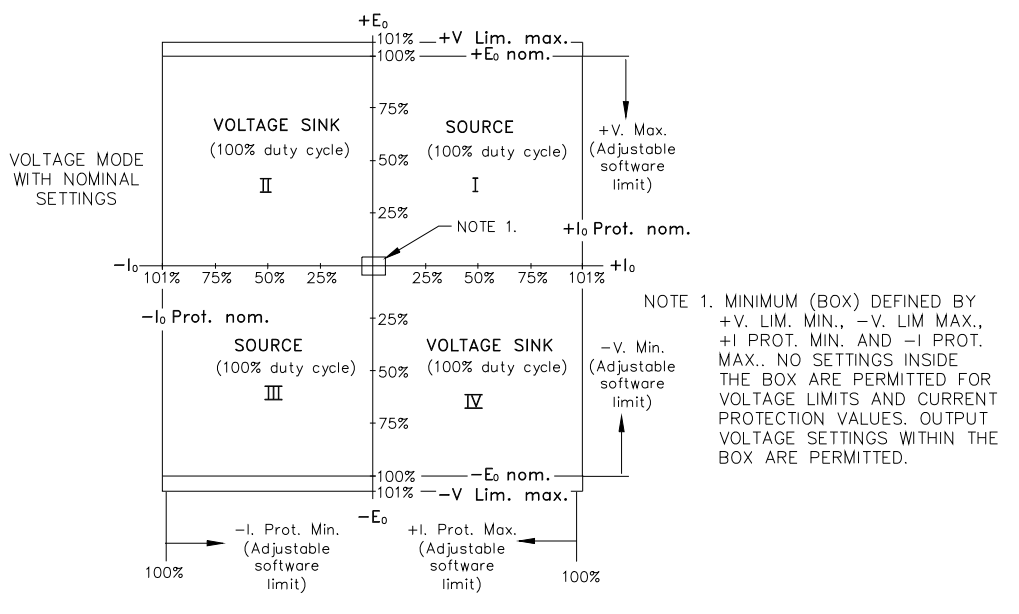
of damage is found, file an immediate claim with the responsible transport service.

## III — EQUIPMENT SUPPLIED

See Table 2.

**TABLE 2. EQUIPMENT SUPPLIED**

ITEM	FUNCTION	PART NUMBER
Source Power Entry mating connector	Mates with source power entry connector	142-0381 (Kepco) (IEC 320)
PAR/SER CONTROL - IN mating connector	Mates with PAR/SER CONTROL - IN port to allow access to pins required for calibration	142-0488 (Kepco)
Mating Connector, Trigger	Mates with Trigger port.	142-0527 (Kepco) SP2501 (CUI Stack)
Mating Connector, Analog I/O Port (15-pin DSUB Connector)	Mates with connector for Analog I/O port A2A5J6 Dsub 15 pin hood  Dsub 15 pin male	108-0374 (Tyco-Amp 207470-1) 142-0449 (Amphenol 17S-DA15P)



**FIGURE 1. BOP-G OUTPUT CHARACTERISTICS**



IV — ACCESSORIES See Table 3.

**TABLE 3. ACCESSORIES**

ITEM	FUNCTION	PART NUMBER
Mating Connector, Trigger	Mates with Trigger port.	142-0527 (Kepco) SP2501 (CUI Stack)
IEEE 1118 (BITBUS) Mating connector	Allows connection to IEEE 1118 (BITBUS) port.	142-0485 (Kepco) KMDLA-5P (Kyon Inc.)
IEEE 488 Cable, (1 meter long)	Connects BOP-G power supply to GPIB bus.	SNC 488-1
IEEE 488 Cable, (2 meter long)	Connects BOP-G power supply to GPIB bus.	SNC 488-2
IEEE 488 Cable, (4 meter long)	Connects BOP-G power supply to GPIB bus.	SNC 488-4
Line Cord (250V, 20A)	Provides connection to a-c mains via Nema 6-20P connector.	118-1087
Line Cord (250V, 20A)	Provides connection to a-c mains via Nema L6-20P locking type connector.	118-1088
RS 232 Cable Kit	Contains RJ11 to RJ45 Patch cord, RJ 45 Patch cord, two RS 232 adapters, one with male pins to connect to DTE equipment and one with female pins to connect to a PC (personal computer), two RS 232 Loop Back test Connectors (one 6-pin and one 8-pin) to test RS 232 communication and aid in isolating RS 232 communication problems.	KIT 219-0436
RS 232 Adapter (Male pins)	Allows RS 232 port to be connected to DTE equipment. (Supplied in KIT 219-0436.)	142-0487 (L-COM RA098M)
RS 232 Adapter (Female pins)	Allows RS 232 port to be connected to a PC (personal computer). (Supplied in KIT 219-0436.)	142-0506 (L-COM RA098F)
15-pin DSUB Connector	Mating connector for Analog input connector A2A5J6 Dsub 15 pin hood Dsub 15 pin male	108-0374 (Tyco-Amp 207470-1) 142-0449 (Amphenol 17S-DA15P)
IDC 6-pin connector	Mating connector for RS-232 PORT, connector A1J5 and PROTECTION EXT. PORT, connector A2A5J7	142-0536 (Amphenol 5-555176-3)
IDC 8-pin plug	Mating connector for PAR/SER PROTECT PORT (IN and OUT) connectors.	142-0535 (Amphenol 5-555176-3)
Slides	Allows easy withdrawal of unit from rack (Model CS 04 includes slides, brackets, all mounting hardware and installation instructions.)	CS 04
Heat Sink	Provides adequate cooling for calibration sense resistors.	136-0451
Output Terminal Cover	Protects against inadvertent contact with output and barrier strip terminals	129-0423

V — SAFETY See Table 4

**TABLE 4. SAFETY SYMBOLS**

SYMBOL	MEANING
	CAUTION: RISK OF ELECTRIC SHOCK.
	CAUTION: REFER TO REFERENCED PROCEDURE.
WARNING	INDICATES THE POSSIBILITY OF BODILY INJURY OR DEATH.
CAUTION	INDICATES THE POSSIBILITY OF EQUIPMENT DAMAGE.

## VI — PRELIMINARY OPERATIONAL CHECK

A simple operational check after unpacking and before equipment installation is advisable to ascertain whether the power supply has suffered damage resulting from shipping.

1. With POWER switch set to off position, connect the power supply to source power (see “Input Connections” below).
2. Verify that the power-up switches at the top cover are set to the factory default positions shown in Figure 5. This establishes GPIB address 6, stand-alone operation, Voltage mode, Analog Input enabled and internal  $\pm$ current limits enabled and set to maximum.

**NOTE:** The unit is shipped with load type set to Active (for inductive loads). To change the load type refer to the “Reset Power-up” on page 8. The logic for Remote on/off input at pin 2 of the Trigger port is set to high (1) or open circuit for output on, low (0) or short circuit for output off.

3. Connect a twisted wire pair (either #24 or #22 AWG) to the mating connector for the Analog I/O port pins 11 and 10. Connect +10V d-c  $\pm$ 0.1mV to pin 11, referenced to pin 10, then install the mating connector on the Analog I/O port at the rear panel.

## VII — INSTALLATION

Install units either on a bench or in a 19 inch-wide rack. For rack mounting: first remove four feet; rack must provide support at the rear. Optional slides may be used. Leave the front and rear panels clear of obstructions to ensure adequate cooling.

**INPUT CONNECTIONS.** Source power is connected to the power supply via three-wire input power using the source power mating connector supplied (see Table 3). This power supply operates from single phase a-c mains power (or between two phases of 3-phase a-c mains power), 230V, 50/60Hz nominal (range: 176 - 264V, 47-63Hz) without any need for range selection. The user must provide a properly sized and rated mains lead (line cord) and service with a current rating compatible with the required input current. Line cords available as accessories are listed in Table 3. Plug the source



### CAUTION:

**DO NOT repeatedly toggle the POWER circuit breaker/switch as this may damage the unit.**

4. Refer to “Input Connections.” on page 5 and connect the power supply to source power. With no load connected, set POWER switch to the ON position.
5. Each time the unit is turned on an internal self-test is performed. If the unit passes, it initializes with the power-up settings established in step 2 and the front panel POWER/FAULT/LIMIT light is green (power good), the DIGITAL CONTROL light is not lit (analog input enabled) and the VOLTAGE/CURRENT light is green (voltage mode), MASTER/SLAVE light is green (standalone or master configuration) and the OUTPUT ON light is lit (output enabled). If the front panel POWER/FAULT/LIMIT light is red, the unit has failed self-test; contact Kepco for further instructions. If the unit beeps, or the MASTER/SLAVE or VOLTAGE/CURRENT light blinks, refer to the BOP-G Operator Manual for troubleshooting.
6. Connect a digital voltmeter (DVM) with resolution and accuracy of 0.01% or better to the OUT S and COM S terminals at the rear panel terminal block.
7. Verify DVM voltage reading matches the nominal voltage (positive value) of the unit within 0.01% of rated maximum voltage.

power connector into the source power inlet connector at the rear panel.

### LOAD CONNECTIONS.



### CAUTION:

**Before connecting a load, verify that power up switch settings (see “Power-up Settings” on page 8) are compatible with your load.**

Power connections require wires that are properly rated for the nominal output current of the unit. Connect the load to the OUTPUT and COMMON power terminals on the rear panel (see Figure 3). OUT S and COM S terminal of the Monitor and Sensing Terminal block are for connection of remote sensing leads (after removing the factory-installed local

sensing links). **NOTE: Output Sense lines must be connected for proper operation, either locally, or at the load (remote).** Also use OUT S and COM S to monitor voltage at the load using external equipment such as a DVM, oscilloscope, etc. Use OUT MON and COM MON to monitor voltage at the BOP-G output.

**LOCAL SENSING (FACTORY DEFAULT).** Unit is shipped with local sensing links installed: OUT S connected to OUT MON and COM MON connected to COM S (see Figure 4A).

**REMOTE SENSING SELECT.** First remove the factory-installed local sensing links between OUT S and OUT MON and between COM MON and COM S. Then connect the OUT S and COM S lines at the load (see Figure 4B) using #22 AWG wire, twisted pair.

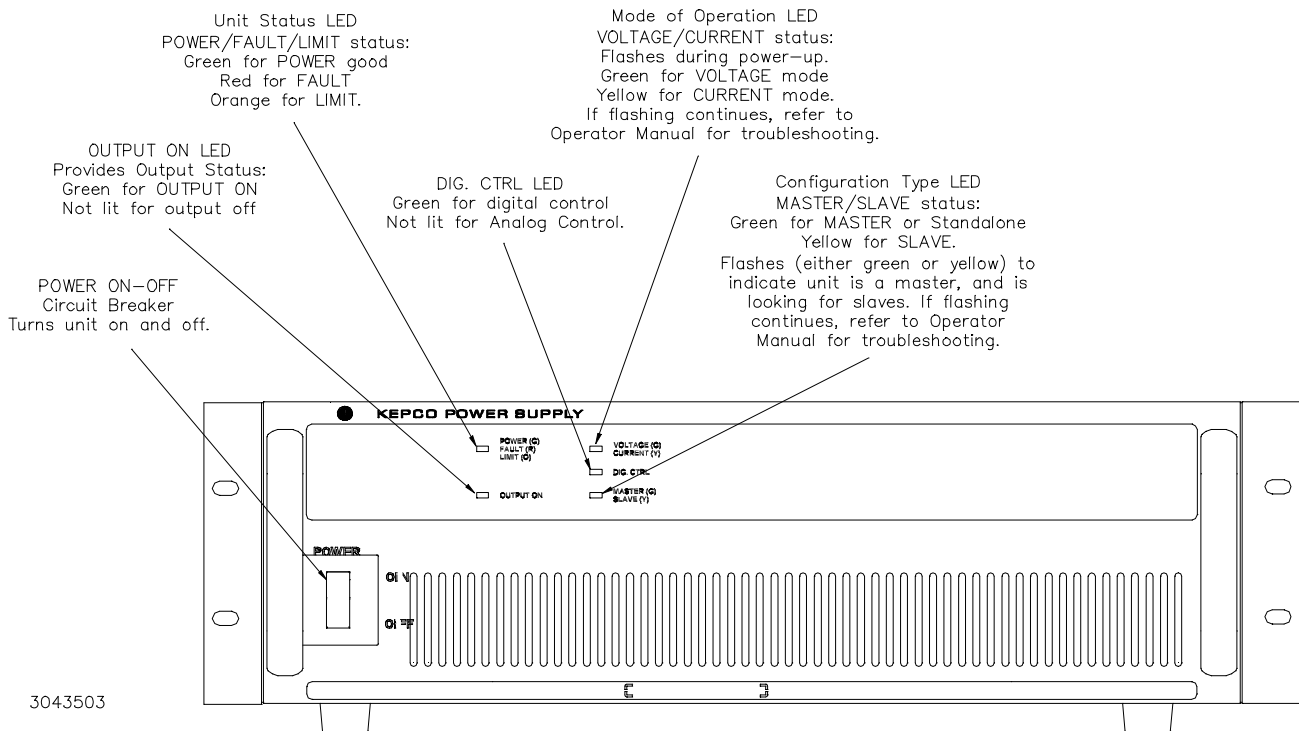
**ANALOG I/O CONNECTIONS.** The Analog I/O Port connector, located on the rear panel of the BOP-G 1KW power supply (see Figure 3), provides access to analog programming inputs which can control the mode of operation (voltage or current), output voltage or current, and establish positive and negative voltage and current limits. Output analogs

corresponding to output current and voltage are also provided. Refer to Operator's manual for details.

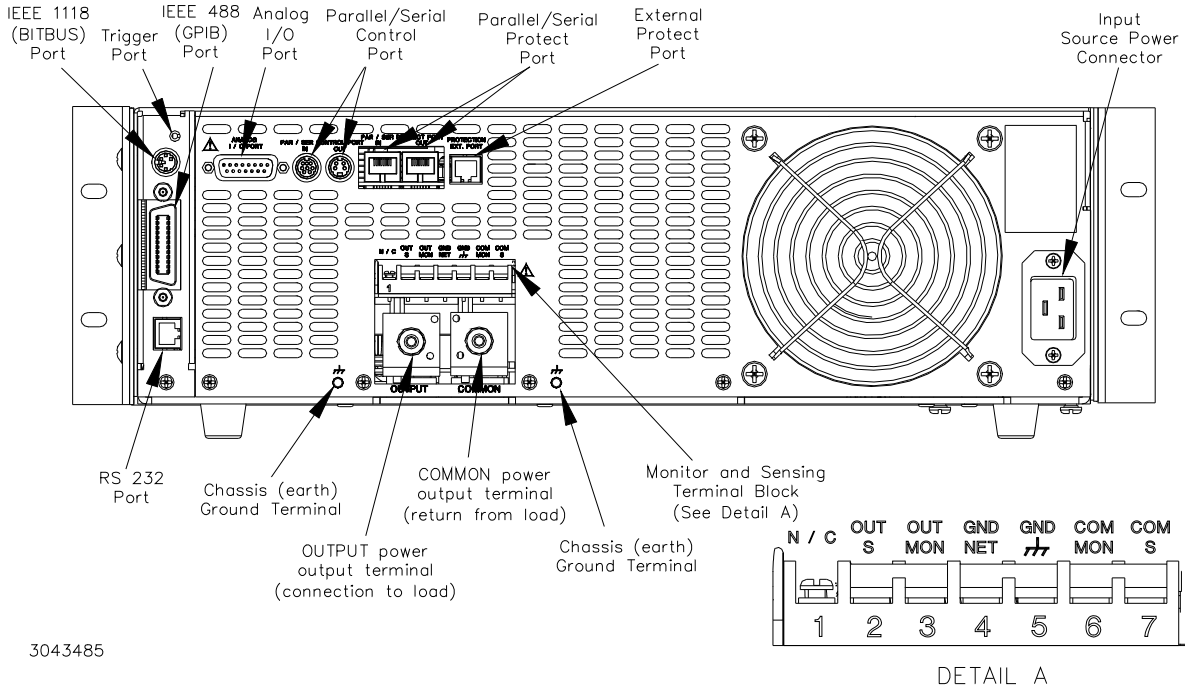
**TRIGGER CONNECTIONS.** The Trigger Port (see Figure 3) provides for an external trigger input for use with SCPI \*TRG and TRIG commands. Refer to Operator's manual for details.

**GPIB CONNECTIONS.** Your computer must have a GPIB interface card installed. Connect the power supply to the computer's GPIB interface card. Use a standard GPIB interface cable at the GPIB port on the rear panel (see Figure 3). The default GPIB address is 6; refer to the Operator's Manual to change it.

**RS 232 CONNECTIONS.** Connect the BOP-G to a modem using a Null Modem patch cable at the RS 232 port located on the rear panel (See Figure 3). A Null Modem cable is not required for older MAC computers with D-sub serial port in which the RXD and TXD line transposition is accomplished via external hardware. The baud rate (9600 or 19200) is established by performing a "Reset Power-up" on page 8.

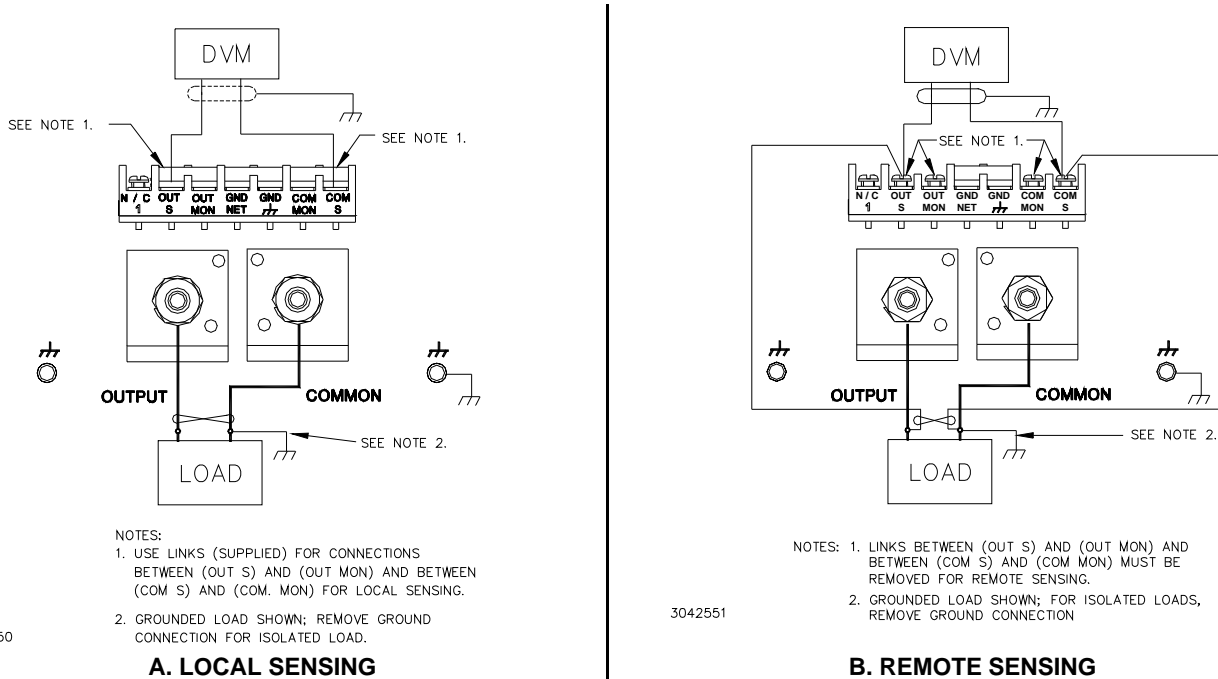


**FIGURE 2. BOP-G 1KW SERIES, FRONT PANEL CONTROLS AND INDICATORS**



3043485

**FIGURE 3. BOP-G 1KW SERIES, REAR PANEL VIEW, LINKS INSTALLED FOR LOCAL SENSING**



3042550

3042551

**FIGURE 4. LOAD CONNECTION**

## VIII — OPERATION

The user is urged to download the Operator's manual (see "Accessing Manuals." on page 1) for complete operating instructions. Some additional features covered in the Operator Manual are listed on page 13. In addition, the Operator's Manual also covers the GPIB and RS 232 interfaces, including the use of the drivers downloadable from:

[www.kepcopower.com/drivers/drivers-dl3.htm#bop1k](http://www.kepcopower.com/drivers/drivers-dl3.htm#bop1k)

**POWER-UP SETTINGS** Read this before connecting a load!

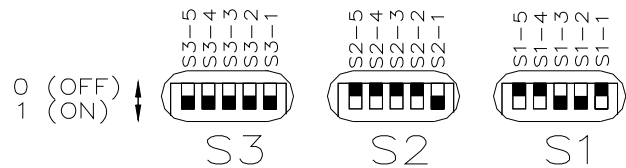


### CAUTION:

The unit will power-up as specified by the power-up switches (see Figure 5). Verify that these switch settings are compatible with your load. To change any default setting not covered by this guide, refer to the Operator's Manual.

**Default settings are in BOLD (other choices are in italics):**

- Load type **Active** (*Battery, Resistive*)
- **Standalone** configuration (*Master, Slave*)
- Analog Control **enabled** (*disabled*)
- **Voltage mode** (*Current mode*)
- Protection: **internal control, ± limit values at max** ( $1.01 \times E_{Onom}$  or  $I_{Onom}$ )
  - (*internal control, +limit values at maximum* ( $1.01 \times E_{Onom}$  or  $I_{Onom}$ ), *-limit values at minimum* (box))
  - (*internal control, -limit values at maximum* ( $1.01 \times E_{Onom}$  or  $I_{Onom}$ ), *+limit values at minimum* (box))
  - (*External protection limits*)
- RS 232 Baud rate **9600** (*19.2K*)
- **GPIB address 6** (*0 to 30*)
- Trigger port pin 2 remote on/off logic set for:
  - logic 1 or open = output enabled**, *logic 0 or short = output enabled*,
  - logic 0 or short = output disabled**, *logic 1 or open = output disabled*



S1: 00110 = GPIB ADDRESS 6  
 S2: 00001 = STANDALONE  
 S3: 11111 = VOLTAGE MODE, ANALOG INPUT ON,  
 ±V and ±C PROTECT MAX SET TO MAXIMUM

**FIGURE 5. TOP COVER POWER-UP SWITCHES, FACTORY DEFAULT SETTINGS**

### TURNING THE POWER SUPPLY ON.

The status of the unit upon power-up depends on the configuration of the three power-up switches (see Figure 5). Each power-up switch has five segments. For convenience the switch settings are often given for all segments; e.g., 00110 indicates segments 5, 4 and 1 are off (0) and segments 2 and 3 are on (1). In other instances a particular segment (e.g., S3-5) is specified.

**Reset Power-up** The reset power-up allows the power-up switches to establish 1) load type, 2) Remote On/off logic at Trigger port pin 2 and 3) RS 232 baud rate. The reset power-up also resets all limits to the factory default condition (overrides limit settings previously saved by MEM:UPD LIM command). If load type, baud rate and Trigger Port remote on/off logic do not need to be changed, refer to "Normal Power-up" on page 9.

1. With power off, refer to Figure 5 and set switches S1-1 through S1-5 to 1 (GPIB address to 11111) and set all S3 switches to 0.
2. Set S3 as follows to establish the load type upon power-up: S3-2 to 1 = Resistive Load, S3-3 to 1 = Active Load, S3-4 to 1 = Battery Load.
3. Set S3-1 to establish the baud rate for RS 232 operation: 1 = 19.2K, 0 = 9600.
4. Set S3-5 to 0 if desired to reverse the logic of the Remote On/Off signal at pin 2 of the External Trigger Port from the default (logic 1 = output enabled, logic 0 = output disabled) to logic 0 = output enabled, logic 1 = output disabled.
5. Do not change S2 settings.





**CAUTION:**

**DO NOT repeatedly toggle the circuit breaker/switch as this may damage the unit.**

6. Set POWER ON/OFF circuit breaker/switch on front panel to ON. If actuator does not lock when released, wait a few seconds before trying again. The circuit breaker is “trip-free” design; if overload exists, contacts cannot be held closed by actuator.
7. The unit will begin beeping on and off at equal intervals. Set POWER ON/OFF circuit breaker/switch on front panel to OFF and proceed to normal power-up (see below) to complete power-up configuration.

Normal Power-up The normal power-up establishes the operating mode of the unit, whether control will be analog or digital, whether the unit is standalone or part of a multi-unit configuration, and selects the GPIB address to be used.

1. With power off, set power-up switches S1, S2 and S3 as follows (see Figure 5):
  - a. Set S3 to 11111 to establish voltage mode, analog input on,  $\pm V$  Protect Max and  $\pm C$  Protect Max set to maximum (change S3-1 to 0 for current mode, change S3-4 to 0 for Analog Input off).
  - b. Set S2 to 00001 to select standalone operation.
  - c. Set S1 with valid GPIB address from 0 to 30. S1-1 through S1-5 is  $2^0$  through  $2^4$ . Default GPIB address is 00110 = 6.



**CAUTION:**

**DO NOT repeatedly toggle the circuit breaker/switch as this may damage the unit.**

2. Set POWER ON/OFF circuit breaker/switch on front panel to ON. If actuator does not lock when released, wait a few seconds before trying again. The circuit breaker is “trip-free” design; if overload exists, contacts cannot be held closed by actuator.

3. Unit performs self-test upon power-up initialization. If the unit passes self-test, the POWER/FAULT/LIMIT light turns green and the unit is ready for operation; if it fails, the light turns red.

POWER SUPPLY BASICS. When in Voltage mode, the power supply will (within the configured and rated limits) provide the programmed output voltage. Current is determined by the load, and cannot exceed the Current Protect limits. If the protect limit is reached, the POWER/FAULT/LIMIT LED light changes from green (power OK) to orange.

When in Current mode, the power supply will (within the configured and rated limits) provide the programmed output current. Voltage is determined by the load, and cannot exceed the Voltage Protect limits. If the protect limit is reached, the POWER/FAULT/LIMIT LED light changes from green (power OK) to orange.

VOLTAGE AND CURRENT PARAMETERS.

Table 5 defines the voltage and current parameters used in this manual and provides references to the SCPI commands and queries associated with the parameter.

SETTING VOLTAGE OR CURRENT MODE.

The BOP-G uses two separate channels, one to set output voltage or current and one to set the corresponding protection limit. The main channel is determined by the power-up switches during normal power-up:

Voltage Mode: S3-5 = 1, S3-1 = 1

Current Mode: S3-5 = 1, S3-1 = 0

The protection channel is determined automatically by the main channel selected. When Voltage mode is selected, the current protection channel is in use, and when Current mode is selected, the Voltage protection channel is in use.

**TABLE 5. VOLTAGE AND CURRENT PARAMETER DEFINITIONS**

Term	Definition	Associated SCPI command/query
+E <sub>Onom</sub> -E <sub>Onom</sub>	The nominal (rated) output voltage of the unit determined by model; e.g. for a BOP 36-28G, ±E <sub>Onom</sub> is 36V.	N/A
+I <sub>Onom</sub> -I <sub>Onom</sub>	The nominal (rated) output current of the unit determined by model; e.g. for a BOP 36-28G, ±I <sub>Onom</sub> is 28A.	N/A
+Voltage -Voltage	<b>Voltage mode only.</b> Positive (+) and negative (-) output voltage values established by remote command. Range (+): 0 to +Voltage max Range (-): 0 to -Voltage min	VOLT
+Voltage max -Voltage min	<b>Voltage mode only.</b> Maximum (positive) and minimum (maximum negative) voltage that can be set. Value (+): 0 to +E <sub>Onom</sub> Value (-): 0 to -E <sub>Onom</sub>	VOLT:LIM:[BOTH] VOLT:LIM:NEG VOLT:LIM:POS
+Current Protect -Current Protect	<b>Voltage mode only.</b> Defines maximum (+) current and Minimum (maximum negative) (-) that unit can source or sink. Range (+): +Current Protect min to +Current Protect max Range (-): -Current Protect max to -Current Protect min	CURR:PROT CURR:PROT:NEG CURR:PROT:POS
+Current Protect Max -Current Protect Min	<b>Voltage mode only.</b> Maximum setting for +Current Protect and Minimum (maximum negative) setting for -Current Protect. Value (+): +Current Protect min to (1.01 x +Current max) Value (-): -Current Protect max to (1.01 x -Current min)	CURR:PROT:LIM CURR:PROT:LIM:NEG CURR:PROT:LIM:POS
Minimum (box) +Current Protect Min -Current Protect Max	<b>Voltage mode only.</b> Minimum (positive) setting for +Current Protect and maximum (maximum negative) setting for -Current Protect. Values of ±Current Protect between +Current Protect Min and -Current Protect Max (near zero) are not allowed. This zone (also referred to as the <b>minimum (box)</b> ) is automatically calculated by the BOP (see Figure 1).	N/A
+Voltage Protect -Voltage Protect	<b>Current mode only.</b> Maximum positive (+) and minimum (maximum negative) (-) voltage that can appear at the output. Range (+): +Voltage Protect min to +Voltage Protect max Range (-): -Voltage Protect max to -Voltage Protect min	VOLT:PROT VOLT:PROT:NEG VOLT:PROT:POS
+Voltage Protect Max -Voltage Protect Min	<b>Current mode only.</b> Maximum (positive) setting for +Voltage Protect and Minimum (maximum negative) setting for -Voltage Protect. Value (+): +Voltage Protect min to (1.01 x +Voltage max) Value (-): -Voltage Protect max to (1.01 x -Voltage min)	VOLT:PROT:LIM VOLT:PROT:LIM:NEG VOLT:PROT:LIM:POS
Minimum (box) +Voltage Protect Min -Voltage Protect Max	<b>Current mode only.</b> Minimum (positive) setting for +Voltage Protect and maximum (maximum negative) setting for -Voltage Protect. Values of ±Voltage Protect between +Voltage Protect Min and -Voltage Protect Max (near zero) are not allowed. This zone (also referred to as the <b>minimum (box)</b> ) is automatically calculated by the BOP (see Figure 1).	N/A
+Current -Current	<b>Current mode only.</b> Positive and negative output current established by remote command. Range (+): 0 to +Current max Range (-): 0 to -Current min	CURR
+Current max -Current min	<b>Current mode only.</b> Maximum (positive) and minimum (maximum negative) current that can be set. Value (+): 0 to +I <sub>Onom</sub> Value (-): 0 to -I <sub>Onom</sub>	CURR:LIM CURR:LIM:NEG CURR:LIM:POS

## VOLTAGE/CURRENT PROTECT LIMITS.

These values are the references for the complementary channels: voltage in current mode and current in voltage mode. The range for these values is between a minimum (box) value (see Figure 1) and 1% above the rated nominal value. If the unit is in voltage mode, it will enter current protect mode when the load demands more current and energy than permitted by the  $\pm$ current protect settings. Similarly, if the unit is in current mode, it will enter voltage protect mode if the load demands more voltage and energy than permitted by the  $\pm$ voltage protect settings. When the protect settings are exceeded, the protection channel limits the output current or voltage, the POWER/FAULT/LIMIT LED lights orange (LIMIT), and the power supply continues operation in the complementary mode of operation.

The BOP can be configured to program the protection limits as a single value that applies to both protection channels (using CURR:PROT:LIM or VOLT:PROT:LIM) or by individual commands: (CURR:PROT:LIM:POS, CURR:PROT:LIM:NEG, VOLT:PROT:LIM:POS, VOLT:PROT:LIM:NEG) to program individual settings for positive and negative protection limits.

**SOFTWARE LIMITS.** The software limits for the main channels (+Voltage Max, -Voltage Min, +Current Max and -Current Min) are the maximum (positive) and minimum (Maximum negative) values allowable for voltage and current. The default software limits are determined by the model: the nominal (rated) values for voltage and current (e.g., 36V and 28A for the BOP 36-28G). These four values can be adjusted independently. For example, a BOP 36-28G, capable of delivering  $\pm 36V$  in voltage mode can be configured to allow voltage to be adjusted only from -1V to +15V by setting -Voltage Min to -1 and +Voltage Max to +15. This can be done by sending VOLT:LIM:POS 15 and VOLT:LIM:NEG 1 commands via either GPIB or RS 232 ports.

**NOTE:** If main channel software limits are changed from the default, the corresponding protection limits are automatically set to 1% above the new maximum value. The complementary software limits are unchanged - they must be changed manually if needed.

**MAXIMUM/MINIMUM PROTECTION LIMITS (SOFTWARE-CONTROLLED).** The  $\pm$  protection limits are software limits that establish the maximum and minimum (maximum negative) allowable levels of output voltage in current mode and current in voltage mode. The default protection limits are 1% above  $E_{Omax}$  or 1% above  $I_{Omax}$ .



### CAUTION:

**When working with active loads, always adjust the BOP protection limits to be above the maximum values of voltage or current expected from the load. For example, when the BOP is operating in voltage mode sinking energy from a constant current type load, set the current protection limits of the BOP above the maximum current expected from the load.**

The protect channel limits are +V (voltage) Protect max, -V Protect min, +C (current) Protect max and -C Protect min (see Table 5); these prevent the unit from sourcing or sinking voltage or current that exceeds these settings. In voltage mode the current protect channel is clamped to the limit value; in current mode the voltage protect channel is clamped to the limit value. Adjustment range is between a minimum (box) value (see Figure 1) and 1% above the nominal (rated) value.

**DETERMINING HOW THE UNIT RESPONDS WHEN OUTPUT IS OFF (LOAD TYPE).** The BOP-G supports three Load Type selections which determine how the power supply responds when the output is off: ACTIVE, RESISTIVE and BATTERY (see Table 6). The Load Type selection does not affect the settings of the power supply for ON state; it only affects the main internal reference level and the protection levels during the OFF state. Load type is selected by performing a Reset Power-up or by using the OUTP:MODE command.

**TABLE 6. POWER SUPPLY BEHAVIOR WHEN OUTPUT IS SET TO OFF**

LOAD TYPE SETTING	If unit was in Voltage Mode when output OFF command issued.	If unit was in Current Mode when output OFF command issued.
ACTIVE	<ul style="list-style-type: none"> <li>• Unit remains in voltage mode.</li> <li>• Voltage set to zero.</li> <li>• Both ± Current Protect set to maximum.</li> <li>• Both ± Voltage Limit remain at maximum.</li> </ul>	<ul style="list-style-type: none"> <li>• Unit set to voltage mode.</li> <li>• Voltage set to zero.</li> <li>• Both ± Current Protect remain at maximum.</li> <li>• Both ± Voltage Limit set to maximum.</li> </ul>
RESISTIVE	<ul style="list-style-type: none"> <li>• Unit remains in voltage mode.</li> <li>• Voltage set to zero.</li> <li>• Both ± Current Protect set to minimum box values.</li> <li>• Both ± Voltage Limit remain at maximum.</li> </ul>	<ul style="list-style-type: none"> <li>• Unit remains in current mode.</li> <li>• Current set to zero.</li> <li>• Both ± Current Protect set to minimum box values.</li> <li>• Both ± Voltage Limit set to maximum,</li> </ul>
BATTERY	<ul style="list-style-type: none"> <li>• Unit set to current mode.</li> <li>• Current set to zero.</li> <li>• Both ± Voltage Protect remain at maximum.</li> <li>• Both ± Current Limit set to maximum.</li> </ul>	<ul style="list-style-type: none"> <li>• Unit remains in current mode,</li> <li>• Current set to zero.</li> <li>• Both ± Voltage Protect set to maximum.</li> <li>• Both ± Current Limit remain at maximum.</li> </ul>



**WARNING**

For inductive loads, and especially superconducting magnet type loads, the inherent offset of the BOP-G in the OFF state may generate significant current in the circuit. Two properly rated external switches must be installed for safety: One in series between the magnet and the BOP output, and the other in parallel with the magnet. Once the output voltage and current measurements at the output read 0V, 0A, close the parallel switch and open the series switch before removing or installing connections between BOP and load. To restore operation, first close the series switch, then open the parallel switch

**Active.** Active mode (default setting) is necessary for the power supply to function properly and safely with inductive loads and constant-current-type active electronic loads. Active mode can also be used with resistive loads. Table 6 indicates how the power supply responds to a command to go from Output ON to OFF. When the output is disabled, the unit is set to voltage mode, voltage is set to zero and both current protect and voltage limit are set to maximum. When the unit is enabled, the pre-existing settings for voltage, current protect and voltage limit are restored.



**WARNING**

For both inductive loads and constant-current-type active electronic loads, when the BOP-G output is set to OFF, a path is provided for absorbing either the energy accumulated in the reactance of the load during the ON state, or energy delivered by an electronic load. This prevents damage to the load and power supply as well as providing safety for the user. However, in addition to the built-in safety features, constant-current-type active electronic loads must be adjusted to zero and voltage and current measurements at the output must read 0V, minimum current, before handling the power supply-to-load connections.

**Resistive.** This mode, as the name suggests, is useful for resistive loads. Table 6 indicates how the power supply responds to a command to go from Output ON to OFF.



## WARNING

Accessing the BOP-G after the output is disabled in BATTERY mode is hazardous because (1) high current arcing is possible and (2) either the external battery voltage, or the voltage ( $\pm$ Voltage Protection max) on the BOP-G output terminals may be dangerous. Therefore, for battery and constant-voltage-type active electronic loads it is recommended that two properly rated external switches be installed for safety: one in series with the battery, and one across the BOP-G output. After the unit is set to OFF, first open the switch in series with the battery, then close the switch across the BOP-G output to ensure safety before handling BOP-G connections. When connecting the battery, the switch across the output should be opened after the connections are complete and then the switch in series with the battery should be closed. If the constant-voltage-type active electronic load is adjusted to zero before handling the power supply-to-load connections, only the switch across the BOP-G output is required.

**Battery.** This mode is necessary for the power supply to function properly and safely with either battery or constant-voltage-type active electronic loads. This mode prevents the battery from discharging during the OFF state. When the output is disabled (set to OFF), the BOP-G will go to current mode, current will be set to zero, with voltage protect and current

limit set to maximum. In this way the battery will not be discharged while the output is OFF. For constant-voltage-type active electronic loads this mode stops energy flow during the OFF state. Table 6 indicates how the power supply responds to a command to go from Output ON to OFF.

CONFIGURE LOAD TYPE. To configure, perform "Reset Power-up" on page 8 and change S3 as desired.

### ENABLING/DISABLING OUTPUT POWER.

The behavior of the unit when disabled depends on the Load Type setting (see Table 6 for details). There are four ways to disable the output, refer to Operator Manual for details:

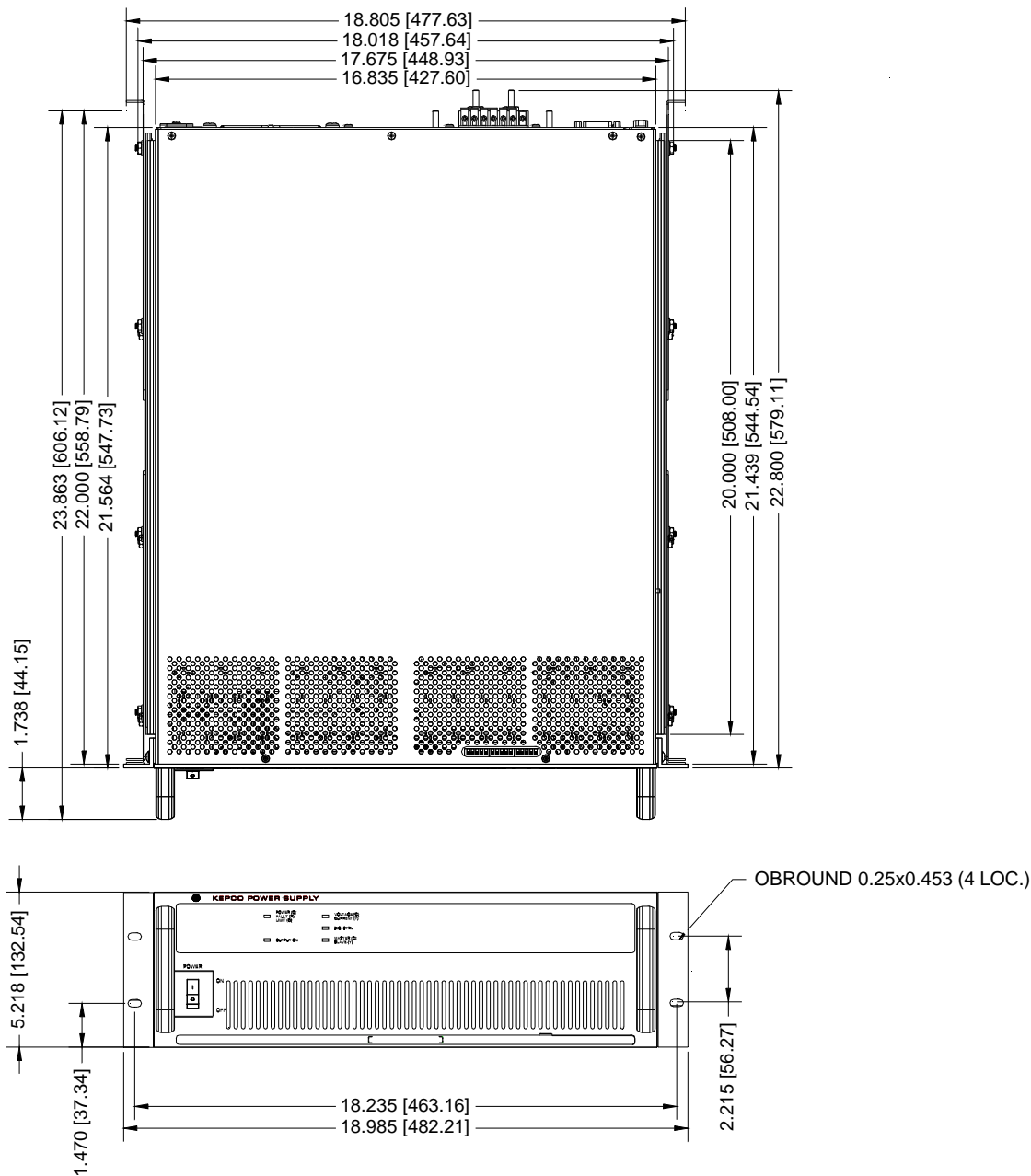
1. Using Remote Shutdown pin 2 (referenced to pin 1) of the Protection Ext. port. This faults the unit, and requires the unit to be turned off, then on in order to restore operation.
2. Using Remote On-Off at pin 2 (referenced to pin 1) of the Trigger port which sets the output to off (disabled) or on (enabled) by toggling a signal applied to the Trigger port. This requires sending either:
  - a. OUT:CONT:HIGH: output on if pin 2 open or high, output off if pin 2 shorted or low.
  - b. OUT:CONT:LOW: output on if pin 2 shorted or low, output off if pin 2 open or high.
3. Using Remote On-Off at pin 2 (referenced to pin 1) of the Trigger port to disable the output and the digital command OUTP ON to enable the output. This requires first sending OUTP:CONT:STAN command.
4. Using digital commands OUTP OFF and OUTP ON to disable and enable the output. This requires first sending OUTP:CONT:STAN command.

## IX — ADDITIONAL FEATURES

The user is urged to refer to the Operator's Manual for full explanations of all BOP-G 1KW features, including:

- Changing the Default Power up Settings.
- Remote Shutdown.
- Digital Remote Operation - using SCPI commands via RS 232 or GPIB ports.
- Analog Remote Operation - via Analog I/O port.
- Details about Protect Limits and Software-controlled limits.
- Storing/Recalling Power Supply Output Settings.
- Waveform Generation - Sine, Triangle,  $\pm$ Ramp, Square and Level segments. Remote operation allows 1 waveform, maximum of 126 segments using LIST commands.
- Operator Testing.

- Calibration - via remote SCPI commands.
- Parallel/Series Configurations -increase current capability, voltage capability, or both.

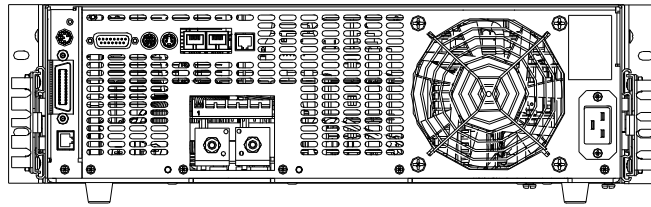


NOTES:

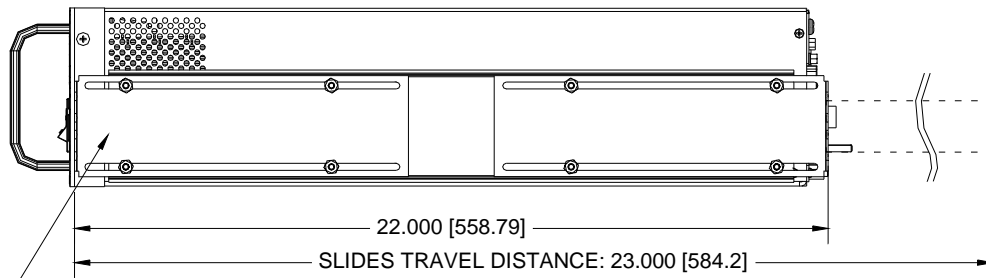
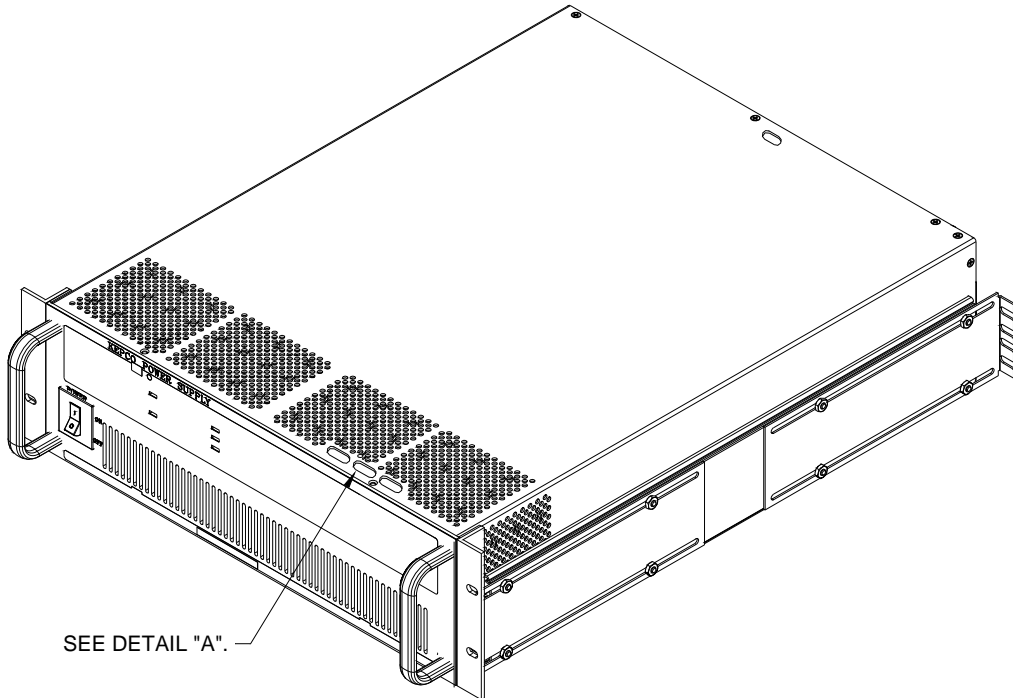
- MATERIAL: A) CHASSIS: #11 GA. C.R.S.  
 B) FRONT PANEL: 1/8 THICK 6061-T6 ALUMINUM.  
 C) COVER: #16 GA. C.R.S.  
 D) BACK PLATE: 0.064 THICK 5052-H32 ALUMINUM.
- FINISH: A) CHASSIS & COVER : CADMIUM PLATE WITH CROMATE WASH.  
 B) BACK PLATE: IRIDITE GOLD  
 C) FRONT PANEL: SEE 1311145 PAGE 2 OF 3.
- DIMENSION IN PARENTHESES ARE IN MILLIMETERS.
- TOLERANCES ARE  $\pm 1/32$  (0.8), EXCEPT AS NOTED.
- PRIOR TO INSTALLATION, REMOVE FOUR FEET.
- OPTIONAL SLIDES (KEPCO KIT P/N CS 04) SHOWN INSTALLED.

3043424

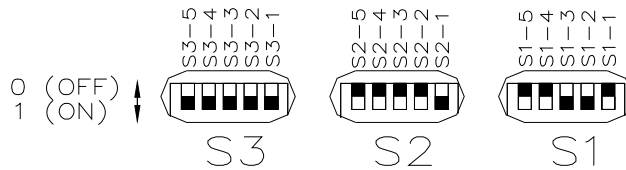
**FIGURE 6. BOP 1KW OUTLINE DIMENSIONS (SHEET 1 OF 2)**



REAR VIEW



SEE NOTE 6.



DETAIL "A"

3043424

FIGURE 6. BOP 1KW OUTLINE DIMENSIONS (SHEET 2 OF 2)

